

## C 343 2012 Cap, Thermostat Catalog

### Product Application Section

New Stant products.....2  
Stant XACTstat™ features .....7  
Unique Stant cap features.....8  
Stant InStant Fill Caps.....10  
Stant Swiv-el and Lev-R-Vent Caps.....10  
Stant Racing Radiator Caps.....11  
Stant Low Pressure Radiator Caps.....11

Cap Applications.....Caps 1 - 162

Thermostat Applications.....Thermostats 1 - 80

### Buyers Guide

Numerical listings.....Buyers Guide 1 - 15  
Caps Illustrations.....16  
12270 Radiator Pressure Tester.....34  
12260 Vacuum Tester.....35  
12265 Fuel System Tester.....35  
Cooling System Tester Adapters.....36  
Cooling System Tester Repair Parts.....39  
Fuel Cap Testers, Adapters and Repair Parts.....40  
Thermostat Installation Instructions.....45  
Gasket and Seal Illustrations.....50  
Thermostat Photographs.....51

# New Items



**10268** - 5# Radiator cap for 2011 and up Ford Superduty's



**10269** - 18# Coolant Recovery cap for 2010 and up General Motors



**10270** - 10# Coolant Recovery cap for Navistar



**10271** - 20# Coolant Recovery cap for 2010 and up General Motors



**10524/17524** - Ford "Capless" locking plug for 2009 and up and keyed alike version



**10852** - Fuel cap for 1963-74 Chevy Corvette's - sealed



**10853** - Fuel cap for 1963-74 Chevy Corvette's - vented

**14368** - Alternate temperature thermostat  
for Jeeps



**15112** - Nissan 2nd thermostat



**15138** - Nissan 2007-2010  
Nissan Sentra and Versa



**48799** - Dodge Hemi



**49098** - Volkswagen Golf 2006-  
2008



**49212, 49218, 49219** - 2009-2011  
Rams w/Cummins 6.7L Diesel

**49229** - 2011-2012 Ford F150  
w/5.0L



# New Items

**49238** - 2011-2012 Ford F-150 and  
Mustang w/ 3.5L & 3.7L



**49240** - 2011-2012 Ford Superduty's  
w/ 6.7L



**49249** - 2002-2008 BMW 545's



**49258** - 2013-2006 Dodge Sprinter



**49269** - 2007-2010 BMW 328i



**49279** - 2004-2008 Suzuki Forenza

**49288** - 2004-2008 Suzuki Forenza

**12426** - Fuel Cap Tester Adapter  
for BMW's and Mercedes



**25298**- GM's and Saturn Vue

**25299**- Chrysler

**25300**- 2011-2012 Ford F-150's

# Unique Features

## Stant XACTstat™ Thermostats

- Designed for customers that demand exact OEM replacement thermostat
- Currently more than 100 XACTstats™ and growing
- XACTstat™ matches OEM product with fit, design and features
- Features include:
  - Jiggle Pins
  - Check Valves
  - Integral Seals
  - Ports for attaching coolant sensors
  - Integrated water outlet housings



Jiggle Pins



Check Valves



Integral Seals



Ports for attaching  
Coolant Sensors

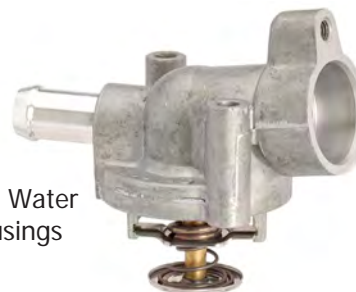

Integrated Water  
Outlet Housings

## Stant Fuel Caps

These safety features are found **ONLY** with Stant fuel caps

### OE Pressure Relief

- Prevents fuel vapors from exiting the fuel system under normal operating conditions
- Allows an escape path for pressure in an impact situation where the fuel tank has collapsed
- Permits pressure to escape in the event of a Vapor Management System malfunction such as a plugged vent line.



### OE Vacuum Relief

- Prevents fuel vapors from exiting the fuel system via the fill tube under normal operating conditions
- Allows an alternative path for air to flow into the fuel tank in the event that there is an obstruction in the Vapor Recovery and/or Vapor Management Systems
- Permits fuel system to normalize during natural vacuum situations. For example, a hot fuel tank being cooled down by a drive through car wash.

# Unique Features

## **Stant Fuel Caps**

**These safety features are found ONLY with Stant fuel caps**

### **Lost Motion**

- During a crash the cap handle is allowed some freedom to rotate (from 60° to 180°) while maintaining proper O-ring compression
- Aids in the prevention of potential fuel leakage in a crash or impact

### **Torque override**

- Aids in proper installation of fuel cap
- Provides audible "click" for customer
- Allows for proper O-ring compression

### **Breakaway Groove**

- Allows for O-ring to maintain proper compression during a crash or impact even if some of the cap is broken away
- Prevents potential fuel leakage during a crash or impact



## Stant Caps

### Keyed Alike Locking Caps

- Stant offers a complete line of locking fuel caps that are keyed alike.
- For the consumer that has more than one vehicle and wants the protection of a locking fuel cap without the inconvenience of having to carry several keys.
- For small or large fleets.



### Pre-Vent, Regular and Locking Fuel Caps

- Changing fuel formulations have increased fuel volatility and vapor pressure.
- An added feature in the Pre-vent cap allows a controlled release of fuel tank pressure as the cap begins to open.
- Depressurizes fuel system before the sealing gasket is lifted from the filler neck.
- Dramatically reduces the possibility of fuel expulsion onto hands and clothes.



# Unique Features

## Instant Fill Fuel Caps

- Easy to install
- Unique trapdoor mechanism works with most fueling nozzles
- Eliminates the need to remove and replace fuel cap
- No twist appeals to arthritic customer
- No touch appeals to the "clean hands" customer
- Meets OBD specifications and will not turn on "Check Engine" light



## Swiv-el Radiator Caps

- Designed for easier installation and removal than traditional radiator caps



## Lev-R-Vent pressure Caps

- Designed to fit in close quarters
- Patented lever releases pressure safely for quicker cooling



## Stant Racing Radiator Caps

The Stant racing radiator caps are specialty parts for use on high performance cooling systems.

**Warning - These are high pressure radiator caps are made for use on race cars only. Do not use them on a passenger car. Pressure test the complete cooling system to the maximum level of pressure indicated on the box. Failure to test the cooling system to the proper pressure, prior to installing the cap, may result in damage to the cooling system or bodily injury.**

**10361 (19-21 pounds), 10362 (22-24 pounds), 10363 (28-32 pounds)**

Mini Race cap, both include upper gasket for use on open and closed cooling systems.



**10371 (18-22 pounds), 10372 (21-25 pounds), 10373 (28-32 pounds)**

Standard SAE "A" size, does not include upper gasket so they are for use on open cooling systems only.



**10381 (18-22 pounds), 10382 (21-25 pounds)**

Stant Lev-R-Vent style that is Standard SAE "A" size, does include upper gasket so they are for use on open and closed cooling systems.



**10391 (18-22 pounds), 10392 (21-25 pounds), 10393 (28-32 pounds), 10394 (38-42 pounds)**

Stant Lev-R-Vent style that is Standard SAE "A" size, does include upper gasket so they are for use on open and closed cooling systems.



## Stant Low Pressure Racing Radiator Caps

Part No.	#'s	Part No.	#'s	Part No.	#'s	Part No.	#'s
18227	13	18231*	16	18242	16	18330	16
18229*	13	18233*	16	18327	13	18331	16
18230*	16	18241	13	18329	13	18333	16

\*Octagonal Cap



# Caps for Passenger Cars and Light Trucks (1990 and Newer)

Application	Part Number	PSI	Application	Part Number	PSI
<b>Acura</b>			<b>Acura - Continued</b>		
<b>CL</b>			<b>MDX - Continued</b>		
<b>4-Cyl. 2.2 L</b>			<b>V-6 3.7 L</b>		
1997; OE Type Radiator Cap .....	10242	16	2011-2007; OE Type Radiator Cap .....	10242	16
1997; OE Equivalent Fuel Cap .....	10834		2011-2007; OE Equivalent Fuel Cap .....	10837	
1997; Regular Locking Fuel Cap .....	10504		2011-2007; Regular Locking Fuel Cap .....	10507	
1997; Oil Filler Cap .....	10081		2011-2007; Oil Filler Cap .....	10134	
<b>4-Cyl. 2.3 L</b>			<b>NSX</b>		
1999-1998; OE Type Radiator Cap .....	10242	16	<b>V-6 3.0 L</b>		
1999-1998; OE Equivalent Fuel Cap .....	10834		2005-1995; Lev-R-Vent Radiator Cap .....	✓10333	16
1999-1998; Regular Locking Fuel Cap .....	10504		2005-1995; OE Type Radiator Cap .....	10233	16
1999-1998; Oil Filler Cap .....	10081		2005-1995; OE Equivalent Fuel Cap .....	10834	
<b>V-6 3.0 L</b>			2005-1995; Regular Locking Fuel Cap .....	10504	
1999-1997; OE Type Radiator Cap .....	10242	16	2005-1995; Oil Filler Cap .....	10081	
1999-1997; OE Equivalent Fuel Cap .....	10834		<b>V-6 3.2 L</b>		
1999-1997; Regular Locking Fuel Cap .....	10504		2005-1997; Lev-R-Vent Radiator Cap .....	✓10333	16
1999-1997; Oil Filler Cap .....	10081		2005-1997; OE Type Radiator Cap .....	10233	16
<b>V-6 3.2 L</b>			2005-1997; OE Equivalent Fuel Cap .....	10834	
2003-2001; OE Type Radiator Cap .....	10242	16	2005-1997; Regular Locking Fuel Cap .....	10504	
2003-2001; OE Equivalent Fuel Cap .....	10834		2005-1997; Oil Filler Cap .....	10081	
2003-2001; Regular Locking Fuel Cap .....	10504		<b>RDX</b>		
2003-2001; Oil Filler Cap .....	10134		<b>4-Cyl. 2.3 L</b>		
<b>EL</b>			2011-2007; OE Type Radiator Cap .....	10242	16
<b>4-Cyl. 1.6 L (Canada)</b>			2011-2007; OE Equivalent Fuel Cap .....	10837	
2000; OE Type Radiator Cap .....	10242	16	2011-2007; Regular Locking Fuel Cap .....	10507	
2000; OE Equivalent Fuel Cap .....	10834		<b>RL</b>		
2000; Regular Locking Fuel Cap .....	10504		<b>V-6 3.5 L</b>		
2000; Oil Filler Cap .....	10081		2008-2004; OE Type Radiator Cap .....	10242	16
<b>4-Cyl. 1.7 L (Canada)</b>			2008-2004; OE Equivalent Fuel Cap .....	10837	
2005-2003; OE Type Radiator Cap .....	10242	16	2008-2004; Regular Locking Fuel Cap .....	10507	
2005-2003; OE Equivalent Fuel Cap .....	10834		2008-2004; Oil Filler Cap .....	10134	
2005-2003; Regular Locking Fuel Cap .....	10504		2008-2004; Oil Filler Cap .....	10134	
2005-2003; Oil Filler Cap .....	10134		2003-2000; OE Type Radiator Cap .....	10242	16
2002-2001; OE Type Radiator Cap .....	10242	16	2003-2000; OE Equivalent Fuel Cap .....	10834	
2002-2001; OE Equivalent Fuel Cap .....	10834		2003-2000; Regular Locking Fuel Cap .....	10504	
2002-2001; Regular Locking Fuel Cap .....	10504		2003-2000; Oil Filler Cap .....	10134	
2002-2001; Oil Filler Cap .....	10081		1999-1996; OE Type Radiator Cap .....	10242	16
<b>Integra</b>			1999-1996; OE Equivalent Fuel Cap .....	10834	
<b>4-Cyl. 1.8 L</b>			1999-1996; Regular Locking Fuel Cap .....	10504	
2001-1995; OE Type Radiator Cap .....	10242	16	1999-1996; Oil Filler Cap .....	10081	
2001-1995; OE Equivalent Fuel Cap .....	10834		<b>V-6 3.7 L</b>		
2001-1995; Regular Locking Fuel Cap .....	10504		2010-2009; OE Type Radiator Cap .....	10242	16
2001-1995; Oil Filler Cap .....	10081		2010-2009; OE Equivalent Fuel Cap .....	10837	
<b>Legend</b>			2010-2009; Regular Locking Fuel Cap .....	10507	
<b>V-6 3.2 L</b>			2010-2009; Oil Filler Cap .....	10134	
1995; OE Type Radiator Cap .....	10242	16	<b>RSX</b>		
1995; OE Equivalent Fuel Cap .....	10834		<b>4-Cyl. 2.0 L</b>		
1995; Regular Locking Fuel Cap .....	10504		2006-2004; OE Type Radiator Cap .....	10242	16
1995; Oil Filler Cap .....	10081		2006-2004; OE Equivalent Fuel Cap .....	10837	
<b>MDX</b>			2006-2004; Regular Locking Fuel Cap .....	10507	
<b>V-6 3.5 L</b>			2006-2004; Oil Filler Cap .....	10134	
2006-2005; OE Type Radiator Cap .....	10242	16	2006-2004; Oil Filler Cap .....	10134	
2006-2005; OE Equivalent Fuel Cap .....	10837		2003-2002; OE Type Radiator Cap .....	10242	16
2006-2005; Regular Locking Fuel Cap .....	10507		2003-2002; OE Equivalent Fuel Cap .....	10834	
2006-2005; Oil Filler Cap .....	10134		2003-2002; Regular Locking Fuel Cap .....	10504	
2004-2002; OE Type Radiator Cap .....	10242	16	2003-2002; Oil Filler Cap .....	10134	
2004-2002; OE Equivalent Fuel Cap .....	10834		<b>SLX</b>		
2004-2002; Regular Locking Fuel Cap .....	10504		<b>V-6 3.2 L</b>		
2004-2002; Oil Filler Cap .....	10134		1997-1996; Lev-R-Vent Radiator Cap .....	✓10333	16
2001; OE Type Radiator Cap .....	10242	16	1997-1996; OE Type Radiator Cap .....	10233	16
2001; OE Equivalent Fuel Cap .....	10834		1997-1996; OE Equivalent Fuel Cap .....	10834	
2001; Regular Locking Fuel Cap .....	10504		1997-1996; Regular Locking Fuel Cap .....	10504	
2001; Oil Filler Cap .....	10081		1997-1996; Oil Filler Cap .....	10101	
<b>V-6 3.5 L</b>			<b>V-6 3.5 L</b>		
2006-2005; OE Type Radiator Cap .....	10242	16	1999; Lev-R-Vent Radiator Cap .....	✓10333	16
2006-2005; OE Equivalent Fuel Cap .....	10837		1999; OE Type Radiator Cap .....	10233	16
2006-2005; Regular Locking Fuel Cap .....	10507				
2006-2005; Oil Filler Cap .....	10134				
2004-2002; OE Type Radiator Cap .....	10242	16			
2004-2002; OE Equivalent Fuel Cap .....	10834				
2004-2002; Regular Locking Fuel Cap .....	10504				
2004-2002; Oil Filler Cap .....	10134				
2001; OE Type Radiator Cap .....	10242	16			
2001; OE Equivalent Fuel Cap .....	10834				
2001; Regular Locking Fuel Cap .....	10504				
2001; Oil Filler Cap .....	10081				

✓ Check Hood Clearance prior to installing this Cap.

## Caps for Passenger Cars and Light Trucks (1990 and Newer)

Application	Part Number	PSI	Application	Part Number	PSI
<b>Acura - Continued</b>			<b>AM General</b>		
<b>SLX - Continued</b>			<b>Hummer</b>		
<b>V-6 3.5 L - Continued</b>			<b>V-8 5.7 L</b>		
1999: OE Equivalent Fuel Cap .....	10834		1996: OE Equivalent Fuel Cap .....	10826	
1999: Regular Locking Fuel Cap .....	10504		1996: Regular Locking Fuel Cap .....	10596	
1999: Oil Filler Cap .....	10081		<b>V-8 6.5 L Diesel</b>		
1998: Lev-R-Vent Radiator Cap .....	✓10333	16	2001-1996: Lev-R-Vent Radiator Cap .....	10330	16
1998: OE Type Radiator Cap .....	10233	16	2001-1996: OE Type Radiator Cap .....	10230	16
1998: OE Equivalent Fuel Cap .....	10834		2001-1996: OE Equivalent Fuel Cap .....	10826	
1998: Regular Locking Fuel Cap .....	10504		2001-1996: Regular Locking Fuel Cap .....	10596	
1998: Oil Filler Cap .....	10101		2001-1996: Oil Filler Cap .....	10099	
<b>TL</b>			<b>Audi</b>		
<b>5-Cyl. 2.5 L</b>			<b>90</b>		
1998-1995: OE Type Radiator Cap; W/Nippondenso Rad. ....	10242	16	<b>V-6 2.8 L</b>		
1998-1995: Lev-R-Vent Radiator Cap; W/O Nippondenso Rad. .	✓10333	16	1995: OE Type Radiator Cap .....	10225	20
1998-1995: OE Type Radiator Cap; W/O Nippondenso Rad. ....	10233	16	1995: OE Equivalent Fuel Cap .....	10835	
1998-1995: OE Equivalent Fuel Cap .....	10834		1995: Regular Locking Fuel Cap .....	10505	
1998-1995: Regular Locking Fuel Cap .....	10504		1995: Oil Filler Cap .....	10079	
1998-1995: Oil Filler Cap .....	10081		<b>A3</b>		
<b>V-6 3.2 L</b>			<b>4-Cyl. 2.0 L</b>		
2008-2006: OE Type Radiator Cap .....	10242	16	2011: OE Type Radiator Cap .....	10249	22
2008-2006: OE Equivalent Fuel Cap .....	10837		2011: OE Equivalent Fuel Cap .....	10835	
2008-2006: Regular Locking Fuel Cap .....	10507		2011: Regular Locking Fuel Cap .....	10505	
2008-2006: Oil Filler Cap .....	10134		2010: OE Type Radiator Cap .....	10249	22
2005-2000: OE Type Radiator Cap .....	10242	16	2010: OE Equivalent Fuel Cap .....	10835	
2005-2000: OE Equivalent Fuel Cap .....	10834		2010: Regular Locking Fuel Cap .....	10505	
2005-2000: Regular Locking Fuel Cap .....	10504		2010: Oil Filler Cap .....	10079	
2005-2000: Oil Filler Cap .....	10134		2009-2006: OE Type Radiator Cap .....	10249	22
1999-1996: OE Type Radiator Cap .....	10242	16	2009-2006: OE Equivalent Fuel Cap .....	10827	
1999-1996: OE Equivalent Fuel Cap .....	10834		2009-2006: Regular Locking Fuel Cap .....	10597	
1999-1996: Regular Locking Fuel Cap .....	10504		2009-2006: Oil Filler Cap .....	10079	
1999-1996: Oil Filler Cap .....	10081		<b>4-Cyl. 2.0 L Diesel</b>		
<b>V-6 3.5 L</b>			2011: OE Type Radiator Cap .....	10249	22
2011: OE Type Radiator Cap .....	10242	16	2010: OE Type Radiator Cap .....	10249	22
2011: OE Equivalent Fuel Cap .....	10837		2010: OE Equivalent Fuel Cap .....	10837	
2011: Regular Locking Fuel Cap .....	10507		2010: Regular Locking Fuel Cap .....	10597	
2010: OE Type Radiator Cap .....	10242	16	2010: Oil Filler Cap .....	10079	
2010: Oil Filler Cap .....	10134		<b>V-6 3.2 L</b>		
2009-2007: OE Type Radiator Cap .....	10242	16	2009: OE Equivalent Fuel Cap .....	10827	
2009-2007: OE Equivalent Fuel Cap .....	10837		2009: Regular Locking Fuel Cap .....	10597	
2009-2007: Regular Locking Fuel Cap .....	10507		2009: Oil Filler Cap .....	10079	
2009-2007: Oil Filler Cap .....	10134		2008-2006: OE Type Radiator Cap .....	10249	22
<b>V-6 3.7 L</b>			2008-2006: OE Equivalent Fuel Cap .....	10827	
2011: OE Type Radiator Cap .....	10242	16	2008-2006: Regular Locking Fuel Cap .....	10597	
2011: OE Equivalent Fuel Cap .....	10837		2008-2006: Oil Filler Cap .....	10079	
2011: Regular Locking Fuel Cap .....	10507		<b>A4</b>		
2010-2009: OE Type Radiator Cap .....	10242	16	<b>4-Cyl. 1.8 L</b>		
2010-2009: Oil Filler Cap .....	10134		2006: OE Type Radiator Cap .....	10249	22
<b>TSX</b>			2006: OE Equivalent Fuel Cap .....	10827	
<b>4-Cyl. 2.4 L</b>			2006: Regular Locking Fuel Cap .....	10597	
2011: OE Type Radiator Cap .....	10242	16	2006: Oil Filler Cap .....	10079	
2011: OE Equivalent Fuel Cap .....	10837		2005: OE Type Radiator Cap .....	10249	22
2011: Regular Locking Fuel Cap .....	10507		2005: OE Equivalent Fuel Cap .....	10827	
2010-2006: OE Type Radiator Cap .....	10242	16	2005: Regular Locking Fuel Cap .....	10597	
2010-2006: OE Equivalent Fuel Cap .....	10837		2005: Oil Filler Cap; W/FWD .....	10130	
2010-2006: Regular Locking Fuel Cap .....	10507		2005: Oil Filler Cap; W/AWD .....	10079	
2010-2006: Oil Filler Cap .....	10134		2004: OE Type Radiator Cap .....	10249	22
2005-2004: OE Type Radiator Cap .....	10242	16	2004: OE Equivalent Fuel Cap .....	10827	
2005-2004: OE Equivalent Fuel Cap .....	10834		2004: Regular Locking Fuel Cap .....	10597	
2005-2004: Regular Locking Fuel Cap .....	10504		2004: Oil Filler Cap .....	10079	
2005-2004: Oil Filler Cap .....	10134		2003-1997: OE Type Radiator Cap .....	10249	22
<b>V-6 3.5 L</b>			2003-1997: OE Equivalent Fuel Cap .....	10835	
2011-2010: OE Type Radiator Cap .....	10242	16	2003-1997: Regular Locking Fuel Cap .....	10505	
2011-2010: OE Equivalent Fuel Cap .....	10837		2003-1997: Oil Filler Cap .....	10079	
2011-2010: Regular Locking Fuel Cap .....	10507		<b>4-Cyl. 2.0 L</b>		
<b>ZDX</b>			2011: OE Type Radiator Cap .....	10249	22
<b>V-6 3.7 L</b>			2010: OE Type Radiator Cap .....	10249	22
2010: OE Type Radiator Cap .....	10242	16	2010: OE Equivalent Fuel Cap; W/Threaded Filler Neck .....	10827	
2010: Oil Filler Cap .....	10134		2010: Regular Locking Fuel Cap; W/Threaded Filler Neck .....	10597	
			2010: OE Equivalent Fuel Cap; W/O Threaded Filler Neck .....	10810	
			2010: Regular Locking Fuel Cap; W/O Threaded Filler Neck .....	10582	

✓ Check Hood Clearance prior to installing this Cap.

## Caps for Passenger Cars and Light Trucks (1990 and Newer)

Application	Part Number	PSI	Application	Part Number	PSI
<b>Audi - Continued</b>			<b>Audi - Continued</b>		
<b>A4 - Continued</b>			<b>A6 - Continued</b>		
<b>4-Cyl. 2.0 L - Continued</b>			<b>V-6 2.7 L - Continued</b>		
2009; OE Type Radiator Cap .....	10249	22	2002-2000; Oil Filler Cap .....	10079	
2009; OE Equivalent Fuel Cap .....	10810		<b>V-6 2.8 L</b>		
2009; Regular Locking Fuel Cap .....	10582		2001-1998; OE Type Radiator Cap .....	10249	22
2008-2006; OE Type Radiator Cap .....	10249	22	2001-1998; OE Equivalent Fuel Cap .....	10835	
2008-2006; OE Equivalent Fuel Cap .....	10827		2001-1998; Regular Locking Fuel Cap .....	10505	
2008-2006; Regular Locking Fuel Cap .....	10597		2001-1998; Oil Filler Cap .....	10079	
2008-2006; Oil Filler Cap .....	10079		1997-1995; OE Type Radiator Cap .....	10225	20
2005; OE Type Radiator Cap; W/AWD .....	10249	22	1997-1995; OE Equivalent Fuel Cap .....	10835	
2005; OE Equivalent Fuel Cap .....	10827		1997-1995; Regular Locking Fuel Cap .....	10505	
2005; Regular Locking Fuel Cap .....	10597		1997-1995; Oil Filler Cap .....	10079	
2005; Oil Filler Cap .....	10079		<b>V-6 3.0 L</b>		
<b>V-6 2.8 L</b>			2011; OE Type Radiator Cap .....	10249	22
2001-1997; OE Type Radiator Cap .....	10249	22	2010-2009; OE Type Radiator Cap .....	10249	22
2001-1997; OE Equivalent Fuel Cap .....	10835		2010-2009; OE Equivalent Fuel Cap .....	10827	
2001-1997; Regular Locking Fuel Cap .....	10505		2010-2009; Regular Locking Fuel Cap .....	10597	
2001-1997; Oil Filler Cap .....	10079		2004; OE Type Radiator Cap .....	10249	22
1996; OE Type Radiator Cap; Early .....	10225	20	2004; OE Equivalent Fuel Cap; OE Has Tether .....	10834	
1996; OE Type Radiator Cap; Late .....	10249	22	2004; Regular Locking Fuel Cap; OE Has Tether .....	10504	
1996; OE Equivalent Fuel Cap .....	10835		2004; OE Equivalent Fuel Cap; No OE Tether .....	10835	
1996; Regular Locking Fuel Cap .....	10505		2004; Regular Locking Fuel Cap; No OE Tether .....	10505	
1996; Oil Filler Cap .....	10079		2004; Oil Filler Cap .....	10079	
<b>V-6 3.0 L</b>			2003; OE Type Radiator Cap .....	10249	22
2006; OE Type Radiator Cap .....	10249	22	2003; OE Equivalent Fuel Cap; Sedan; No OE Tether .....	10835	
2006; OE Equivalent Fuel Cap .....	10827		2003; Regular Locking Fuel Cap; Sedan; No OE Tether .....	10505	
2006; Regular Locking Fuel Cap .....	10597		2003; OE Equivalent Fuel Cap; Sedan; OE Has Tether .....	10834	
2006; Oil Filler Cap .....	10079		2003; Regular Locking Fuel Cap; Sedan; OE Has Tether .....	10504	
2005; OE Type Radiator Cap .....	10249	22	2003; OE Equivalent Fuel Cap; Wagon .....	10834	
2005; OE Equivalent Fuel Cap .....	10827		2003; Regular Locking Fuel Cap; Wagon .....	10504	
2005; Regular Locking Fuel Cap .....	10597		2003; Oil Filler Cap .....	10079	
2005; Oil Filler Cap; W/AWD .....	10079		2002; OE Type Radiator Cap .....	10249	22
2005; Oil Filler Cap; W/FWD .....	10130		2002; OE Equivalent Fuel Cap; Sedan .....	10835	
2004; OE Type Radiator Cap .....	10249	22	2002; Regular Locking Fuel Cap; Sedan .....	10505	
2004; OE Equivalent Fuel Cap .....	10827		2002; OE Equivalent Fuel Cap; Wagon .....	10834	
2004; Regular Locking Fuel Cap .....	10597		2002; Regular Locking Fuel Cap; Wagon .....	10504	
2004; Oil Filler Cap .....	10079		2002; Oil Filler Cap .....	10079	
2003-2002; OE Type Radiator Cap .....	10249	22	<b>V-6 3.2 L</b>		
2003-2002; OE Equivalent Fuel Cap .....	10835		2011; OE Type Radiator Cap .....	10249	22
2003-2002; Regular Locking Fuel Cap .....	10505		2010-2009; OE Type Radiator Cap .....	10249	22
2003-2002; Oil Filler Cap .....	10079		2010-2009; OE Equivalent Fuel Cap .....	10827	
<b>V-6 3.2 L</b>			2010-2009; Regular Locking Fuel Cap .....	10597	
2009; OE Type Radiator Cap .....	10249	22	2010-2009; Regular Locking Fuel Cap .....	10597	
2009; OE Equivalent Fuel Cap .....	10827		2008-2005; OE Type Radiator Cap .....	10249	22
2009; Regular Locking Fuel Cap .....	10582		2008-2005; OE Equivalent Fuel Cap .....	10827	
2009; Oil Filler Cap .....	10079		2008-2005; Regular Locking Fuel Cap .....	10597	
2008-2005; OE Type Radiator Cap .....	10249	22	2008-2005; Oil Filler Cap .....	10079	
2008-2005; OE Equivalent Fuel Cap .....	10827		<b>V-8 4.2 L</b>		
2008-2005; Regular Locking Fuel Cap .....	10597		2011; OE Type Radiator Cap .....	10249	22
2008-2005; Oil Filler Cap .....	10079		2010-2009; OE Type Radiator Cap .....	10249	22
<b>A5</b>			2010-2009; OE Equivalent Fuel Cap .....	10827	
<b>4-Cyl. 2.0 L</b>			2010-2009; Regular Locking Fuel Cap .....	10597	
2011; OE Type Radiator Cap .....	10249	22	2008-2005; OE Type Radiator Cap .....	10249	22
<b>V-6 3.2 L</b>			2008-2005; OE Equivalent Fuel Cap .....	10827	
2010-2009; OE Type Radiator Cap .....	10249	22	2008-2005; Regular Locking Fuel Cap .....	10597	
2010-2009; OE Equivalent Fuel Cap .....	10810		2008-2005; Oil Filler Cap .....	10079	
2010-2009; Regular Locking Fuel Cap .....	10582		2004-2003; OE Type Radiator Cap .....	10249	22
2008; OE Type Radiator Cap .....	10249	22	2004-2003; OE Equivalent Fuel Cap; OE Has Tether .....	10834	
2008; OE Equivalent Fuel Cap .....	10810		2004-2003; Regular Locking Fuel Cap; OE Has Tether .....	10504	
2008; Regular Locking Fuel Cap .....	10582		2004-2003; OE Equivalent Fuel Cap; No OE Tether .....	10835	
2008; Oil Filler Cap .....	10079		2004-2003; Regular Locking Fuel Cap; No OE Tether .....	10505	
<b>A6</b>			2004-2003; Oil Filler Cap .....	10079	
<b>V-6 2.7 L</b>			2002-2000; OE Type Radiator Cap .....	10249	22
2004-2003; OE Type Radiator Cap .....	10249	22	2002-2000; OE Equivalent Fuel Cap .....	10835	
2004-2003; OE Equivalent Fuel Cap; No OE Tether .....	10835		2002-2000; Regular Locking Fuel Cap .....	10505	
2004-2003; Regular Locking Fuel Cap; No OE Tether .....	10505		2002-2000; Oil Filler Cap .....	10079	
2004-2003; OE Equivalent Fuel Cap; OE Has Tether .....	10834		<b>A8</b>		
2004-2003; Regular Locking Fuel Cap; OE Has Tether .....	10504		<b>V-8 3.7 L</b>		
2004-2003; Oil Filler Cap .....	10079		1999-1997; OE Type Radiator Cap .....	10225	20
2002-2000; OE Type Radiator Cap .....	10249	22	1999-1997; OE Equivalent Fuel Cap .....	10835	
2002-2000; OE Equivalent Fuel Cap .....	10835		1999-1997; Regular Locking Fuel Cap .....	10505	
2002-2000; Regular Locking Fuel Cap .....	10505		1999-1997; Oil Filler Cap .....	10079	

## Caps for Passenger Cars and Light Trucks (1990 and Newer)

Application	Part Number	PSI	Application	Part Number	PSI
<b>Audi - Continued</b>			<b>Audi - Continued</b>		
<b>A8 - Continued</b>			<b>Q7 - Continued</b>		
<b>V-8 4.2 L</b>			<b>V-8 4.2 L - Continued</b>		
2010-2009: OE Type Radiator Cap .....	10249	22	2008-2007: Oil Filler Cap .....	10079	
2010-2009: OE Equivalent Fuel Cap .....	10835		<b>R8</b>		
2010-2009: Regular Locking Fuel Cap .....	10505		<b>V-10 5.2 L</b>		
2008-2006: OE Type Radiator Cap .....	10249	22	2011: OE Type Radiator Cap .....	10249	22
2008-2006: OE Equivalent Fuel Cap .....	10835		2010: OE Equivalent Fuel Cap .....	10835	
2008-2006: Regular Locking Fuel Cap .....	10505		2010: Regular Locking Fuel Cap .....	10505	
2008-2006: Oil Filler Cap .....	10079		<b>V-8 4.2 L</b>		
2005: OE Type Radiator Cap .....	10249	22	2011: OE Type Radiator Cap .....	10249	22
2005: OE Equivalent Fuel Cap .....	10827		2010-2009: OE Equivalent Fuel Cap .....	10835	
2005: Regular Locking Fuel Cap .....	10597		2010-2009: Regular Locking Fuel Cap .....	10505	
2005: Oil Filler Cap .....	10079		2008: OE Type Radiator Cap .....	10249	22
2004: OE Type Radiator Cap .....	10249	22	2008: OE Equivalent Fuel Cap .....	10835	
2004: OE Equivalent Fuel Cap .....	10834		2008: Regular Locking Fuel Cap .....	10505	
2004: Regular Locking Fuel Cap .....	10504		2008: Oil Filler Cap .....	10079	
2004: Oil Filler Cap .....	10079		<b>RS4</b>		
2003-1997: OE Type Radiator Cap .....	10225	20	<b>V-8 4.2 L</b>		
2003-1997: OE Equivalent Fuel Cap .....	10835		2008-2007: OE Type Radiator Cap .....	10249	22
2003-1997: Regular Locking Fuel Cap .....	10505		2008-2007: OE Equivalent Fuel Cap .....	10827	
2003-1997: Oil Filler Cap .....	10079		2008-2007: Regular Locking Fuel Cap .....	10597	
<b>W-12 6.0 L</b>			2008-2007: Oil Filler Cap .....	10079	
2009-2006: OE Type Radiator Cap .....	10249	22	<b>RS 6</b>		
2009-2006: OE Equivalent Fuel Cap .....	10835		<b>V-8 4.2 L</b>		
2009-2006: Regular Locking Fuel Cap .....	10505		2003: OE Type Radiator Cap .....	10249	22
2009-2006: Oil Filler Cap .....	10079		2003: OE Equivalent Fuel Cap .....	10834	
2005: OE Type Radiator Cap .....	10249	22	2003: Regular Locking Fuel Cap .....	10504	
2005: OE Equivalent Fuel Cap .....	10834		2003: Oil Filler Cap .....	10079	
2005: Regular Locking Fuel Cap .....	10504		<b>V-8 4.2 L (Canada)</b>		
2005: Oil Filler Cap .....	10079		2004: OE Type Radiator Cap .....	10249	22
<b>Allroad Quattro</b>			2004: OE Equivalent Fuel Cap .....	10834	
<b>V-6 2.7 L</b>			2004: Regular Locking Fuel Cap .....	10504	
2005-2003: OE Type Radiator Cap .....	10249	22	2004: Oil Filler Cap .....	10079	
2005-2003: OE Equivalent Fuel Cap .....	10834		<b>S4</b>		
2005-2003: Regular Locking Fuel Cap .....	10504		<b>V-6 2.7 L</b>		
2005-2003: Oil Filler Cap .....	10079		2002-2000: OE Type Radiator Cap .....	10249	22
2002-2001: OE Type Radiator Cap .....	10249	22	2002-2000: OE Equivalent Fuel Cap .....	10835	
2002-2001: OE Equivalent Fuel Cap .....	10835		2002-2000: Regular Locking Fuel Cap .....	10505	
2002-2001: Regular Locking Fuel Cap .....	10505		2002-2000: Oil Filler Cap .....	10079	
2002-2001: Oil Filler Cap .....	10079		<b>V-6 3.0 L</b>		
<b>V-8 4.2 L</b>			2011: OE Type Radiator Cap .....	10249	22
2005-2003: OE Type Radiator Cap .....	10249	22	2010: OE Equivalent Fuel Cap .....	10810	
2005-2003: OE Equivalent Fuel Cap .....	10834		2010: Regular Locking Fuel Cap .....	10582	
2005-2003: Regular Locking Fuel Cap .....	10504		<b>V-8 4.2 L</b>		
2005-2003: Oil Filler Cap .....	10079		2009: OE Type Radiator Cap .....	10249	22
<b>Cabriolet</b>			2009: OE Equivalent Fuel Cap .....	10827	
<b>V-6 2.8 L</b>			2009: Regular Locking Fuel Cap .....	10597	
1998-1995: OE Type Radiator Cap .....	10225	20	2008-2004: OE Type Radiator Cap .....	10249	22
1998-1995: OE Equivalent Fuel Cap .....	10835		2008-2004: OE Equivalent Fuel Cap .....	10827	
1998-1995: Regular Locking Fuel Cap .....	10505		2008-2004: Regular Locking Fuel Cap .....	10597	
1998-1995: Oil Filler Cap .....	10079		2008-2004: Oil Filler Cap .....	10079	
<b>Q5</b>			<b>S5</b>		
<b>4-Cyl. 2.0 L</b>			<b>V-6 3.0 L</b>		
2011: OE Type Radiator Cap .....	10249	22	2011: OE Type Radiator Cap .....	10249	22
<b>V-6 3.2 L</b>			2010: OE Equivalent Fuel Cap .....	10810	
2011-2009: OE Type Radiator Cap .....	10249	22	2010: Regular Locking Fuel Cap .....	10582	
<b>Q7</b>			<b>V-8 4.2 L</b>		
<b>V-6 3.0 L; V-6 3.0 L Diesel</b>			2011: OE Type Radiator Cap .....	10249	22
2011: OE Type Radiator Cap .....	10249	22	2010-2008: OE Type Radiator Cap .....	10249	22
<b>V-6 3.6 L</b>			2010-2008: OE Equivalent Fuel Cap .....	10810	
2010-2008: OE Type Radiator Cap .....	10249	22	2010-2008: Regular Locking Fuel Cap .....	10582	
2010-2008: Oil Filler Cap .....	10079		<b>S6</b>		
2007: OE Type Radiator Cap .....	10249	22	<b>5-Cyl. 2.2 L</b>		
2007: OE Equivalent Fuel Cap .....	10826		1995: OE Type Radiator Cap .....	10225	20
2007: Regular Locking Fuel Cap .....	10596		1995: OE Equivalent Fuel Cap .....	10835	
2007: Oil Filler Cap .....	10079		1995: Regular Locking Fuel Cap .....	10505	
<b>V-8 4.2 L</b>			1995: Oil Filler Cap .....	10079	
2010: OE Type Radiator Cap .....	10249	22			
2008-2007: OE Type Radiator Cap .....	10249	22			

## Caps for Passenger Cars and Light Trucks (1990 and Newer)

Application	Part Number	PSI	Application	Part Number	PSI
<b>Audi - Continued</b>			<b>Bentley</b>		
<b>S6 - Continued</b>			<b>Arnage</b>		
5-Cyl. 2.2 L (Canada)			V-8 4.4 L		
1996; OE Type Radiator Cap .....	10225	20	2001-1999; OE Equivalent Fuel Cap .....	10825	
1996; OE Equivalent Fuel Cap .....	10835		2001-1999; Regular Locking Fuel Cap .....	10595	
1996; Regular Locking Fuel Cap .....	10505		V-8 6.7 L		
1996; Oil Filler Cap .....	10079		2005-2000; OE Equivalent Fuel Cap .....	10825	
V-10 5.2 L			2005-2000; Regular Locking Fuel Cap .....	10595	
2011; OE Type Radiator Cap .....	10249	22	<b>BMW</b>		
2010-2009; OE Type Radiator Cap .....	10249	22	<b>128i</b>		
2010-2009; OE Equivalent Fuel Cap .....	10827		6-Cyl. 3.0 L		
2010-2009; Regular Locking Fuel Cap .....	10597		2011-2008; OE Equivalent Fuel Cap .....	10844	
2008-2007; OE Type Radiator Cap .....	10249	22	2011-2008; Oil Filler Cap .....	10099	
2008-2007; OE Equivalent Fuel Cap .....	10827		<b>135i</b>		
2008-2007; Regular Locking Fuel Cap .....	10597		6-Cyl. 3.0 L		
2008-2007; Oil Filler Cap .....	10079		2011; OE Equivalent Fuel Cap .....	10844	
V-8 4.2 L			2010-2008; OE Equivalent Fuel Cap .....	10844	
2003; OE Type Radiator Cap .....	10249	22	2010-2008; Oil Filler Cap .....	10099	
2003; OE Equivalent Fuel Cap; No OE Tether .....	10835		<b>318i</b>		
2003; Regular Locking Fuel Cap; No OE Tether .....	10505		4-Cyl. 1.8 L		
2003; OE Equivalent Fuel Cap; OE Has Tether .....	10834		1995; OE Type Radiator Cap .....	10247	30
2003; Regular Locking Fuel Cap; OE Has Tether .....	10504		1995; OE Equivalent Fuel Cap .....	10810	
2003; Oil Filler Cap .....	10079		1995; Oil Filler Cap .....	10079	
2002; OE Type Radiator Cap .....	10249	22	4-Cyl. 1.9 L		
2002; OE Equivalent Fuel Cap; OE Has Tether .....	10835		1998-1997; OE Type Radiator Cap .....	10247	30
2002; Regular Locking Fuel Cap; OE Has Tether .....	10505		1998-1997; OE Equivalent Fuel Cap .....	10843	
2002; OE Equivalent Fuel Cap; No OE Tether .....	10834		1998-1997; Oil Filler Cap .....	10131	
2002; Regular Locking Fuel Cap; No OE Tether .....	10504		1996; OE Type Radiator Cap .....	10247	30
2002; Oil Filler Cap .....	10079		1996; OE Equivalent Fuel Cap .....	10810	
<b>S8</b>			1996; Oil Filler Cap .....	10079	
V-10 5.2 L			4-Cyl. 1.9 L (Canada)		
2009-2007; OE Type Radiator Cap .....	10249	22	1999; OE Type Radiator Cap .....	10247	30
2009-2007; OE Equivalent Fuel Cap .....	10835		1999; OE Equivalent Fuel Cap .....	10843	
2009-2007; Regular Locking Fuel Cap .....	10505		1999; Oil Filler Cap .....	10131	
2009-2007; Oil Filler Cap .....	10079		<b>318IS</b>		
V-8 4.2 L			4-Cyl. 1.8 L		
2003-2001; OE Type Radiator Cap .....	10225	20	1995; OE Type Radiator Cap .....	10247	30
2003-2001; OE Equivalent Fuel Cap .....	10835		1995; OE Equivalent Fuel Cap .....	10810	
2003-2001; Regular Locking Fuel Cap .....	10505		1995; Oil Filler Cap .....	10079	
2003-2001; Oil Filler Cap .....	10079		4-Cyl. 1.9 L		
<b>TT</b>			1997; OE Type Radiator Cap .....	10247	30
4-Cyl. 1.8 L			1997; OE Equivalent Fuel Cap .....	10843	
2006; OE Type Radiator Cap .....	10249	22	1997; Oil Filler Cap .....	10079	
2006; OE Equivalent Fuel Cap .....	10835		1996; OE Type Radiator Cap .....	10247	30
2006; Regular Locking Fuel Cap .....	10505		1996; OE Equivalent Fuel Cap .....	10810	
2006; Oil Filler Cap .....	10079		1996; Oil Filler Cap .....	10079	
2005; OE Type Radiator Cap .....	10249	22	4-Cyl. 1.9 L (Canada)		
2005; OE Equivalent Fuel Cap; W/AWD .....	10835		1999-1998; OE Type Radiator Cap .....	10247	30
2005; Regular Locking Fuel Cap; W/AWD .....	10505		1999-1998; OE Equivalent Fuel Cap .....	10843	
2005; OE Equivalent Fuel Cap; W/FWD .....	10827		1999-1998; Oil Filler Cap .....	10131	
2005; Regular Locking Fuel Cap; W/FWD .....	10597		<b>318Ti</b>		
2005; Oil Filler Cap .....	10079		4-Cyl. 1.8 L		
2004-2000; OE Type Radiator Cap .....	10249	22	1995; OE Type Radiator Cap .....	10247	30
2004-2000; OE Equivalent Fuel Cap .....	10835		1995; OE Equivalent Fuel Cap .....	10810	
2004-2000; Regular Locking Fuel Cap .....	10505		1995; Oil Filler Cap .....	10079	
2004-2000; Oil Filler Cap .....	10079		4-Cyl. 1.9 L		
4-Cyl. 2.0 L			1999; OE Type Radiator Cap .....	10247	30
2011; OE Type Radiator Cap .....	10249	22	1999; OE Equivalent Fuel Cap .....	10843	
2010-2008; OE Type Radiator Cap .....	10249	22	1999; Oil Filler Cap .....	10079	
2010-2008; Oil Filler Cap .....	10079		1998-1997; OE Type Radiator Cap .....	10247	30
V-6 3.2 L			1998-1997; OE Equivalent Fuel Cap .....	10843	
2009; OE Type Radiator Cap .....	10249	22	1998-1997; Oil Filler Cap .....	10131	
2009; Oil Filler Cap .....	10079		1996; OE Type Radiator Cap .....	10247	30
2008; OE Type Radiator Cap .....	10249	22	1996; OE Equivalent Fuel Cap .....	10810	
2008; OE Equivalent Fuel Cap .....	10835		1996; Oil Filler Cap .....	10079	
2008; Regular Locking Fuel Cap .....	10505		4-Cyl. 1.9 L (Canada)		
2008; Oil Filler Cap .....	10079		1999-1998; OE Type Radiator Cap .....	10247	30
2006-2004; OE Type Radiator Cap .....	10249	22	1999-1998; OE Equivalent Fuel Cap .....	10843	
2006-2004; OE Equivalent Fuel Cap .....	10835		1999-1998; Oil Filler Cap .....	10131	
2006-2004; Regular Locking Fuel Cap .....	10505		<b>318Ti</b>		
2006-2004; Oil Filler Cap .....	10079		4-Cyl. 1.8 L		



## Caps for Passenger Cars and Light Trucks (1990 and Newer)

Application	Part Number	PSI	Application	Part Number	PSI
<b>BMW - Continued</b>			<b>BMW - Continued</b>		
<b>323CI</b>			<b>328CI - Continued</b>		
6-Cyl. 2.5 L			6-Cyl. 2.8 L - Continued		
2000: OE Type Radiator Cap .....	10247	30	2000: Oil Filler Cap .....	10079	
2000: OE Equivalent Fuel Cap .....	10844		<b>328I</b>		
2000: Oil Filler Cap .....	10131		6-Cyl. 2.8 L		
<b>323I</b>			2000: OE Type Radiator Cap .....		
6-Cyl. 2.5 L			2000: OE Equivalent Fuel Cap .....		
2000: OE Type Radiator Cap .....	10247	30	2000: Oil Filler Cap .....		
2000: OE Equivalent Fuel Cap .....	10844		1999: OE Type Radiator Cap .....		
2000: Oil Filler Cap .....	10079		1999: OE Equivalent Fuel Cap; Aug. & Older .....		
1999: OE Type Radiator Cap .....	10247	30	1999: OE Equivalent Fuel Cap; Sept. 1 & Newer .....		
1999: OE Equivalent Fuel Cap; Aug. & Older .....	10843		1999: Oil Filler Cap .....		
1999: OE Equivalent Fuel Cap; Sept. 1 & Newer .....	10844		1998: OE Type Radiator Cap .....		
1999: Oil Filler Cap .....	10079		1998: OE Equivalent Fuel Cap .....		
1998: OE Type Radiator Cap .....	10247	30	1998: Oil Filler Cap .....		
1998: OE Equivalent Fuel Cap .....	10843		1997: OE Type Radiator Cap .....		
1998: Oil Filler Cap .....	10131		1997: OE Equivalent Fuel Cap .....		
<b>323IS</b>			1997: Oil Filler Cap .....		
6-Cyl. 2.5 L			1996: OE Type Radiator Cap .....		
1999: OE Type Radiator Cap .....	10247	30	1996: OE Equivalent Fuel Cap .....		
1999: OE Equivalent Fuel Cap .....	10843		1996: Oil Filler Cap .....		
1999: Oil Filler Cap .....	10079		6-Cyl. 3.0 L		
1998: OE Type Radiator Cap .....	10247	30	2011-2008: OE Equivalent Fuel Cap .....		
1998: OE Equivalent Fuel Cap .....	10843		2011-2008: Oil Filler Cap .....		
1998: Oil Filler Cap .....	10131		2007: OE Equivalent Fuel Cap .....		
<b>323TI</b>			2007: Oil Filler Cap .....		
6-Cyl. 2.5 L (Non-US)			<b>328IS</b>		
2000-1999: OE Type Radiator Cap .....	10247	30	6-Cyl. 2.8 L		
<b>325CI</b>			1999: OE Type Radiator Cap .....		
6-Cyl. 2.5 L			1999: OE Equivalent Fuel Cap .....		
2006-2005: OE Type Radiator Cap .....	10247	30	1999: Oil Filler Cap .....		
2006-2005: OE Equivalent Fuel Cap .....	10844		1998: OE Type Radiator Cap .....		
2006-2005: Oil Filler Cap .....	10131		1998: OE Equivalent Fuel Cap .....		
2004-2001: OE Type Radiator Cap .....	10247	30	1998: Oil Filler Cap .....		
2004-2001: OE Equivalent Fuel Cap .....	10844		1997: OE Type Radiator Cap .....		
2004-2001: Oil Filler Cap .....	10079		1997: OE Equivalent Fuel Cap .....		
<b>325I</b>			1997: Oil Filler Cap .....		
6-Cyl. 2.5 L			1996: OE Type Radiator Cap .....		
2005-2001: OE Type Radiator Cap .....	10247	30	1996: OE Equivalent Fuel Cap .....		
2005-2001: OE Equivalent Fuel Cap .....	10844		1996: Oil Filler Cap .....		
2005-2001: Oil Filler Cap .....	10079		<b>328XI</b>		
1995: OE Type Radiator Cap .....	10247	30	6-Cyl. 3.0 L		
1995: OE Equivalent Fuel Cap .....	10810		2008: OE Equivalent Fuel Cap .....		
1995: Oil Filler Cap .....	10079		2008: Oil Filler Cap .....		
6-Cyl. 3.0 L			2007: OE Equivalent Fuel Cap .....		
2006: OE Equivalent Fuel Cap .....	10844		2007: Oil Filler Cap .....		
2006: Oil Filler Cap .....	10131		<b>330CI</b>		
<b>325IS</b>			6-Cyl. 3.0 L		
6-Cyl. 2.5 L			2006: OE Type Radiator Cap .....		
1995: OE Type Radiator Cap .....	10247	30	2006: Oil Filler Cap .....		
1995: OE Equivalent Fuel Cap .....	10810		2005: OE Type Radiator Cap .....		
1995: Oil Filler Cap .....	10079		2005: OE Equivalent Fuel Cap .....		
<b>325XI</b>			2005: Oil Filler Cap .....		
6-Cyl. 2.5 L			2004-2001: OE Type Radiator Cap .....		
2005: OE Type Radiator Cap .....	10247	30	2004-2001: OE Equivalent Fuel Cap .....		
2005: OE Equivalent Fuel Cap .....	10844		2004-2001: Oil Filler Cap .....		
2005: Oil Filler Cap .....	10131		<b>330I; 330XI</b>		
2004-2001: OE Type Radiator Cap .....	10247	30	6-Cyl. 3.0 L		
2004-2001: OE Equivalent Fuel Cap .....	10844		2006: OE Equivalent Fuel Cap .....		
2004-2001: Oil Filler Cap .....	10079		2006: Oil Filler Cap .....		
6-Cyl. 3.0 L			2005: OE Type Radiator Cap .....		
2006: OE Equivalent Fuel Cap .....	10844		2005: OE Equivalent Fuel Cap .....		
2006: Oil Filler Cap .....	10131		2005: Oil Filler Cap .....		
<b>328CI</b>			2004-2001: OE Type Radiator Cap .....		
6-Cyl. 2.8 L			2004-2001: OE Equivalent Fuel Cap .....		
2000: OE Type Radiator Cap .....	10247	30	2004-2001: Oil Filler Cap .....		
2000: OE Equivalent Fuel Cap .....	10844		<b>335D</b>		
<b>328CI</b>			6-Cyl. 3.0 L Diesel		
6-Cyl. 2.8 L			2010-2009: Oil Filler Cap .....		
2000: OE Type Radiator Cap .....	10247	30			
2000: OE Equivalent Fuel Cap .....	10844				

## Caps for Passenger Cars and Light Trucks (1990 and Newer)

Application	Part Number	PSI	Application	Part Number	PSI
<b>BMW - Continued</b>			<b>BMW - Continued</b>		
<b>335I</b>			<b>530XI</b>		
6-Cyl. 3.0 L			6-Cyl. 3.0 L		
2011-2008; OE Equivalent Fuel Cap .....	10844		2007-2006; OE Equivalent Fuel Cap .....	10844	
2011-2008; Oil Filler Cap .....	10099		2007-2006; Oil Filler Cap .....	10131	
2007; OE Equivalent Fuel Cap .....	10844				
2007; Oil Filler Cap .....	10131				
<b>335XI</b>			<b>535I</b>		
6-Cyl. 3.0 L			6-Cyl. 3.0 L		
2008; OE Equivalent Fuel Cap .....	10844		2011; OE Equivalent Fuel Cap .....	10844	
2008; Oil Filler Cap .....	10099		2010-2008; OE Equivalent Fuel Cap .....	10844	
2007; OE Equivalent Fuel Cap .....	10844		2010-2008; Oil Filler Cap .....	10099	
2007; Oil Filler Cap .....	10131				
<b>525I</b>			<b>535XI</b>		
6-Cyl. 2.5 L			6-Cyl. 3.0 L		
2005; OE Equivalent Fuel Cap .....	10844		2008; OE Equivalent Fuel Cap .....	10844	
2005; Oil Filler Cap .....	10131		2008; Oil Filler Cap .....	10099	
2004; OE Equivalent Fuel Cap .....	10844		2007; OE Equivalent Fuel Cap .....	10844	
2004; Oil Filler Cap .....	10079		2007; Oil Filler Cap .....	10131	
2003-2002; OE Type Radiator Cap .....	10247	30			
2003-2002; OE Equivalent Fuel Cap .....	10844				
2003-2002; Oil Filler Cap .....	10079				
2001; OE Type Radiator Cap .....	10247	30			
2001; OE Equivalent Fuel Cap .....	10844				
2001; Oil Filler Cap .....	10131				
1995; OE Type Radiator Cap .....	10247	30			
1995; OE Equivalent Fuel Cap .....	10810				
1995; Oil Filler Cap .....	10079				
6-Cyl. 3.0 L			6-Cyl. 3.0 L		
2007-2006; OE Equivalent Fuel Cap .....	10844		2008; OE Equivalent Fuel Cap .....	10844	
2007-2006; Oil Filler Cap .....	10131		2008; Oil Filler Cap .....	10099	
<b>525XI</b>			<b>540I</b>		
6-Cyl. 3.0 L			V-8 4.0 L		
2007-2006; OE Equivalent Fuel Cap .....	10844		1995; OE Type Radiator Cap .....	10247	30
2007-2006; Oil Filler Cap .....	10131		1995; OE Equivalent Fuel Cap .....	10810	
			1995; Oil Filler Cap .....	10079	
<b>528I</b>			V-8 4.4 L		
6-Cyl. 2.8 L			2003-2001; OE Type Radiator Cap .....		
2000; OE Type Radiator Cap .....	10247	30	2003-2001; OE Equivalent Fuel Cap .....	10844	
2000; OE Equivalent Fuel Cap .....	10844		2003-2001; Oil Filler Cap .....	10079	
2000; Oil Filler Cap .....	10131		2000; OE Type Radiator Cap .....	10247	30
1999; OE Type Radiator Cap .....	10247	30	2000; OE Equivalent Fuel Cap .....	10844	
1999; OE Equivalent Fuel Cap; Aug. & Older .....	10843		2000; Oil Filler Cap .....	10131	
1999; OE Equivalent Fuel Cap; Sept. 1 & Newer .....	10844		1999; OE Type Radiator Cap .....	10247	30
1999; Oil Filler Cap .....	10079		1999; OE Equivalent Fuel Cap; Aug. & Older .....	10843	
1998-1997; OE Type Radiator Cap .....	10247	30	1999; OE Equivalent Fuel Cap; Sept. 1 & Newer .....	10844	
1998-1997; OE Equivalent Fuel Cap .....	10810		1999; Oil Filler Cap .....	10131	
1998-1997; Regular Locking Fuel Cap .....	10582		1998; OE Type Radiator Cap .....	10247	30
1998-1997; Oil Filler Cap .....	10079		1998; OE Equivalent Fuel Cap .....	10810	
6-Cyl. 3.0 L			1998; Regular Locking Fuel Cap .....		
2011-2008; OE Equivalent Fuel Cap .....	10844		1997; OE Type Radiator Cap .....	10247	30
2011-2008; Oil Filler Cap .....	10099		1997; OE Equivalent Fuel Cap .....	10810	
			1997; Regular Locking Fuel Cap .....	10582	
<b>528XI</b>			1997; Oil Filler Cap .....		
6-Cyl. 3.0 L			<b>545I</b>		
2008; OE Equivalent Fuel Cap .....	10844		V-8 4.4 L		
2008; Oil Filler Cap .....	10099		2005; OE Equivalent Fuel Cap .....		
			2005; Oil Filler Cap .....		
<b>530I</b>			2004; OE Type Radiator Cap .....		
6-Cyl. 3.0 L			2004; OE Equivalent Fuel Cap .....		
2007-2005; OE Equivalent Fuel Cap .....	10844		2004; Oil Filler Cap .....		
2007-2005; Oil Filler Cap .....	10131				
2004-2002; OE Type Radiator Cap .....	10247	30	<b>550I</b>		
2004-2002; OE Equivalent Fuel Cap .....	10844		V-8 4.4 L		
2004-2002; Oil Filler Cap .....	10079		2011; OE Equivalent Fuel Cap .....		
2001; OE Type Radiator Cap .....	10247	30	2010; OE Equivalent Fuel Cap .....		
2001; OE Equivalent Fuel Cap .....	10844		2010; Oil Filler Cap .....		
2001; Oil Filler Cap .....	10131				
V-8 3.0 L			V-8 4.8 L		
1995; OE Type Radiator Cap .....	10247	30	2010-2006; OE Equivalent Fuel Cap .....		
1995; OE Equivalent Fuel Cap .....	10810		2010-2006; Oil Filler Cap .....		
1995; Oil Filler Cap .....	10079				
			<b>645CI</b>		
			V-8 4.4 L		
			2005; OE Equivalent Fuel Cap .....		
			2005; Oil Filler Cap .....		
			2004; OE Equivalent Fuel Cap .....		
			2004; Oil Filler Cap .....		
			<b>650I</b>		
			V-8 4.8 L		
			2010-2006; OE Equivalent Fuel Cap .....		
			2010-2006; Oil Filler Cap .....		
			<b>740I</b>		
			6-Cyl. 3.0 L		
			2011; OE Equivalent Fuel Cap .....		
			2011; Oil Filler Cap .....		

## Caps for Passenger Cars and Light Trucks (1990 and Newer)

Application	Part Number	PSI	Application	Part Number	PSI
<b>BMW - Continued</b>			<b>BMW - Continued</b>		
<b>740I - Continued</b>			<b>750I</b>		
<b>V-8 4.0 L</b>			<b>V-8 4.4 L</b>		
1995: OE Type Radiator Cap .....	10247	30	2011: OE Equivalent Fuel Cap .....	10844	
1995: OE Equivalent Fuel Cap .....	10810		2010-2009: OE Equivalent Fuel Cap .....	10844	
1995: Oil Filler Cap .....	10079		2010-2009: Oil Filler Cap .....	10131	
<b>V-8 4.4 L</b>			<b>V-8 4.4 L Electric Assist</b>		
2001: OE Type Radiator Cap .....	10247	30	2011: OE Equivalent Fuel Cap .....	10844	
2001: OE Equivalent Fuel Cap .....	10843		<b>V-8 4.8 L</b>		
2001: Oil Filler Cap .....	10079		2008-2006: OE Type Radiator Cap .....	10247	30
2000: OE Type Radiator Cap .....	10247	30	2008-2006: OE Equivalent Fuel Cap .....	10844	
2000: OE Equivalent Fuel Cap .....	10843		2008-2006: Oil Filler Cap .....	10131	
2000: Oil Filler Cap .....	10131		<b>750IL</b>		
1999: OE Type Radiator Cap .....	10247	30	<b>V-12 5.4 L</b>		
1999: OE Equivalent Fuel Cap; Aug. & Older .....	10843		2001-2000: OE Type Radiator Cap .....	10247	30
1999: OE Equivalent Fuel Cap; Sept. 1 & Newer .....	10844		2001-2000: OE Equivalent Fuel Cap .....	10843	
1999: Oil Filler Cap .....	10079		2001-2000: Oil Filler Cap .....	10079	
1998: OE Type Radiator Cap .....	10247	30	1999: OE Type Radiator Cap .....	10247	30
1998: OE Equivalent Fuel Cap .....	10843		1999: OE Equivalent Fuel Cap; Aug. & Older .....	10843	
1998: Oil Filler Cap .....	10079		1999: OE Equivalent Fuel Cap; Sept. 1 & Newer .....	10844	
1997: OE Type Radiator Cap .....	10247	30	1999: Oil Filler Cap .....	10079	
1997: OE Equivalent Fuel Cap .....	10843		1998: OE Type Radiator Cap .....	10247	30
1997: Oil Filler Cap .....	10131		1998: OE Equivalent Fuel Cap .....	10843	
<b>740IL</b>			1998: Oil Filler Cap .....	10131	
<b>V-8 4.0 L</b>			1997: OE Type Radiator Cap .....	10247	30
1995: OE Type Radiator Cap .....	10247	30	1997: OE Equivalent Fuel Cap .....	10843	
1995: OE Equivalent Fuel Cap .....	10810		1997: Oil Filler Cap .....	10079	
1995: Oil Filler Cap .....	10079		1996-1995: OE Type Radiator Cap .....	10247	30
<b>V-8 4.4 L</b>			1996-1995: OE Equivalent Fuel Cap .....	10810	
2001: OE Type Radiator Cap .....	10247	30	1996-1995: Oil Filler Cap .....	10079	
2001: OE Equivalent Fuel Cap .....	10843		<b>750LI</b>		
2001: Oil Filler Cap .....	10079		<b>V-8 4.4 L</b>		
2000: OE Type Radiator Cap .....	10247	30	2011: OE Equivalent Fuel Cap .....	10844	
2000: OE Equivalent Fuel Cap .....	10843		2010-2009: OE Equivalent Fuel Cap .....	10844	
2000: Oil Filler Cap .....	10131		2010-2009: Oil Filler Cap .....	10131	
1999: OE Type Radiator Cap .....	10247	30	<b>V-8 4.4 L Electric Assist</b>		
1999: OE Equivalent Fuel Cap; Aug. & Older .....	10843		2011: OE Equivalent Fuel Cap .....	10844	
1999: OE Equivalent Fuel Cap; Sept. 1 & Newer .....	10844		<b>V-8 4.8 L</b>		
1999: Oil Filler Cap .....	10079		2008-2006: OE Type Radiator Cap .....	10247	30
1998: OE Type Radiator Cap .....	10247	30	2008-2006: OE Equivalent Fuel Cap .....	10844	
1998: OE Equivalent Fuel Cap .....	10843		2008-2006: Oil Filler Cap .....	10131	
1998: Oil Filler Cap .....	10079		<b>760I</b>		
1997: OE Type Radiator Cap .....	10247	30	<b>V-12 6.0 L</b>		
1997: OE Equivalent Fuel Cap .....	10843		2006-2005: OE Type Radiator Cap .....	10247	30
1997: Oil Filler Cap .....	10131		2006-2005: OE Equivalent Fuel Cap .....	10844	
1996: OE Type Radiator Cap .....	10247	30	2006-2005: Oil Filler Cap .....	10131	
1996: OE Equivalent Fuel Cap .....	10810		2004: OE Type Radiator Cap .....	10247	30
1996: Oil Filler Cap .....	10079		2004: OE Equivalent Fuel Cap .....	10844	
<b>740LI</b>			2004: Oil Filler Cap .....	10079	
<b>6-Cyl. 3.0 L</b>			<b>760LI</b>		
2011: OE Equivalent Fuel Cap .....	10844		<b>V-12 6.0 L</b>		
<b>745I</b>			2011: OE Equivalent Fuel Cap .....	10844	
<b>V-8 4.4 L</b>			2010: OE Equivalent Fuel Cap .....	10844	
2005: OE Type Radiator Cap .....	10247	30	2010: Oil Filler Cap .....	10099	
2005: OE Equivalent Fuel Cap .....	10844		2008-2005: OE Type Radiator Cap .....	10247	30
2005: Oil Filler Cap .....	10131		2008-2005: OE Equivalent Fuel Cap .....	10844	
2004-2002: OE Type Radiator Cap .....	10247	30	2008-2005: Oil Filler Cap .....	10131	
2004-2002: OE Equivalent Fuel Cap .....	10844		2004: OE Type Radiator Cap .....	10247	30
2004-2002: Oil Filler Cap .....	10079		2004: OE Equivalent Fuel Cap .....	10844	
<b>745LI</b>			2004: Oil Filler Cap .....	10079	
<b>V-8 4.4 L</b>			2003: OE Type Radiator Cap .....	10247	30
2005: OE Type Radiator Cap .....	10247	30	2003: Oil Filler Cap .....	10079	
2005: OE Equivalent Fuel Cap .....	10844		<b>840CI</b>		
2005: Oil Filler Cap .....	10131		<b>V-8 4.0 L</b>		
2004-2003: OE Type Radiator Cap .....	10247	30	1995: OE Type Radiator Cap .....	10247	30
2004-2003: OE Equivalent Fuel Cap .....	10844		1995: OE Equivalent Fuel Cap .....	10810	
2004-2003: Oil Filler Cap .....	10079		1995: Oil Filler Cap .....	10079	
2002: OE Type Radiator Cap .....	10247	30	<b>V-8 4.4 L</b>		
2002: OE Equivalent Fuel Cap .....	10843		1997: OE Type Radiator Cap .....	10247	30
2002: Oil Filler Cap .....	10079		1997: OE Equivalent Fuel Cap .....	10843	

## Caps for Passenger Cars and Light Trucks (1990 and Newer)

Application	Part Number	PSI	Application	Part Number	PSI
<b>BMW - Continued</b>			<b>BMW - Continued</b>		
<b>840CI - Continued</b>			<b>X3 - Continued</b>		
<b>V-8 4.4 L - Continued</b>			<b>6-Cyl. 2.5 L - Continued</b>		
1997: Oil Filler Cap .....	10079		2004: OE Type Radiator Cap .....	10247	30
1996: OE Type Radiator Cap .....	10247	30	2004: OE Equivalent Fuel Cap .....	10844	
1996: OE Equivalent Fuel Cap .....	10810		2004: Oil Filler Cap .....	10079	
1996: Oil Filler Cap .....	10079		<b>6-Cyl. 2.5 L (Canada)</b>		
<b>850CI</b>			2006: OE Type Radiator Cap .....		
<b>V-12 5.4 L</b>			2006: OE Equivalent Fuel Cap .....		
1997: OE Type Radiator Cap .....	10247	30	2006: Oil Filler Cap .....	10131	30
1997: OE Equivalent Fuel Cap .....	10843		<b>6-Cyl. 3.0 L</b>		
1997: Oil Filler Cap .....	10079		2011: OE Equivalent Fuel Cap .....		
1996-1995: OE Type Radiator Cap .....	10247	30	2010: OE Type Radiator Cap .....		
1996-1995: OE Equivalent Fuel Cap .....	10810		2010: OE Equivalent Fuel Cap .....		
1996-1995: Oil Filler Cap .....	10079		2010: Oil Filler Cap .....		
<b>V-12 5.4 L (Non-US)</b>			2009: OE Type Radiator Cap .....		
1998: OE Type Radiator Cap .....	10247	30	2009: OE Equivalent Fuel Cap .....		
<b>850CSI</b>			2009: Oil Filler Cap .....		
<b>V-12 5.6 L</b>			2008: OE Type Radiator Cap .....		
1995: OE Type Radiator Cap .....	10247	30	2008: OE Equivalent Fuel Cap .....		
1995: OE Equivalent Fuel Cap .....	10810		2008: Oil Filler Cap .....		
1995: Oil Filler Cap .....	10079		2007-2005: OE Type Radiator Cap .....		
<b>Alpina B7</b>			2007-2005: OE Equivalent Fuel Cap .....		
<b>V-8 4.4 L</b>			2007-2005: Oil Filler Cap .....		
2011: OE Equivalent Fuel Cap .....	10844		2004: OE Type Radiator Cap .....		
2008: OE Type Radiator Cap .....	10247	30	2004: OE Equivalent Fuel Cap .....		
2008: Oil Filler Cap .....	10131		2004: Oil Filler Cap .....		
2007: OE Type Radiator Cap .....	10247	30	<b>X5</b>		
<b>M3</b>			<b>6-Cyl. 3.0 L</b>		
<b>6-Cyl. 3.0 L</b>			2011: OE Equivalent Fuel Cap .....		
1995: OE Type Radiator Cap .....	10247	30	2010-2009: OE Equivalent Fuel Cap .....		
1995: OE Equivalent Fuel Cap .....	10810		2010-2009: Oil Filler Cap .....		
1995: Oil Filler Cap .....	10079		2008-2007: OE Equivalent Fuel Cap .....		
<b>6-Cyl. 3.2 L</b>			2008-2007: Oil Filler Cap .....		
2006-2001: OE Type Radiator Cap .....	10247	30	2006-2005: OE Type Radiator Cap .....		
2006-2001: OE Equivalent Fuel Cap .....	10844		2006-2005: OE Equivalent Fuel Cap .....		
1999-1997: OE Type Radiator Cap .....	10247	30	2006-2005: Oil Filler Cap .....		
1999-1997: OE Equivalent Fuel Cap .....	10843		2004-2001: OE Type Radiator Cap .....		
1999-1997: Oil Filler Cap .....	10079		2004-2001: OE Equivalent Fuel Cap .....		
1996: OE Type Radiator Cap .....	10247	30	2004-2001: Oil Filler Cap .....		
1996: OE Equivalent Fuel Cap .....	10810		<b>6-Cyl. 3.0 L Diesel</b>		
1996: Oil Filler Cap .....	10079		2010: OE Equivalent Fuel Cap .....		
<b>V-8 4.0 L</b>			2010: Oil Filler Cap .....		
2011-2008: OE Equivalent Fuel Cap .....	10844		2009: OE Equivalent Fuel Cap .....		
<b>M5</b>			<b>V-8 4.4 L</b>		
<b>V-10 5.0 L</b>			2011-2010: OE Equivalent Fuel Cap .....		
2010-2009: OE Equivalent Fuel Cap .....	10844		2006-2005: OE Type Radiator Cap .....		
2008: OE Type Radiator Cap .....	10233	16	2006-2005: OE Equivalent Fuel Cap .....		
2008: OE Equivalent Fuel Cap .....	10844		2006-2005: Oil Filler Cap .....		
2007-2006: OE Equivalent Fuel Cap .....	10844		2004-2001: OE Type Radiator Cap .....		
<b>V-8 5.0 L</b>			2004-2001: OE Equivalent Fuel Cap .....		
2003-2001: OE Type Radiator Cap .....	10247	30	2004-2001: Oil Filler Cap .....		
2003-2001: OE Equivalent Fuel Cap .....	10844		2000: OE Type Radiator Cap .....		
2003-2001: Oil Filler Cap .....	10079		2000: OE Equivalent Fuel Cap .....		
2000: OE Type Radiator Cap .....	10247	30	2000: Oil Filler Cap .....		
2000: OE Equivalent Fuel Cap .....	10843		<b>V-8 4.6 L</b>		
2000: Oil Filler Cap .....	10131		2003-2002: OE Type Radiator Cap .....		
<b>M6</b>			2003-2002: OE Equivalent Fuel Cap .....		
<b>V-10 5.0 L</b>			2003-2002: Oil Filler Cap .....		
2010-2009: OE Equivalent Fuel Cap .....	10844		<b>V-8 4.8 L</b>		
2008: OE Type Radiator Cap .....	10233	16	2010-2007: OE Equivalent Fuel Cap .....		
2008: OE Equivalent Fuel Cap .....	10844		2010-2007: Oil Filler Cap .....		
2007-2006: OE Equivalent Fuel Cap .....	10844		2006-2004: OE Type Radiator Cap .....		
<b>X3</b>			2006-2004: OE Equivalent Fuel Cap .....		
<b>6-Cyl. 2.5 L</b>			2006-2004: Oil Filler Cap .....		
2005: OE Type Radiator Cap .....	10247	30	<b>X6</b>		
2005: OE Equivalent Fuel Cap .....	10844		<b>6-Cyl. 3.0 L</b>		
2005: Oil Filler Cap .....	10131		2011: OE Equivalent Fuel Cap .....		
			2010: OE Equivalent Fuel Cap .....		
			2010: Oil Filler Cap .....		
			2009-2008: Oil Filler Cap .....		

## Caps for Passenger Cars and Light Trucks (1990 and Newer)

Application	Part Number	PSI	Application	Part Number	PSI
<b>BMW - Continued</b>			<b>BMW - Continued</b>		
<b>X6 - Continued</b>			<b>Z8</b>		
<b>V-8 4.4 L</b>			<b>V-8 5.0 L</b>		
2011: OE Equivalent Fuel Cap .....	10844		2003-2000: OE Type Radiator Cap .....	10247	30
2010: OE Equivalent Fuel Cap .....	10844		2003-2000: OE Equivalent Fuel Cap .....	10843	
2010: Oil Filler Cap .....	10131		2003-2000: Oil Filler Cap .....	10079	
2009-2008: Oil Filler Cap .....	10131				
<b>V-8 4.4 L Electric Assist</b>			<b>Buick</b>		
2010: OE Equivalent Fuel Cap .....	10844		<b>Allure</b>		
2010: Oil Filler Cap .....	10131		<b>V-6 3.6 L (Canada); V-6 3.8 L (Canada)</b>		
<b>Z3</b>			2008-2005: OE Type Radiator Cap .....		
<b>4-Cyl. 1.9 L</b>			2008-2005: OE Equivalent Fuel Cap .....		
1998: OE Type Radiator Cap .....	10247	30	2008-2005: Regular Locking Fuel Cap .....		
1998: Oil Filler Cap .....	10079		2008-2005: Oil Filler Cap .....		
1997: OE Type Radiator Cap .....	10247	30	2008-2005: OE Type Radiator Cap .....		
1997: Oil Filler Cap .....	10131		2008-2005: OE Equivalent Fuel Cap .....		
1996: OE Type Radiator Cap .....	10247	30	2008-2005: Regular Locking Fuel Cap .....		
1996: Oil Filler Cap .....	10079		2008-2005: Oil Filler Cap .....		
<b>6-Cyl. 2.5 L</b>			<b>V-8 5.3 L (Canada)</b>		
2002-2001: OE Type Radiator Cap .....	10247	30	2008: OE Type Radiator Cap .....		
2002-2001: OE Equivalent Fuel Cap .....	10843		2008: OE Equivalent Fuel Cap .....		
2002-2001: Oil Filler Cap .....	10079		2008: Regular Locking Fuel Cap .....		
2000-1999: OE Type Radiator Cap .....	10247	30	2008: Oil Filler Cap .....		
2000-1999: OE Equivalent Fuel Cap .....	10843		<b>Century</b>		
2000-1999: Oil Filler Cap .....	10131		<b>4-Cyl. 2.2 L</b>		
<b>6-Cyl. 2.8 L</b>			1996-1995: Lev-R-Vent Radiator Cap .....		
2000: OE Type Radiator Cap .....	10247	30	1996-1995: OE Type Radiator Cap .....		
2000: OE Equivalent Fuel Cap .....	10843		1996-1995: OE Equivalent Fuel Cap .....		
2000: Oil Filler Cap .....	10131		1996-1995: Pre-Vent Non-Locking Fuel Cap .....		
1999: OE Type Radiator Cap .....	10247	30	1996-1995: Regular Locking Fuel Cap .....		
1999: OE Equivalent Fuel Cap; Aug. & Older .....	10843		1996-1995: Pre-Vent Locking Fuel Cap .....		
1999: OE Equivalent Fuel Cap; Sept. 1 & Newer .....	10844		1996-1995: Oil Filler Cap .....		
1999: Oil Filler Cap .....	10079		<b>V-6 3.1 L</b>		
1998-1997: OE Type Radiator Cap .....	10247	30	2005-1997: Lev-R-Vent Radiator Cap .....		
1998-1997: Oil Filler Cap .....	10131		2005-1997: OE Type Radiator Cap .....		
<b>6-Cyl. 3.0 L</b>			2005-1997: OE Equivalent Fuel Cap .....		
2002-2001: OE Type Radiator Cap .....	10247	30	2005-1997: Regular Locking Fuel Cap .....		
2002-2001: OE Equivalent Fuel Cap .....	10843		2005-1997: Oil Filler Cap .....		
2002-2001: Oil Filler Cap .....	10079		1996-1995: Lev-R-Vent Radiator Cap .....		
<b>6-Cyl. 3.2 L</b>			1996-1995: OE Type Radiator Cap .....		
2002-2000: OE Type Radiator Cap .....	10247	30	1996-1995: OE Equivalent Fuel Cap .....		
2002-2000: OE Equivalent Fuel Cap .....	10843		1996-1995: Pre-Vent Non-Locking Fuel Cap .....		
2002-2000: Oil Filler Cap .....	10079		1996-1995: Regular Locking Fuel Cap .....		
1999: OE Type Radiator Cap .....	10247	30	1996-1995: Pre-Vent Locking Fuel Cap .....		
1999: OE Equivalent Fuel Cap; Aug. & Older .....	10843		1996-1995: Oil Filler Cap .....		
1999: OE Equivalent Fuel Cap; Sept. 1 & Newer .....	10844		<b>Enclave</b>		
1999: Oil Filler Cap .....	10079		<b>V-6 3.6 L</b>		
1998: OE Type Radiator Cap .....	10247	30	2011: OE Type Radiator Cap .....		
1998: Oil Filler Cap .....	10079		2011: OE Equivalent Fuel Cap .....		
<b>Z4</b>			2011: Regular Locking Fuel Cap .....		
<b>6-Cyl. 2.5 L</b>			2010-2008: OE Type Radiator Cap .....		
2005: OE Type Radiator Cap .....	10247	30	2010-2008: OE Equivalent Fuel Cap .....		
2005: OE Equivalent Fuel Cap .....	10844		2010-2008: Regular Locking Fuel Cap .....		
2005: Oil Filler Cap .....	10131		2010-2008: Oil Filler Cap .....		
2004-2003: OE Type Radiator Cap .....	10247	30	<b>LaCrosse</b>		
2004-2003: OE Equivalent Fuel Cap .....	10844		<b>4-Cyl. 2.4 L</b>		
2004-2003: Oil Filler Cap .....	10079		2011: OE Equivalent Fuel Cap .....		
<b>6-Cyl. 3.0 L</b>			2011: Regular Locking Fuel Cap .....		
2011: OE Equivalent Fuel Cap .....	10844		2010: Oil Filler Cap .....		
2010: OE Equivalent Fuel Cap .....	10844		<b>V-6 3.0 L</b>		
2010: Oil Filler Cap .....	10099		2010: OE Equivalent Fuel Cap .....		
2009: OE Type Radiator Cap .....	10247	30	2010: Regular Locking Fuel Cap .....		
2009: OE Equivalent Fuel Cap .....	10844		<b>V-6 3.6 L</b>		
2008-2005: OE Type Radiator Cap .....	10247	30	2011: OE Equivalent Fuel Cap .....		
2008-2005: OE Equivalent Fuel Cap .....	10844		2011: Regular Locking Fuel Cap .....		
2008-2005: Oil Filler Cap .....	10131		2010: OE Equivalent Fuel Cap .....		
2004-2003: OE Type Radiator Cap .....	10247	30	2010: Regular Locking Fuel Cap .....		
2004-2003: OE Equivalent Fuel Cap .....	10844		2010: Oil Filler Cap .....		
2004-2003: Oil Filler Cap .....	10079		2008-2005: OE Type Radiator Cap .....		
<b>6-Cyl. 3.2 L</b>			2008-2005: OE Equivalent Fuel Cap .....		
2008-2006: OE Type Radiator Cap .....	10247	30	2008-2005: Regular Locking Fuel Cap .....		
2008-2006: OE Equivalent Fuel Cap .....	10844				

## Caps for Passenger Cars and Light Trucks (1990 and Newer)

Application	Part Number	PSI	Application	Part Number	PSI
<b>Buick - Continued</b>			<b>Buick - Continued</b>		
<b>LaCrosse - Continued</b>			<b>Park Avenue - Continued</b>		
<b>V-6 3.6 L - Continued</b>			<b>V-6 3.8 L - Continued</b>		
2008-2005; Oil Filler Cap .....	10099		1995; Coolant Recovery Tank Cap .....	10236	
<b>V-6 3.8 L</b>			1995; OE Equivalent Fuel Cap .....	10817	
2009-2008; OE Equivalent Fuel Cap .....	10841		1995; Pre-Vent Non-Locking Fuel Cap .....	10819	
2009-2008; Regular Locking Fuel Cap .....	10511		1995; Regular Locking Fuel Cap .....	10591	
2009-2008; Oil Filler Cap .....	10099		1995; Pre-Vent Locking Fuel Cap .....	10501	
2007-2005; OE Type Radiator Cap .....	10248	15	1995; Oil Filler Cap .....	10099	
2007-2005; OE Equivalent Fuel Cap .....	10841		<b>Rainier</b>		
2007-2005; Regular Locking Fuel Cap .....	10511		<b>6-Cyl. 4.2 L; V-8 5.3 L</b>		
2007-2005; Oil Filler Cap .....	10099		2007-2005; OE Type Radiator Cap .....	10248	15
<b>V-8 5.3 L</b>			2007-2005; OE Equivalent Fuel Cap .....	10841	
2009-2008; OE Equivalent Fuel Cap .....	10841		2007-2005; Regular Locking Fuel Cap .....	10511	
2009-2008; Regular Locking Fuel Cap .....	10511		2007-2005; Oil Filler Cap .....	10099	
2009-2008; Oil Filler Cap .....	10099		2004; OE Type Radiator Cap .....	10248	15
<b>Lesabre</b>			2004; OE Equivalent Fuel Cap .....	10836	
<b>V-6 3.8 L</b>			2004; Regular Locking Fuel Cap .....	10506	
2005-1998; Lev-R-Vent Radiator Cap .....	10331	16	2004; Oil Filler Cap .....	10099	
2005-1998; OE Type Radiator Cap .....	10231	16	<b>Regal</b>		
2005-1998; OE Equivalent Fuel Cap .....	10836		<b>4-Cyl. 2.0 L</b>		
2005-1998; Regular Locking Fuel Cap .....	10506		2011; OE Equivalent Fuel Cap .....	10834	
2005-1998; Oil Filler Cap .....	10099		2011; Flex Fuel Regular Fuel Cap .....	10834Y	
1997-1996; Lev-R-Vent Radiator Cap .....	10331	16	2011; Regular Locking Fuel Cap .....	10504	
1997-1996; OE Type Radiator Cap .....	10231	16	2011; Flex Fuel Regular Locking Fuel Cap .....	10504Y	
1997-1996; OE Equivalent Fuel Cap .....	10834		<b>4-Cyl. 2.4 L</b>		
1997-1996; Regular Locking Fuel Cap .....	10504		2011; OE Equivalent Fuel Cap; 1st Design .....	10841	
1997-1996; Oil Filler Cap .....	10099		2011; Regular Locking Fuel Cap; 1st Design .....	10511	
1995; Lev-R-Vent Radiator Cap .....	10331	16	2011; OE Equivalent Fuel Cap; 2nd Design .....	10834	
1995; OE Type Radiator Cap .....	10231	16	2011; Regular Locking Fuel Cap; 2nd Design .....	10504	
1995; Coolant Recovery Tank Cap .....	10236		<b>V-6 3.1 L</b>		
1995; OE Equivalent Fuel Cap .....	10817		1996-1995; Lev-R-Vent Radiator Cap .....	10331	16
1995; Pre-Vent Non-Locking Fuel Cap .....	10819		1996-1995; OE Type Radiator Cap .....	10231	16
1995; Regular Locking Fuel Cap .....	10591		1996-1995; OE Equivalent Fuel Cap .....	10817	
1995; Pre-Vent Locking Fuel Cap .....	10501		1996-1995; Pre-Vent Non-Locking Fuel Cap .....	10819	
1995; Oil Filler Cap .....	10099		1996-1995; Regular Locking Fuel Cap .....	10591	
<b>Lucerne</b>			1996-1995; Pre-Vent Locking Fuel Cap .....	10501	
<b>V-6 3.8 L</b>			1996-1995; Oil Filler Cap .....	10099	
2008-2006; OE Type Radiator Cap .....	10248	15	<b>V-6 3.8 L</b>		
2008-2006; OE Equivalent Fuel Cap .....	10841		2004-1997; Lev-R-Vent Radiator Cap .....	10331	16
2008-2006; Regular Locking Fuel Cap .....	10523		2004-1997; OE Type Radiator Cap .....	10231	16
2008-2006; Oil Filler Cap .....	10099		2004-1997; OE Equivalent Fuel Cap .....	10836	
<b>V-6 3.9 L</b>			2004-1997; Regular Locking Fuel Cap .....	10506	
2011-2010; OE Type Radiator Cap .....	10248	15	2004-1997; Oil Filler Cap .....	10099	
2011-2010; OE Equivalent Fuel Cap .....	10841		1996-1995; Lev-R-Vent Radiator Cap .....	10331	16
2011-2010; Flex Fuel Regular Fuel Cap .....	10841Y		1996-1995; OE Type Radiator Cap .....	10231	16
2011-2010; Regular Locking Fuel Cap .....	10523		1996-1995; OE Equivalent Fuel Cap .....	10817	
2011-2010; Oil Filler Cap .....	10099		1996-1995; Pre-Vent Non-Locking Fuel Cap .....	10819	
2009; OE Type Radiator Cap .....	10248	15	1996-1995; Regular Locking Fuel Cap .....	10591	
2009; OE Equivalent Fuel Cap .....	10841		1996-1995; Pre-Vent Locking Fuel Cap .....	10501	
2009; Regular Locking Fuel Cap .....	10523		1996-1995; Oil Filler Cap .....	10099	
2009; Oil Filler Cap .....	10099		<b>Rendezvous</b>		
<b>V-8 4.6 L</b>			<b>V-6 3.4 L</b>		
2011-2006; OE Equivalent Fuel Cap .....	10841		2005-2002; Lev-R-Vent Radiator Cap .....	10331	16
2011-2006; Regular Locking Fuel Cap .....	10523		2005-2002; OE Type Radiator Cap .....	10231	16
2011-2006; Oil Filler Cap .....	10099		2005-2002; OE Equivalent Fuel Cap .....	10836	
<b>Park Avenue</b>			2005-2002; Regular Locking Fuel Cap .....	10506	
<b>V-6 3.8 L</b>			2005-2002; Oil Filler Cap .....	10099	
2005-1998; Lev-R-Vent Radiator Cap .....	10331	16	<b>V-6 3.5 L</b>		
2005-1998; OE Type Radiator Cap .....	10231	16	2007-2006; Lev-R-Vent Radiator Cap .....	10331	16
2005-1998; OE Equivalent Fuel Cap .....	10836		2007-2006; OE Type Radiator Cap .....	10231	16
2005-1998; Regular Locking Fuel Cap .....	10506		2007-2006; OE Equivalent Fuel Cap .....	10841	
2005-1998; Oil Filler Cap .....	10099		2007-2006; Regular Locking Fuel Cap .....	10511	
1997-1996; Lev-R-Vent Radiator Cap .....	10331	16	2007-2006; Oil Filler Cap .....	10099	
1997-1996; OE Type Radiator Cap .....	10231	16	<b>V-6 3.6 L</b>		
1997-1996; OE Equivalent Fuel Cap .....	10817		2006-2004; Lev-R-Vent Radiator Cap .....	10331	16
1997-1996; Pre-Vent Non-Locking Fuel Cap .....	10819		2006-2004; OE Type Radiator Cap .....	10231	16
1997-1996; Regular Locking Fuel Cap .....	10591		2006-2004; OE Equivalent Fuel Cap .....	10841	
1997-1996; Pre-Vent Locking Fuel Cap .....	10501		2006-2004; Regular Locking Fuel Cap .....	10511	
1997-1996; Oil Filler Cap .....	10099		2006-2004; Oil Filler Cap .....	10099	
1995; Lev-R-Vent Radiator Cap .....	10331	16			
1995; OE Type Radiator Cap .....	10231	16			

## Caps for Passenger Cars and Light Trucks (1990 and Newer)

Application	Part Number	PSI	Application	Part Number	PSI
<b>Buick - Continued</b>			<b>Cadillac</b>		
<b>Riviera</b>			<b>Catera</b>		
<b>V-6 3.8 L</b>			<b>V-6 3.0 L</b>		
1999-1998; Lev-R-Vent Radiator Cap .....	10331	16	2001-1999; OE Type Radiator Cap .....	10261	20
1999-1998; OE Type Radiator Cap .....	10231	16	2001-1999; OE Equivalent Fuel Cap .....	10847	
1999-1998; OE Equivalent Fuel Cap .....	10836		2001-1999; Regular Locking Fuel Cap .....	10517	
1999-1998; Regular Locking Fuel Cap .....	10506		2001-1999; Oil Filler Cap .....	10140	
1999-1998; Oil Filler Cap .....	10099		1998-1997; OE Type Radiator Cap .....	10261	20
1997-1995; Lev-R-Vent Radiator Cap .....	10331	16	1998-1997; OE Equivalent Fuel Cap .....	10826	
1997-1995; OE Type Radiator Cap .....	10231	16	1998-1997; Regular Locking Fuel Cap .....	10596	
1997-1995; OE Equivalent Fuel Cap .....	10817		1998-1997; Oil Filler Cap .....	10140	
1997-1995; Pre-Vent Non-Locking Fuel Cap .....	10819				
1997-1995; Regular Locking Fuel Cap .....	10591		<b>CTS</b>		
1997-1995; Pre-Vent Locking Fuel Cap .....	10501		<b>V-6 2.8 L</b>		
1997-1995; Oil Filler Cap .....	10099		2007; OE Type Radiator Cap .....	10248	15
<b>Roadmaster</b>			2007; OE Equivalent Fuel Cap .....	10841	
<b>V-8 5.7 L</b>			2007; Regular Locking Fuel Cap .....	10511	
1996-1995; OE Type Radiator Cap .....	10239	15	2007; Oil Filler Cap .....	10099	
1996-1995; OE Equivalent Fuel Cap .....	10817		2006-2005; OE Type Radiator Cap .....	10248	15
1996-1995; Pre-Vent Non-Locking Fuel Cap .....	10819		2006-2005; OE Equivalent Fuel Cap .....	10848	
1996-1995; Regular Locking Fuel Cap .....	10591		2006-2005; Regular Locking Fuel Cap .....	10518	
1996-1995; Pre-Vent Locking Fuel Cap .....	10501		2006-2005; Oil Filler Cap .....	10099	
1996-1995; Oil Filler Cap .....	10105		<b>V-6 3.0 L</b>		
<b>Skylark</b>			2011-2010; OE Type Radiator Cap .....	10248	15
<b>4-Cyl. 2.3 L</b>			2011-2010; OE Equivalent Fuel Cap .....	10841	
1995; OE Type Radiator Cap .....	10239	15	2011-2010; Regular Locking Fuel Cap .....	10511	
1995; OE Equivalent Fuel Cap .....	10817		2011-2010; Oil Filler Cap .....	10099	
1995; Pre-Vent Non-Locking Fuel Cap .....	10819		<b>V-6 3.2 L</b>		
1995; Regular Locking Fuel Cap .....	10591		2004-2003; OE Type Radiator Cap .....	10248	15
1995; Pre-Vent Locking Fuel Cap .....	10501		2004-2003; OE Equivalent Fuel Cap .....	10836	
1995; Oil Filler Cap .....	10132		2004-2003; Regular Locking Fuel Cap .....	10506	
<b>4-Cyl. 2.4 L</b>			2004-2003; Oil Filler Cap .....	10140	
1998-1997; OE Type Radiator Cap .....	10239	15	<b>V-6 3.6 L</b>		
1998-1997; OE Equivalent Fuel Cap .....	10836		2011-2007; OE Type Radiator Cap .....	10248	15
1998-1997; Regular Locking Fuel Cap .....	10506		2011-2007; OE Equivalent Fuel Cap .....	10841	
1998-1997; Oil Filler Cap .....	10105		2011-2007; Regular Locking Fuel Cap .....	10511	
1996; OE Type Radiator Cap .....	10239	15	2011-2007; Oil Filler Cap .....	10099	
1996; OE Equivalent Fuel Cap .....	10834		2006-2005; OE Type Radiator Cap .....	10248	15
1996; Regular Locking Fuel Cap .....	10504		2006-2005; OE Equivalent Fuel Cap .....	10848	
1996; Oil Filler Cap .....	10105		2006-2005; Regular Locking Fuel Cap .....	10518	
<b>V-6 3.1 L</b>			2006-2005; Oil Filler Cap .....	10099	
1998-1997; OE Type Radiator Cap .....	10239	15	2004; OE Type Radiator Cap .....	10248	15
1998-1997; OE Equivalent Fuel Cap .....	10836		2004; OE Equivalent Fuel Cap .....	10836	
1998-1997; Regular Locking Fuel Cap .....	10506		2004; Regular Locking Fuel Cap .....	10506	
1998-1997; Oil Filler Cap .....	10099		2004; Oil Filler Cap .....	10099	
1996; OE Type Radiator Cap .....	10239	15	<b>V-8 5.7 L</b>		
1996; OE Equivalent Fuel Cap .....	10834		2005; OE Type Radiator Cap .....	10248	15
1996; Regular Locking Fuel Cap .....	10504		2005; OE Equivalent Fuel Cap .....	10848	
1996; Oil Filler Cap .....	10099		2005; Regular Locking Fuel Cap .....	10518	
1995; OE Type Radiator Cap .....	10239	15	2005; Oil Filler Cap .....	10099	
1995; OE Equivalent Fuel Cap .....	10817		2004; OE Type Radiator Cap .....	10248	15
1995; Pre-Vent Non-Locking Fuel Cap .....	10819		2004; OE Equivalent Fuel Cap .....	10836	
1995; Regular Locking Fuel Cap .....	10591		2004; Regular Locking Fuel Cap .....	10506	
1995; Pre-Vent Locking Fuel Cap .....	10501		2004; Oil Filler Cap .....	10099	
1995; Oil Filler Cap .....	10099		<b>V-8 6.0 L</b>		
<b>Terraza</b>			2007; OE Type Radiator Cap .....	10248	15
<b>V-6 3.5 L</b>			2007; OE Equivalent Fuel Cap .....	10841	
2006; Lev-R-Vent Radiator Cap .....	10331	16	2007; Regular Locking Fuel Cap .....	10511	
2006; OE Type Radiator Cap .....	10231	16	2007; Oil Filler Cap .....	10099	
2006; OE Equivalent Fuel Cap .....	10841		2006; OE Type Radiator Cap .....	10248	15
2006; Regular Locking Fuel Cap .....	10511		2006; OE Equivalent Fuel Cap .....	10848	
2006; Oil Filler Cap .....	10099		2006; Regular Locking Fuel Cap .....	10518	
2005; Lev-R-Vent Radiator Cap .....	10331	16	2006; Oil Filler Cap .....	10099	
2005; OE Type Radiator Cap .....	10231	16	<b>V-8 6.2 L</b>		
2005; Coolant Recovery Tank Cap .....	10236		2011-2009; OE Type Radiator Cap .....	10248	15
2005; OE Equivalent Fuel Cap .....	10841		2011-2009; OE Equivalent Fuel Cap .....	10841	
2005; Regular Locking Fuel Cap .....	10511		2011-2009; Regular Locking Fuel Cap .....	10511	
2005; Oil Filler Cap .....	10099		2011-2009; Oil Filler Cap .....	10099	
<b>V-6 3.9 L</b>			<b>Deville</b>		
2007-2006; OE Equivalent Fuel Cap .....	10841		<b>V-8 4.6 L</b>		
2007-2006; Regular Locking Fuel Cap .....	10511		2005-2001; Lev-R-Vent Radiator Cap .....	10334	18
2007-2006; Oil Filler Cap .....	10099		2005-2001; OE Type Radiator Cap .....	10234	18
			2005-2001; OE Equivalent Fuel Cap .....	10836	

## Caps for Passenger Cars and Light Trucks (1990 and Newer)

Application	Part Number	PSI	Application	Part Number	PSI
<b>Cadillac - Continued</b>			<b>Cadillac - Continued</b>		
<b>Deville - Continued</b>			<b>Escalade - Continued</b>		
<b>V-8 4.6 L - Continued</b>			<b>V-8 6.0 L - Continued</b>		
2005-2001; Regular Locking Fuel Cap .....	10506		2004; Regular Locking Fuel Cap; W/O Threaded Filler Neck .....	10511	
2005-2001; Oil Filler Cap .....	10099		2004; OE Equivalent Fuel Cap; W/Threaded Filler Neck .....	10834	
2000-1998; Lev-R-Vent Radiator Cap .....	10330	16	2004; Regular Locking Fuel Cap; W/Threaded Filler Neck .....	10504	
2000-1998; OE Type Radiator Cap .....	10230	16	2004; Oil Filler Cap .....	10099	
2000-1998; OE Equivalent Fuel Cap .....	10836		2003-2002; OE Type Radiator Cap .....	10248	15
2000-1998; Regular Locking Fuel Cap .....	10506		2003-2002; OE Equivalent Fuel Cap .....	10834	
2000-1998; Oil Filler Cap .....	10099		2003-2002; Regular Locking Fuel Cap .....	10504	
1997-1995; Lev-R-Vent Radiator Cap .....	10330	16	2003-2002; Oil Filler Cap .....	10099	
1997-1995; OE Type Radiator Cap .....	10230	16	<b>V-8 6.0 L Electric Assist</b>		
1997-1995; Pre-Vent Non-Locking Fuel Cap .....	10819		2011; OE Equivalent Fuel Cap .....	10841	
1997-1995; Pre-Vent Locking Fuel Cap .....	10501		2011; Regular Locking Fuel Cap .....	10511	
1997-1995; Oil Filler Cap .....	10099		2011; Oil Filler Cap .....	10099	
<b>V-8 4.9 L</b>			2010-2009; OE Type Radiator Cap .....	10248	15
1995; Lev-R-Vent Radiator Cap .....	10331	16	2010-2009; OE Equivalent Fuel Cap .....	10841	
1995; OE Type Radiator Cap .....	10231	16	2010-2009; Regular Locking Fuel Cap .....	10511	
1995; Pre-Vent Non-Locking Fuel Cap .....	10819		2010-2009; Oil Filler Cap .....	10099	
1995; Pre-Vent Locking Fuel Cap .....	10501		<b>V-8 6.2 L</b>		
1995; Oil Filler Cap .....	10118		2011; OE Equivalent Fuel Cap .....	10841	
<b>DTS</b>			2011; Flex Fuel Regular Fuel Cap .....	10841Y	
<b>V-8 4.6 L</b>			2011; Regular Locking Fuel Cap .....	10511	
2011-2006; OE Equivalent Fuel Cap .....	10841		2011; Flex Fuel Regular Locking Fuel Cap .....	10511Y	
2011-2006; Regular Locking Fuel Cap .....	10511		2011; Oil Filler Cap .....	10099	
2011-2006; Oil Filler Cap .....	10099		2010; OE Type Radiator Cap .....	10248	15
<b>Eldorado</b>			2010; OE Equivalent Fuel Cap .....	10841	
<b>V-8 4.6 L</b>			2010; Flex Fuel Regular Fuel Cap .....	10841Y	
2002-2001; Lev-R-Vent Radiator Cap .....	10334	18	2010; Regular Locking Fuel Cap .....	10511	
2002-2001; OE Type Radiator Cap .....	10234	18	2010; Flex Fuel Regular Locking Fuel Cap .....	10511Y	
2002-2001; OE Equivalent Fuel Cap .....	10836		2010; Oil Filler Cap .....	10099	
2002-2001; Regular Locking Fuel Cap .....	10506		2009-2007; OE Type Radiator Cap .....	10248	15
2002-2001; Oil Filler Cap .....	10099		2009-2007; OE Equivalent Fuel Cap .....	10841	
2000-1998; Lev-R-Vent Radiator Cap .....	10330	16	2009-2007; Regular Locking Fuel Cap .....	10511	
2000-1998; OE Type Radiator Cap .....	10230	16	2009-2007; Oil Filler Cap .....	10099	
2000-1998; OE Equivalent Fuel Cap .....	10836		<b>Fleetwood</b>		
2000-1998; Regular Locking Fuel Cap .....	10506		<b>V-8 5.7 L</b>		
2000-1998; Oil Filler Cap .....	10099		1996-1995; OE Type Radiator Cap .....	10239	15
1997-1995; Lev-R-Vent Radiator Cap .....	10330	16	1996-1995; OE Equivalent Fuel Cap .....	10817	
1997-1995; OE Type Radiator Cap .....	10230	16	1996-1995; Pre-Vent Non-Locking Fuel Cap .....	10819	
1997-1995; Pre-Vent Non-Locking Fuel Cap .....	10819		1996-1995; Regular Locking Fuel Cap .....	10591	
1997-1995; Pre-Vent Locking Fuel Cap .....	10501		1996-1995; Pre-Vent Locking Fuel Cap .....	10501	
1997-1995; Oil Filler Cap .....	10099		1996-1995; Oil Filler Cap .....	10105	
<b>Escalade</b>			<b>Seville</b>		
<b>V-8 5.3 L</b>			<b>V-8 4.6 L</b>		
2005; OE Type Radiator Cap .....	10248	15	2004-2001; OE Type Radiator Cap .....	10257	18
2005; OE Equivalent Fuel Cap .....	10841		2004-2001; OE Equivalent Fuel Cap .....	10836	
2005; Regular Locking Fuel Cap .....	10511		2004-2001; Regular Locking Fuel Cap .....	10506	
2005; Oil Filler Cap .....	10099		2004-2001; Oil Filler Cap .....	10099	
2004; OE Type Radiator Cap .....	10248	15	2000; OE Type Radiator Cap .....	10239	15
2004; OE Equivalent Fuel Cap; W/O Threaded Filler Neck .....	10841		2000; OE Equivalent Fuel Cap .....	10836	
2004; Regular Locking Fuel Cap; W/O Threaded Filler Neck .....	10511		2000; Regular Locking Fuel Cap .....	10506	
2004; OE Equivalent Fuel Cap; W/Threaded Filler Neck .....	10834		2000; Oil Filler Cap .....	10099	
2004; Regular Locking Fuel Cap; W/Threaded Filler Neck .....	10504		1999-1998; Lev-R-Vent Radiator Cap .....	10330	16
2004; Oil Filler Cap .....	10099		1999-1998; OE Type Radiator Cap .....	10230	16
2003-2002; OE Type Radiator Cap .....	10248	15	1999-1998; OE Equivalent Fuel Cap .....	10836	
2003-2002; OE Equivalent Fuel Cap .....	10834		1999-1998; Regular Locking Fuel Cap .....	10506	
2003-2002; Regular Locking Fuel Cap .....	10504		1999-1998; Oil Filler Cap .....	10099	
2003-2002; Oil Filler Cap .....	10099		1997-1995; Lev-R-Vent Radiator Cap .....	10330	16
<b>V-8 5.7 L</b>			1997-1995; OE Type Radiator Cap .....	10230	16
2000-1999; Lev-R-Vent Radiator Cap .....	10331	16	1997-1995; Pre-Vent Non-Locking Fuel Cap .....	10819	
2000-1999; OE Type Radiator Cap .....	10231	16	1997-1995; Pre-Vent Locking Fuel Cap .....	10501	
2000-1999; OE Equivalent Fuel Cap .....	10834		1997-1995; Oil Filler Cap .....	10099	
2000-1999; Regular Locking Fuel Cap .....	10504		<b>SRX</b>		
2000-1999; Oil Filler Cap .....	10105		<b>V-6 2.8 L; V-6 3.0 L</b>		
<b>V-8 6.0 L</b>			2011-2010; OE Equivalent Fuel Cap .....	10834	
2006-2005; OE Type Radiator Cap .....	10248	15	2011-2010; Regular Locking Fuel Cap .....	10504	
2006-2005; OE Equivalent Fuel Cap .....	10841		2011-2010; Oil Filler Cap .....	10099	
2006-2005; Regular Locking Fuel Cap .....	10511		<b>V-6 3.6 L; V-8 4.6 L</b>		
2006-2005; Oil Filler Cap .....	10099		2009-2007; OE Type Radiator Cap .....	10248	15
2004; OE Type Radiator Cap .....	10248	15	2009-2007; OE Equivalent Fuel Cap .....	10841	
2004; OE Equivalent Fuel Cap; W/O Threaded Filler Neck .....	10841		2009-2007; Regular Locking Fuel Cap .....	10511	



## Caps for Passenger Cars and Light Trucks (1990 and Newer)

Application	Part Number	PSI	Application	Part Number	PSI
<b>Cadillac - Continued</b>			<b>Chevrolet</b>		
<b>SRX - Continued</b>			<b>Astro</b>		
<b>V-6 3.6 L; V-8 4.6 L - Continued</b>			<b>V-6 4.3 L</b>		
2009-2007; Oil Filler Cap .....	10099		2005-1997; Lev-R-Vent Radiator Cap .....	10331	16
2006-2005; OE Type Radiator Cap .....	10248	15	2005-1997; OE Type Radiator Cap .....	10231	16
2006-2005; OE Equivalent Fuel Cap .....	10848		2005-1997; OE Equivalent Fuel Cap .....	10836	
2006-2005; Regular Locking Fuel Cap .....	10518		2005-1997; Regular Locking Fuel Cap .....	10506	
2006-2005; Oil Filler Cap .....	10099		2005-1997; Oil Filler Cap .....	10114	
2004; OE Type Radiator Cap .....	10248	15	1996; Lev-R-Vent Radiator Cap .....	10331	16
2004; OE Equivalent Fuel Cap .....	10836		1996; OE Type Radiator Cap .....	10231	16
2004; Regular Locking Fuel Cap .....	10506		1996; OE Equivalent Fuel Cap .....	10817	
2004; Oil Filler Cap .....	10099		1996; Pre-Vent Non-Locking Fuel Cap .....	10819	
<b>STS</b>			1996; Regular Locking Fuel Cap .....	10591	
<b>V-6 3.6 L</b>			1996; Pre-Vent Locking Fuel Cap .....	10501	
2011; OE Equivalent Fuel Cap .....	10841		1996; Oil Filler Cap .....	10114	
2011; Regular Locking Fuel Cap .....	10523		1995; Lev-R-Vent Radiator Cap .....	10331	16
2011; Oil Filler Cap .....	10099		1995; OE Type Radiator Cap .....	10231	16
2010-2007; OE Type Radiator Cap .....	10248	15	1995; OE Equivalent Fuel Cap .....	10817	
2010-2007; OE Equivalent Fuel Cap .....	10841		1995; Pre-Vent Non-Locking Fuel Cap .....	10819	
2010-2007; Regular Locking Fuel Cap .....	10523		1995; Regular Locking Fuel Cap .....	10591	
2010-2007; Oil Filler Cap .....	10099		1995; Pre-Vent Locking Fuel Cap .....	10501	
2006-2005; OE Type Radiator Cap .....	10248	15	1995; Oil Filler Cap .....	10072	
2006-2005; OE Equivalent Fuel Cap .....	10848		<b>Avalanche</b>		
2006-2005; Regular Locking Fuel Cap .....	10523		<b>V-8 5.3 L</b>		
2006-2005; Oil Filler Cap .....	10099		2011; OE Equivalent Fuel Cap .....	10841	
<b>V-8 4.4 L</b>			2011; Flex Fuel Regular Fuel Cap .....	10841Y	
2009; OE Type Radiator Cap .....	10248	15	2011; Regular Locking Fuel Cap .....	10511	
2009; OE Equivalent Fuel Cap .....	10841		2011; Flex Fuel Regular Locking Fuel Cap .....	10511Y	
2009; Regular Locking Fuel Cap .....	10523		2011; Oil Filler Cap .....	10099	
2009; Oil Filler Cap .....	10099		2010; OE Type Radiator Cap .....	10248	15
2008-2007; OE Equivalent Fuel Cap .....	10841		2010; OE Equivalent Fuel Cap .....	10841	
2008-2007; Regular Locking Fuel Cap .....	10523		2010; Flex Fuel Regular Fuel Cap .....	10841Y	
2008-2007; Oil Filler Cap .....	10099		2010; Regular Locking Fuel Cap .....	10511	
2006; OE Equivalent Fuel Cap .....	10848		2010; Flex Fuel Regular Locking Fuel Cap .....	10511Y	
2006; Regular Locking Fuel Cap .....	10523		2010; Oil Filler Cap .....	10099	
2006; Oil Filler Cap .....	10099		2009; OE Type Radiator Cap .....	10248	15
<b>V-8 4.6 L</b>			2009; OE Equivalent Fuel Cap .....	10841	
2010-2009; OE Type Radiator Cap .....	10248	15	2009; Regular Locking Fuel Cap .....	10511	
2010-2009; OE Equivalent Fuel Cap .....	10841		2009; Oil Filler Cap .....	10099	
2010-2009; Regular Locking Fuel Cap .....	10523		2008-2005; OE Type Radiator Cap .....	10248	15
2010-2009; Oil Filler Cap .....	10099		2008-2005; OE Equivalent Fuel Cap .....	10841	
2008; OE Type Radiator Cap .....	10248	15	2008-2005; Flex Fuel Regular Fuel Cap .....	10841Y	
2008; Regular Locking Fuel Cap .....	10523		2008-2005; Regular Locking Fuel Cap .....	10511	
2008; Oil Filler Cap .....	10099		2008-2005; Flex Fuel Regular Locking Fuel Cap .....	10511Y	
2007; OE Type Radiator Cap .....	10248	15	2008-2005; Oil Filler Cap .....	10099	
2007; OE Equivalent Fuel Cap .....	10841		2004; OE Type Radiator Cap .....	10248	15
2007; Regular Locking Fuel Cap .....	10523		2004; OE Equivalent Fuel Cap; W/O Threaded Filler Neck .....	10841	
2007; Oil Filler Cap .....	10099		2004; Flex Fuel Regular Fuel Cap; W/O Threaded Filler Neck ...	10841Y	
2006-2005; OE Type Radiator Cap .....	10248	15	2004; Regular Locking Fuel Cap; W/O Threaded Filler Neck .....	10511	
2006-2005; OE Equivalent Fuel Cap .....	10848		2004; Flex Fuel Regular Locking Fuel Cap; W/O Threaded Filler		
2006-2005; Regular Locking Fuel Cap .....	10523		Neck .....	10511Y	
2006-2005; Oil Filler Cap .....	10099		2004; OE Equivalent Fuel Cap; W/Threaded Filler Neck .....	10834	
<b>XLR</b>			2004; Flex Fuel Regular Fuel Cap; W/Threaded Filler Neck .....	10834Y	
<b>V-8 4.4 L</b>			2004; Regular Locking Fuel Cap; W/Threaded Filler Neck .....	10504	
2009; Oil Filler Cap .....	10099		2004; Flex Fuel Regular Locking Fuel Cap; W/Threaded Filler		
2008-2007; OE Equivalent Fuel Cap .....	10841		Neck .....	10504Y	
2008-2007; Regular Locking Fuel Cap .....	10511		2004; Oil Filler Cap .....	10099	
2008-2007; Oil Filler Cap .....	10099		2003; OE Type Radiator Cap .....	10248	15
2006; OE Equivalent Fuel Cap .....	10848		2003; OE Equivalent Fuel Cap .....	10834	
2006; Regular Locking Fuel Cap .....	10518		2003; Flex Fuel Regular Fuel Cap .....	10834Y	
2006; Oil Filler Cap .....	10099		2003; Regular Locking Fuel Cap .....	10504	
<b>V-8 4.6 L</b>			2003; Flex Fuel Regular Locking Fuel Cap .....	10504Y	
2009; Oil Filler Cap .....	10099		2003; Oil Filler Cap .....	10099	
2008-2007; OE Equivalent Fuel Cap .....	10841		2002; OE Type Radiator Cap .....	10248	15
2008-2007; Regular Locking Fuel Cap .....	10511		2002; OE Equivalent Fuel Cap .....	10834	
2008-2007; Oil Filler Cap .....	10099		2002; Regular Locking Fuel Cap .....	10504	
2006; OE Equivalent Fuel Cap .....	10848		2002; Oil Filler Cap .....	10099	
2006; Regular Locking Fuel Cap .....	10518		<b>V-8 6.0 L</b>		
2006; Oil Filler Cap .....	10099		2009-2007; OE Type Radiator Cap .....	10248	15
2005-2004; OE Equivalent Fuel Cap .....	10836		2009-2007; OE Equivalent Fuel Cap .....	10841	
2005-2004; Regular Locking Fuel Cap .....	10506		2009-2007; Regular Locking Fuel Cap .....	10511	
2005-2004; Oil Filler Cap .....	10099		2009-2007; Oil Filler Cap .....	10099	
			<b>V-8 8.1 L</b>		
			2006-2005; OE Type Radiator Cap .....	10248	15

## Caps for Passenger Cars and Light Trucks (1990 and Newer)

Application	Part Number	PSI	Application	Part Number	PSI
<b>Chevrolet - Continued</b>			<b>Chevrolet - Continued</b>		
<b>Avalanche - Continued</b>			<b>C &amp; K Series Pickup - Continued</b>		
<b>V-8 8.1 L - Continued</b>			<b>V-6 4.3 L - Continued</b>		
2006-2005: OE Equivalent Fuel Cap .....	10841		1996-1995: OE Equivalent Fuel Cap .....	10817	
2006-2005: Regular Locking Fuel Cap .....	10511		1996-1995: Pre-Vent Non-Locking Fuel Cap .....	10819	
2006-2005: Oil Filler Cap .....	10099		1996-1995: Regular Locking Fuel Cap .....	10591	
2004: OE Type Radiator Cap .....	10248	15	1996-1995: Pre-Vent Locking Fuel Cap .....	10501	
2004: OE Equivalent Fuel Cap; W/O Threaded Filler Neck .....	10841		1996-1995: Oil Filler Cap .....	10099	
2004: Regular Locking Fuel Cap; W/O Threaded Filler Neck .....	10511				
2004: OE Equivalent Fuel Cap; W/Threaded Filler Neck .....	10834		<b>V-8 5.0 L</b>		
2004: Regular Locking Fuel Cap; W/Threaded Filler Neck .....	10504		1999-1998: Lev-R-Vent Radiator Cap .....	10331	16
2004: Oil Filler Cap .....	10099		1999-1998: OE Type Radiator Cap .....	10231	16
2003: OE Type Radiator Cap .....	10248	15	1999-1998: OE Equivalent Fuel Cap .....	10834	
2003: OE Equivalent Fuel Cap .....	10834		1999-1998: Regular Locking Fuel Cap .....	10504	
2003: Regular Locking Fuel Cap .....	10504		1999-1998: Oil Filler Cap .....	10105	
2003: Oil Filler Cap .....	10099		1997-1995: Lev-R-Vent Radiator Cap .....	10331	16
2002: OE Type Radiator Cap .....	10248	15	1997-1995: OE Type Radiator Cap .....	10231	16
2002: OE Equivalent Fuel Cap .....	10834		1997-1995: OE Equivalent Fuel Cap .....	10817	
2002: Regular Locking Fuel Cap .....	10504		1997-1995: Pre-Vent Non-Locking Fuel Cap .....	10819	
2002: Oil Filler Cap .....	10114		1997-1995: Regular Locking Fuel Cap .....	10591	
			1997-1995: Pre-Vent Locking Fuel Cap .....	10501	
			1997-1995: Oil Filler Cap .....	10105	
<b>Aveo</b>			<b>V-8 5.7 L</b>		
<b>4-Cyl. 1.6 L</b>			2000-1998: Lev-R-Vent Radiator Cap .....	10331	16
2011: OE Type Radiator Cap .....	10259	20	2000-1998: OE Type Radiator Cap .....	10231	16
2011: OE Equivalent Fuel Cap .....	10841		2000-1998: OE Equivalent Fuel Cap .....	10834	
2011: Regular Locking Fuel Cap .....	10511		2000-1998: Regular Locking Fuel Cap .....	10504	
2010: OE Type Radiator Cap .....	10259	20	2000-1998: Oil Filler Cap .....	10105	
2009-2004: OE Type Radiator Cap .....	10259	20	1997-1995: Lev-R-Vent Radiator Cap .....	10331	16
2009-2004: OE Equivalent Fuel Cap .....	10841		1997-1995: OE Type Radiator Cap .....	10231	16
2009-2004: Regular Locking Fuel Cap .....	10511		1997-1995: OE Equivalent Fuel Cap .....	10817	
<b>Beretta</b>			1997-1995: Pre-Vent Non-Locking Fuel Cap .....	10819	
<b>4-Cyl. 2.2 L</b>			1997-1995: Regular Locking Fuel Cap .....	10591	
1996-1995: OE Type Radiator Cap .....	10239	15	1997-1995: Pre-Vent Locking Fuel Cap .....	10501	
1996-1995: Pre-Vent Non-Locking Fuel Cap .....	10819		1997-1995: Oil Filler Cap .....	10105	
1996-1995: Pre-Vent Locking Fuel Cap .....	10501				
1996-1995: Oil Filler Cap .....	10122		<b>V-8 6.5 L Diesel</b>		
<b>V-6 3.1 L</b>			2002: Lev-R-Vent Radiator Cap .....	10330	16
1996-1995: OE Type Radiator Cap .....	10239	15	2002: OE Type Radiator Cap .....	10230	16
1996-1995: Pre-Vent Non-Locking Fuel Cap .....	10819		2002: OE Equivalent Fuel Cap .....	10830	
1996-1995: Pre-Vent Locking Fuel Cap .....	10501		2002: Diesel Regular Non-Locking Fuel Cap .....	10830D	
1996-1995: Oil Filler Cap .....	10099		2002: Pre-Vent Non-Locking Fuel Cap .....	10819	
			2002: Diesel Pre-Vent Non-Locking Fuel Cap .....	10819D	
<b>Blazer</b>			2002: Regular Locking Fuel Cap .....	10591	
<b>V-6 4.3 L</b>			2002: Diesel Regular Locking Fuel Cap .....	10591D	
2005-1996: Lev-R-Vent Radiator Cap .....	10330	16	2002: Pre-Vent Locking Fuel Cap .....	10501	
2005-1996: OE Type Radiator Cap .....	10230	16	2002: Diesel Only Pre-Vent Locking Fuel Cap .....	10501D	
2005-1996: OE Equivalent Fuel Cap .....	10836		2002: Oil Filler Cap .....	10099	
2005-1996: Regular Locking Fuel Cap .....	10506		2001: OE Type Radiator Cap .....	10248	15
2005-1996: Oil Filler Cap .....	10099		2001: OE Equivalent Fuel Cap .....	10830	
1995: Lev-R-Vent Radiator Cap .....	10331	16	2001: Diesel Regular Non-Locking Fuel Cap .....	10830D	
1995: OE Type Radiator Cap .....	10231	16	2001: Pre-Vent Non-Locking Fuel Cap .....	10819	
1995: OE Equivalent Fuel Cap .....	10817		2001: Diesel Pre-Vent Non-Locking Fuel Cap .....	10819D	
1995: Pre-Vent Non-Locking Fuel Cap .....	10819		2001: Regular Locking Fuel Cap .....	10591	
1995: Regular Locking Fuel Cap .....	10591		2001: Diesel Regular Locking Fuel Cap .....	10591D	
1995: Pre-Vent Locking Fuel Cap .....	10501		2001: Pre-Vent Locking Fuel Cap .....	10501	
1995: Oil Filler Cap .....	10099		2001: Diesel Only Pre-Vent Locking Fuel Cap .....	10501D	
<b>C &amp; K Series Pickup</b>			2001: Oil Filler Cap .....	10099	
<b>V-6 4.3 L</b>			2000: Lev-R-Vent Radiator Cap .....	10330	16
1998: Lev-R-Vent Radiator Cap .....	10331	16	2000: OE Type Radiator Cap .....	10230	16
1998: OE Type Radiator Cap .....	10231	16	2000: OE Equivalent Fuel Cap .....	10830	
1998: OE Equivalent Fuel Cap .....	10834		2000: Diesel Regular Non-Locking Fuel Cap .....	10830D	
1998: Regular Locking Fuel Cap .....	10504		2000: Pre-Vent Non-Locking Fuel Cap .....	10819	
1998: Oil Filler Cap .....	10099		2000: Diesel Pre-Vent Non-Locking Fuel Cap .....	10819D	
1997: Lev-R-Vent Radiator Cap .....	10331	16	2000: Regular Locking Fuel Cap .....	10591	
1997: OE Type Radiator Cap .....	10231	16	2000: Diesel Regular Locking Fuel Cap .....	10591D	
1997: OE Equivalent Fuel Cap; Fleetside .....	10817		2000: Pre-Vent Locking Fuel Cap .....	10501	
1997: Pre-Vent Non-Locking Fuel Cap; Fleetside .....	10819		2000: Diesel Only Pre-Vent Locking Fuel Cap .....	10501D	
1997: Regular Locking Fuel Cap; Fleetside .....	10591		2000: Oil Filler Cap .....	10099	
1997: Pre-Vent Locking Fuel Cap; Fleetside .....	10501		1999-1998: Lev-R-Vent Radiator Cap .....	10330	16
1997: OE Equivalent Fuel Cap; Stepside .....	10834		1999-1998: OE Type Radiator Cap .....	10230	16
1997: Regular Locking Fuel Cap; Stepside .....	10504		1999-1998: OE Equivalent Fuel Cap .....	10817	
1997: Oil Filler Cap .....	10099		1999-1998: Diesel Regular Non-Locking Fuel Cap .....	10830D	
1996-1995: Lev-R-Vent Radiator Cap .....	10331	16	1999-1998: Pre-Vent Non-Locking Fuel Cap .....	10819	
1996-1995: OE Type Radiator Cap .....	10231	16	1999-1998: Diesel Pre-Vent Non-Locking Fuel Cap .....	10819D	
			1999-1998: Regular Locking Fuel Cap .....	10591	
			1999-1998: Diesel Regular Locking Fuel Cap .....	10591D	

## Caps for Passenger Cars and Light Trucks (1990 and Newer)

Application	Part Number	PSI	Application	Part Number	PSI
<b>Chevrolet - Continued</b>			<b>Chevrolet - Continued</b>		
<b>C &amp; K Series Pickup - Continued</b>			<b>Camaro - Continued</b>		
<b>V-8 6.5 L Diesel - Continued</b>			<b>V-6 3.8 L - Continued</b>		
1999-1998: Pre-Vent Locking Fuel Cap .....	10501		2002-1999: OE Equivalent Fuel Cap .....	10836	
1999-1998: Diesel Only Pre-Vent Locking Fuel Cap .....	10501D		2002-1999: Regular Locking Fuel Cap .....	10506	
1999-1998: Oil Filler Cap .....	10099		2002-1999: Oil Filler Cap .....	10099	
1997: Lev-R-Vent Radiator Cap .....	10330	16	1998: Lev-R-Vent Radiator Cap .....	10334	18
1997: OE Type Radiator Cap .....	10230	16	1998: OE Type Radiator Cap .....	10234	18
1997: OE Equivalent Fuel Cap .....	10817		1998: Coolant Recovery Tank Cap .....	10236	
1997: Diesel Regular Non-Locking Fuel Cap .....	10830D		1998: OE Equivalent Fuel Cap .....	10846	
1997: Pre-Vent Non-Locking Fuel Cap .....	10819		1998: Regular Locking Fuel Cap .....	10516	
1997: Diesel Pre-Vent Non-Locking Fuel Cap .....	10819D		1998: Oil Filler Cap .....	10099	
1997: Regular Locking Fuel Cap .....	10591		1997-1995: Lev-R-Vent Radiator Cap .....	10334	18
1997: Diesel Regular Locking Fuel Cap .....	10591D		1997-1995: OE Type Radiator Cap .....	10234	18
1997: Pre-Vent Locking Fuel Cap .....	10501		1997-1995: Coolant Recovery Tank Cap .....	10236	
1997: Diesel Only Pre-Vent Locking Fuel Cap .....	10501D		1997-1995: OE Equivalent Fuel Cap .....	10822	
1997: Oil Filler Cap; W/Metal Oil Cap .....	10066		1997-1995: Pre-Vent Non-Locking Fuel Cap .....	10823	
1997: Oil Filler Cap; W/O Metal Oil Cap .....	10099		1997-1995: Regular Locking Fuel Cap .....	10594	
1996-1995: Lev-R-Vent Radiator Cap .....	10330	16	1997-1995: Oil Filler Cap .....	10099	
1996-1995: OE Type Radiator Cap .....	10230	16	<b>V-8 5.7 L</b>		
1996-1995: OE Equivalent Fuel Cap .....	10817		2002-1999: Lev-R-Vent Radiator Cap .....	10334	18
1996-1995: Diesel Regular Non-Locking Fuel Cap .....	10830D		2002-1999: OE Type Radiator Cap .....	10234	18
1996-1995: Pre-Vent Non-Locking Fuel Cap .....	10819		2002-1999: OE Equivalent Fuel Cap .....	10836	
1996-1995: Diesel Pre-Vent Non-Locking Fuel Cap .....	10819D		2002-1999: Regular Locking Fuel Cap .....	10506	
1996-1995: Regular Locking Fuel Cap .....	10591		2002-1999: Oil Filler Cap .....	10099	
1996-1995: Diesel Regular Locking Fuel Cap .....	10591D		1998: Lev-R-Vent Radiator Cap .....	10334	18
1996-1995: Pre-Vent Locking Fuel Cap .....	10501		1998: OE Type Radiator Cap .....	10234	18
1996-1995: Diesel Only Pre-Vent Locking Fuel Cap .....	10501D		1998: OE Equivalent Fuel Cap .....	10846	
1996-1995: Oil Filler Cap .....	10066		1998: Regular Locking Fuel Cap .....	10516	
<b>V-8 7.4 L</b>			1998: Oil Filler Cap .....	10099	
2000-1998: Lev-R-Vent Radiator Cap .....	10331	16	1997: Lev-R-Vent Radiator Cap .....	10334	18
2000-1998: OE Type Radiator Cap .....	10231	16	1997: OE Type Radiator Cap .....	10234	18
2000-1998: OE Equivalent Fuel Cap .....	10834		1997: OE Equivalent Fuel Cap .....	10822	
2000-1998: Regular Locking Fuel Cap .....	10504		1997: Pre-Vent Non-Locking Fuel Cap .....	10823	
2000-1998: Oil Filler Cap .....	10114		1997: Regular Locking Fuel Cap .....	10594	
1997-1996: Lev-R-Vent Radiator Cap .....	10331	16	1997: Oil Filler Cap .....	10105	
1997-1996: OE Type Radiator Cap .....	10231	16	1996-1995: Lev-R-Vent Radiator Cap .....	10334	18
1997-1996: OE Equivalent Fuel Cap .....	10817		1996-1995: OE Type Radiator Cap .....	10234	18
1997-1996: Pre-Vent Non-Locking Fuel Cap .....	10819		1996-1995: OE Equivalent Fuel Cap .....	10822	
1997-1996: Regular Locking Fuel Cap .....	10591		1996-1995: Pre-Vent Non-Locking Fuel Cap .....	10823	
1997-1996: Pre-Vent Locking Fuel Cap .....	10501		1996-1995: Regular Locking Fuel Cap .....	10594	
1997-1996: Oil Filler Cap .....	10114		1996-1995: Oil Filler Cap; W/Notched Oil Cap .....	10099	
1995: Lev-R-Vent Radiator Cap .....	10331	16	1996-1995: Oil Filler Cap; W/O Notched Oil Cap .....	10105	
1995: OE Type Radiator Cap .....	10231	16	<b>V-8 6.2 L</b>		
1995: OE Equivalent Fuel Cap .....	10817		2011-2010: OE Equivalent Fuel Cap .....	10834	
1995: Pre-Vent Non-Locking Fuel Cap .....	10819		2011-2010: Regular Locking Fuel Cap .....	10504	
1995: Regular Locking Fuel Cap .....	10591		2011-2010: Oil Filler Cap .....	10099	
1995: Pre-Vent Locking Fuel Cap .....	10501		<b>Caprice</b>		
1995: Oil Filler Cap .....	10105		<b>V-8 4.3 L</b>		
<b>V-8 8.1 L</b>			1996-1995: OE Type Radiator Cap .....	10239	15
2002-2001: Lev-R-Vent Radiator Cap .....	10331	16	1996-1995: OE Equivalent Fuel Cap .....	10817	
2002-2001: OE Type Radiator Cap .....	10231	16	1996-1995: Pre-Vent Non-Locking Fuel Cap .....	10819	
2002-2001: OE Equivalent Fuel Cap .....	10834		1996-1995: Regular Locking Fuel Cap .....	10591	
2002-2001: Regular Locking Fuel Cap .....	10504		1996-1995: Pre-Vent Locking Fuel Cap .....	10501	
2002-2001: Oil Filler Cap .....	10114		1996-1995: Oil Filler Cap .....	10105	
<b>Camaro</b>			<b>V-8 5.7 L</b>		
<b>V-6 3.4 L</b>			1996-1995: OE Type Radiator Cap .....	10239	15
1995: Lev-R-Vent Radiator Cap .....	10334	18	1996-1995: OE Equivalent Fuel Cap .....	10817	
1995: OE Type Radiator Cap .....	10234	18	1996-1995: Pre-Vent Non-Locking Fuel Cap .....	10819	
1995: Coolant Recovery Tank Cap .....	10236		1996-1995: Regular Locking Fuel Cap .....	10591	
1995: OE Equivalent Fuel Cap .....	10822		1996-1995: Pre-Vent Locking Fuel Cap .....	10501	
1995: Pre-Vent Non-Locking Fuel Cap .....	10823		1996-1995: Oil Filler Cap; W/Notched Oil Cap .....	10099	
1995: Regular Locking Fuel Cap .....	10594		1996-1995: Oil Filler Cap; W/O Notched Oil Cap .....	10105	
1995: Oil Filler Cap .....	10072		<b>V-8 6.0 L</b>		
<b>V-6 3.6 L</b>			2011: OE Equivalent Fuel Cap .....	10834	
2011: OE Equivalent Fuel Cap .....	10834		2011: Flex Fuel Regular Fuel Cap .....	10834Y	
2011: Regular Locking Fuel Cap .....	10504		2011: Regular Locking Fuel Cap .....	10504	
2010: OE Equivalent Fuel Cap .....	10834		2011: Flex Fuel Regular Locking Fuel Cap .....	10504Y	
2010: Regular Locking Fuel Cap .....	10504		2011: Oil Filler Cap .....	10099	
2010: Oil Filler Cap .....	10099		<b>Cavalier</b>		
<b>V-6 3.8 L</b>			<b>4-Cyl. 2.2 L</b>		
2002-1999: Lev-R-Vent Radiator Cap .....	10334	18	2005-2003: OE Type Radiator Cap .....	10248	15
2002-1999: OE Type Radiator Cap .....	10234	18	2005-2003: OE Equivalent Fuel Cap .....	10836	
2002-1999: Coolant Recovery Tank Cap .....	10236				

## Caps for Passenger Cars and Light Trucks (1990 and Newer)

Application	Part Number	PSI	Application	Part Number	PSI
<b>Chevrolet - Continued</b>			<b>Chevrolet - Continued</b>		
<b>Cavalier - Continued</b>			<b>Colorado - Continued</b>		
<b>4-Cyl. 2.2 L - Continued</b>			<b>5-Cyl. 3.5 L</b>		
2005-2003; Regular Locking Fuel Cap .....	10506		2006-2004; OE Type Radiator Cap .....	10248	15
2005-2003; Oil Filler Cap .....	10099		2006-2004; OE Equivalent Fuel Cap .....	10841	
2002; OE Type Radiator Cap .....	10248	15	2006-2004; Regular Locking Fuel Cap .....	10511	
2002; OE Equivalent Fuel Cap .....	10836		2006-2004; Oil Filler Cap .....	10099	
2002; Regular Locking Fuel Cap .....	10506		<b>5-Cyl. 3.7 L</b>		
2002; Oil Filler Cap; Eng. VIN F .....	10099		2011-2007; OE Type Radiator Cap .....	10248	15
2001-1999; OE Type Radiator Cap .....	10248	15	2011-2007; OE Equivalent Fuel Cap .....	10841	
2001-1999; OE Equivalent Fuel Cap .....	10836		2011-2007; Regular Locking Fuel Cap .....	10511	
2001-1999; Regular Locking Fuel Cap .....	10506		2011-2007; Oil Filler Cap .....	10099	
2001-1999; Oil Filler Cap .....	10123		<b>V-8 5.3 L</b>		
1998; OE Type Radiator Cap .....	10239	15	2011-2009; OE Type Radiator Cap .....	10248	15
1998; OE Equivalent Fuel Cap .....	10836		2011-2009; OE Equivalent Fuel Cap .....	10841	
1998; Regular Locking Fuel Cap .....	10506		2011-2009; Regular Locking Fuel Cap .....	10511	
1998; Oil Filler Cap .....	10123		2011-2009; Oil Filler Cap .....	10099	
1997; OE Type Radiator Cap .....	10239	15	<b>Corsica</b>		
1997; OE Equivalent Fuel Cap .....	10836		<b>4-Cyl. 2.2 L</b>		
1997; Regular Locking Fuel Cap .....	10506		1996-1995; OE Type Radiator Cap .....	10239	15
1997; Oil Filler Cap .....	10122		1996-1995; Pre-Vent Non-Locking Fuel Cap .....	10819	
1996-1995; OE Type Radiator Cap .....	10239	15	1996-1995; Pre-Vent Locking Fuel Cap .....	10501	
1996-1995; OE Equivalent Fuel Cap .....	10834		1996-1995; Oil Filler Cap .....	10122	
1996-1995; Regular Locking Fuel Cap .....	10504		<b>V-6 3.1 L</b>		
1996-1995; Oil Filler Cap .....	10122		1996-1995; OE Type Radiator Cap .....	10239	15
<b>4-Cyl. 2.3 L</b>			1996-1995; Pre-Vent Non-Locking Fuel Cap .....	10819	
1995; OE Type Radiator Cap .....	10239	15	1996-1995; Pre-Vent Locking Fuel Cap .....	10501	
1995; OE Equivalent Fuel Cap .....	10834		1996-1995; Oil Filler Cap .....	10099	
1995; Regular Locking Fuel Cap .....	10504		<b>Corvette</b>		
1995; Oil Filler Cap .....	10132		<b>V-8 5.7 L</b>		
<b>4-Cyl. 2.4 L</b>			2004-2001; OE Type Radiator Cap .....	10257	18
2002-1999; OE Type Radiator Cap .....	10248	15	2004-2001; OE Equivalent Fuel Cap .....	10836	
2002-1999; OE Equivalent Fuel Cap .....	10836		2004-2001; Regular Locking Fuel Cap .....	10506	
2002-1999; Regular Locking Fuel Cap .....	10506		2004-2001; Oil Filler Cap .....	10099	
2002-1999; Oil Filler Cap .....	10105		2000-1997; OE Type Radiator Cap .....	10239	15
1998-1997; OE Type Radiator Cap .....	10239	15	2000-1997; OE Equivalent Fuel Cap .....	10836	
1998-1997; OE Equivalent Fuel Cap .....	10836		2000-1997; Regular Locking Fuel Cap .....	10506	
1998-1997; Regular Locking Fuel Cap .....	10506		2000-1997; Oil Filler Cap .....	10099	
1998-1997; Oil Filler Cap .....	10105		1996; Lev-R-Vent Radiator Cap .....	10331	16
1996; OE Type Radiator Cap .....	10239	15	1996; OE Type Radiator Cap .....	10231	16
1996; OE Equivalent Fuel Cap .....	10834		1996; OE Equivalent Fuel Cap .....	10817	
1996; Regular Locking Fuel Cap .....	10504		1996; Pre-Vent Non-Locking Fuel Cap .....	10819	
1996; Oil Filler Cap .....	10105		1996; Regular Locking Fuel Cap .....	10591	
<b>Classic</b>			1996; Pre-Vent Locking Fuel Cap .....	10501	
<b>4-Cyl. 2.2 L</b>			1996; Oil Filler Cap; W/Notched Oil Cap .....	10099	
2005-2004; OE Type Radiator Cap .....	10248	15	1996; Oil Filler Cap; W/O Notched Oil Cap .....	10105	
2005-2004; OE Equivalent Fuel Cap .....	10836		1995; Lev-R-Vent Radiator Cap .....	10331	16
2005-2004; Regular Locking Fuel Cap .....	10506		1995; OE Type Radiator Cap .....	10231	16
2005-2004; Oil Filler Cap .....	10099		1995; OE Equivalent Fuel Cap .....	10817	
<b>Cobalt</b>			1995; Pre-Vent Non-Locking Fuel Cap .....	10819	
<b>4-Cyl. 2.0 L; 4-Cyl. 2.2 L</b>			1995; Regular Locking Fuel Cap .....	10591	
2010-2005; OE Type Radiator Cap .....	10248	15	1995; Pre-Vent Locking Fuel Cap .....	10501	
2010-2005; OE Equivalent Fuel Cap .....	10841		1995; Oil Filler Cap; Eng. VIN J .....	10105	
2010-2005; Regular Locking Fuel Cap .....	10511		1995; Oil Filler Cap; W/Notched Oil Cap; Eng. VIN P .....	10099	
2010-2005; Oil Filler Cap .....	10099		1995; Oil Filler Cap; W/O Notched Oil Cap; Eng. VIN P .....	10105	
<b>4-Cyl. 2.4 L</b>			<b>V-8 6.0 L</b>		
2008-2006; OE Type Radiator Cap .....	10248	15	2007; OE Equivalent Fuel Cap .....	10841	
2008-2006; OE Equivalent Fuel Cap .....	10841		2007; Regular Locking Fuel Cap .....	10511	
2008-2006; Regular Locking Fuel Cap .....	10511		2007; Oil Filler Cap .....	10099	
2008-2006; Oil Filler Cap .....	10099		2006; OE Equivalent Fuel Cap .....	10848	
<b>Colorado</b>			2006; Regular Locking Fuel Cap .....	10518	
<b>4-Cyl. 2.8 L</b>			2006; Oil Filler Cap .....	10099	
2006-2004; OE Type Radiator Cap .....	10248	15	2005; OE Equivalent Fuel Cap .....	10836	
2006-2004; OE Equivalent Fuel Cap .....	10841		2005; Regular Locking Fuel Cap .....	10506	
2006-2004; Regular Locking Fuel Cap .....	10511		2005; Oil Filler Cap .....	10099	
2006-2004; Oil Filler Cap .....	10099		<b>V-8 6.2 L</b>		
<b>4-Cyl. 2.9 L</b>			2011-2010; OE Equivalent Fuel Cap .....	10841	
2011-2007; OE Type Radiator Cap .....	10248	15	2011-2010; Regular Locking Fuel Cap .....	10511	
2011-2007; OE Equivalent Fuel Cap .....	10841		2011-2010; Oil Filler Cap .....	10099	
2011-2007; Regular Locking Fuel Cap .....	10511		2009; Oil Filler Cap .....	10099	
2011-2007; Oil Filler Cap .....	10099		2008; OE Equivalent Fuel Cap .....	10841	
			2008; Regular Locking Fuel Cap .....	10511	

## Caps for Passenger Cars and Light Trucks (1990 and Newer)

Application	Part Number	PSI	Application	Part Number	PSI
<b>Chevrolet - Continued</b>			<b>Chevrolet - Continued</b>		
<b>Corvette - Continued</b>			<b>Express - Continued</b>		
<b>V-8 6.2 L - Continued</b>			<b>V-6 4.3 L - Continued</b>		
2008; Oil Filler Cap .....	10099		2004; Regular Locking Fuel Cap .....	10506	
<b>V-8 7.0 L</b>			2004; Oil Filler Cap .....	10099	
2011-2010; OE Equivalent Fuel Cap .....	10841		2003; OE Type Radiator Cap .....	10248	15
2011-2010; Regular Locking Fuel Cap .....	10511		2003; OE Equivalent Fuel Cap .....	10836	
2011-2010; Oil Filler Cap .....	10099		2003; Regular Locking Fuel Cap .....	10522	
2009; Oil Filler Cap .....	10099		2003; Oil Filler Cap .....	10099	
2008-2007; OE Equivalent Fuel Cap .....	10841		2002-1998; Lev-R-Vent Radiator Cap .....	10331	16
2008-2007; Regular Locking Fuel Cap .....	10511		2002-1998; OE Type Radiator Cap .....	10231	16
2008-2007; Oil Filler Cap .....	10099		2002-1998; OE Equivalent Fuel Cap .....	10836	
2006; OE Equivalent Fuel Cap .....	10848		2002-1998; Regular Locking Fuel Cap .....	10522	
2006; Regular Locking Fuel Cap .....	10518		2002-1998; Oil Filler Cap .....	10114	
2006; Oil Filler Cap .....	10099		1997-1996; Lev-R-Vent Radiator Cap .....	10331	16
<b>Cruze</b>			1997-1996; OE Type Radiator Cap .....	10231	16
<b>4-Cyl. 1.4 L; 4-Cyl. 1.8 L</b>			1997-1996; OE Equivalent Fuel Cap .....	10817	
2011; OE Equivalent Fuel Cap .....	10841		1997-1996; Pre-Vent Non-Locking Fuel Cap .....	10819	
2011; Regular Locking Fuel Cap .....	10511		1997-1996; Regular Locking Fuel Cap .....	10591	
<b>Epica</b>			1997-1996; Pre-Vent Locking Fuel Cap .....	10501	
<b>6-Cyl. 2.5 L (Canada)</b>			1997-1996; Oil Filler Cap .....	10114	
2004; OE Type Radiator Cap .....	10259	20	<b>V-8 4.8 L</b>		
2004; OE Equivalent Fuel Cap .....	10834		2011-2010; OE Type Radiator Cap .....	10248	15
2004; Regular Locking Fuel Cap .....	10504		2011-2010; OE Equivalent Fuel Cap .....	10841	
<b>Equinox</b>			2011-2010; Flex Fuel Regular Fuel Cap .....	10841Y	
<b>4-Cyl. 2.4 L</b>			2011-2010; Regular Locking Fuel Cap .....	10523	
2011; OE Type Radiator Cap .....	10248	15	2011-2010; Oil Filler Cap .....	10099	
2011; OE Equivalent Fuel Cap .....	10834		2009-2006; OE Type Radiator Cap .....	10248	15
2011; Regular Locking Fuel Cap .....	10504		2009-2006; OE Equivalent Fuel Cap .....	10841	
2010; OE Type Radiator Cap .....	10248	15	2009-2006; Regular Locking Fuel Cap .....	10523	
2010; OE Equivalent Fuel Cap; W/Threaded Filler Neck .....	10834		2009-2006; Oil Filler Cap .....	10099	
2010; Regular Locking Fuel Cap; W/Threaded Filler Neck .....	10504		2005-2004; OE Type Radiator Cap .....	10248	15
2010; OE Equivalent Fuel Cap; W/O Threaded Filler Neck .....	10841		2005-2004; OE Equivalent Fuel Cap .....	10848	
2010; Regular Locking Fuel Cap; W/O Threaded Filler Neck .....	10511		2005-2004; Regular Locking Fuel Cap .....	10518	
2010; Oil Filler Cap .....	10099		2005-2004; Oil Filler Cap .....	10099	
<b>V-6 3.0 L</b>			2003; OE Type Radiator Cap .....	10248	15
2011; OE Type Radiator Cap .....	10248	15	2003; OE Equivalent Fuel Cap .....	10836	
2011; OE Equivalent Fuel Cap .....	10834		2003; Regular Locking Fuel Cap .....	10522	
2011; Regular Locking Fuel Cap .....	10504		2003; Oil Filler Cap .....	10099	
2011; Flex Fuel Regular Fuel Cap .....	10834Y		<b>V-8 5.0 L</b>		
2011; Flex Fuel Regular Locking Fuel Cap .....	10504Y		2002-1998; Lev-R-Vent Radiator Cap .....	10331	16
2010; OE Type Radiator Cap .....	10248	15	2002-1998; OE Type Radiator Cap .....	10231	16
2010; OE Equivalent Fuel Cap .....	10834		2002-1998; OE Equivalent Fuel Cap .....	10836	
2010; Regular Locking Fuel Cap .....	10504		2002-1998; Regular Locking Fuel Cap .....	10522	
2010; Oil Filler Cap .....	10099		2002-1998; Oil Filler Cap .....	10114	
<b>V-6 3.4 L</b>			1997-1996; Lev-R-Vent Radiator Cap .....	10331	16
2009-2005; OE Type Radiator Cap .....	10248	15	1997-1996; OE Type Radiator Cap .....	10231	16
2009-2005; OE Equivalent Fuel Cap .....	10841		1997-1996; OE Equivalent Fuel Cap .....	10817	
2009-2005; Regular Locking Fuel Cap .....	10511		1997-1996; Pre-Vent Non-Locking Fuel Cap .....	10819	
2009-2005; Oil Filler Cap .....	10099		1997-1996; Regular Locking Fuel Cap .....	10591	
<b>V-6 3.6 L</b>			1997-1996; Pre-Vent Locking Fuel Cap .....	10501	
2009-2008; OE Type Radiator Cap .....	10248	15	1997-1996; Oil Filler Cap .....	10114	
2009-2008; OE Equivalent Fuel Cap .....	10841		<b>V-8 5.3 L</b>		
2009-2008; Regular Locking Fuel Cap .....	10511		2011-2010; OE Type Radiator Cap .....	10248	15
2009-2008; Oil Filler Cap .....	10099		2011-2010; OE Equivalent Fuel Cap .....	10841	
<b>Express</b>			2011-2010; Flex Fuel Regular Fuel Cap .....	10841Y	
<b>V-6 4.3 L</b>			2011-2010; Regular Locking Fuel Cap .....	10523	
2011; OE Type Radiator Cap .....	10248	15	2011-2010; Oil Filler Cap .....	10099	
2011; OE Equivalent Fuel Cap .....	10841		2009; OE Type Radiator Cap .....	10248	15
2011; Regular Locking Fuel Cap .....	10511		2009; OE Equivalent Fuel Cap .....	10841	
2011; Oil Filler Cap .....	10099		2009; Flex Fuel Regular Fuel Cap .....	10841Y	
2010-2006; OE Type Radiator Cap .....	10248	15	2009; Regular Locking Fuel Cap .....	10523	
2010-2006; OE Equivalent Fuel Cap .....	10841		2009; Oil Filler Cap .....	10099	
2010-2006; Regular Locking Fuel Cap .....	10523		2008; OE Type Radiator Cap .....	10248	15
2010-2006; Oil Filler Cap .....	10099		2008; OE Equivalent Fuel Cap .....	10841	
2005; OE Type Radiator Cap .....	10248	15	2008; Regular Locking Fuel Cap .....	10523	
2005; OE Equivalent Fuel Cap .....	10848		2008; Oil Filler Cap .....	10099	
2005; Regular Locking Fuel Cap .....	10518		2007; OE Type Radiator Cap .....	10248	15
2005; Oil Filler Cap .....	10099		2007; OE Equivalent Fuel Cap .....	10841	
2004; OE Type Radiator Cap .....	10248	15	2007; Flex Fuel Regular Fuel Cap .....	10841Y	
2004; OE Equivalent Fuel Cap .....	10836		2007; Regular Locking Fuel Cap .....	10523	
			2007; Oil Filler Cap .....	10099	
			2006; OE Type Radiator Cap .....	10248	15
			2006; OE Equivalent Fuel Cap .....	10841	
			2006; Regular Locking Fuel Cap .....	10523	

## Caps for Passenger Cars and Light Trucks (1990 and Newer)

Application	Part Number	PSI	Application	Part Number	PSI
<b>Chevrolet - Continued</b>			<b>Chevrolet - Continued</b>		
<b>Express - Continued</b>			<b>Express - Continued</b>		
<b>V-8 5.3 L - Continued</b>			<b>V-8 6.5 L Diesel - Continued</b>		
2006; Oil Filler Cap .....	10099		2000; Oil Filler Cap .....	10099	
2005-2004; OE Type Radiator Cap .....	10248	15	1999; Lev-R-Vent Radiator Cap .....	10330	16
2005-2004; OE Equivalent Fuel Cap .....	10848		1999; OE Type Radiator Cap .....	10230	16
2005-2004; Regular Locking Fuel Cap .....	10518		1999; OE Equivalent Fuel Cap .....	10836	
2005-2004; Oil Filler Cap .....	10099		1999; Regular Locking Fuel Cap .....	10522	
2003; OE Type Radiator Cap .....	10248	15	1999; Oil Filler Cap .....	10099	
2003; OE Equivalent Fuel Cap .....	10836		1998; Lev-R-Vent Radiator Cap .....	10330	16
2003; Regular Locking Fuel Cap .....	10522		1998; OE Type Radiator Cap .....	10230	16
2003; Oil Filler Cap .....	10099		1998; OE Equivalent Fuel Cap .....	10817	
<b>V-8 5.7 L</b>			1998; Diesel Regular Non-Locking Fuel Cap .....	10830D	
2002-1998; Lev-R-Vent Radiator Cap .....	10331	16	1998; Pre-Vent Non-Locking Fuel Cap .....	10819	
2002-1998; OE Type Radiator Cap .....	10231	16	1998; Diesel Pre-Vent Non-Locking Fuel Cap .....	10819D	
2002-1998; OE Equivalent Fuel Cap .....	10836		1998; Regular Locking Fuel Cap .....	10591	
2002-1998; Regular Locking Fuel Cap .....	10522		1998; Diesel Regular Locking Fuel Cap .....	10591D	
2002-1998; Oil Filler Cap .....	10114		1998; Pre-Vent Locking Fuel Cap .....	10501	
1997-1996; Lev-R-Vent Radiator Cap .....	10331	16	1998; Diesel Only Pre-Vent Locking Fuel Cap .....	10501D	
1997-1996; OE Type Radiator Cap .....	10231	16	1998; Oil Filler Cap .....	10099	
1997-1996; OE Equivalent Fuel Cap .....	10817		1997; Lev-R-Vent Radiator Cap .....	10330	16
1997-1996; Pre-Vent Non-Locking Fuel Cap .....	10819		1997; OE Type Radiator Cap .....	10230	16
1997-1996; Regular Locking Fuel Cap .....	10591		1997; OE Equivalent Fuel Cap .....	10817	
1997-1996; Pre-Vent Locking Fuel Cap .....	10501		1997; Diesel Regular Non-Locking Fuel Cap .....	10830D	
1997-1996; Oil Filler Cap .....	10114		1997; Pre-Vent Non-Locking Fuel Cap .....	10819	
<b>V-8 6.0 L</b>			1997; Diesel Pre-Vent Non-Locking Fuel Cap .....	10819D	
2011-2010; OE Type Radiator Cap .....	10248	15	1997; Regular Locking Fuel Cap .....	10591	
2011-2010; OE Equivalent Fuel Cap .....	10841		1997; Diesel Regular Locking Fuel Cap .....	10591D	
2011-2010; Flex Fuel Regular Fuel Cap .....	10841Y		1997; Pre-Vent Locking Fuel Cap .....	10501	
2011-2010; Regular Locking Fuel Cap .....	10523		1997; Diesel Only Pre-Vent Locking Fuel Cap .....	10501D	
2011-2010; Oil Filler Cap .....	10099		1997; Oil Filler Cap; W/Metal Oil Cap .....	10066	
2009-2006; OE Type Radiator Cap .....	10248	15	1997; Oil Filler Cap; W/O Metal Oil Cap .....	10099	
2009-2006; OE Equivalent Fuel Cap .....	10841		1996; Lev-R-Vent Radiator Cap .....	10330	16
2009-2006; Regular Locking Fuel Cap .....	10523		1996; OE Type Radiator Cap .....	10230	16
2009-2006; Oil Filler Cap .....	10099		1996; OE Equivalent Fuel Cap .....	10817	
2005-2004; OE Type Radiator Cap .....	10248	15	1996; Diesel Regular Non-Locking Fuel Cap .....	10830D	
2005-2004; OE Equivalent Fuel Cap .....	10848		1996; Pre-Vent Non-Locking Fuel Cap .....	10819	
2005-2004; Regular Locking Fuel Cap .....	10518		1996; Diesel Pre-Vent Non-Locking Fuel Cap .....	10819D	
2005-2004; Oil Filler Cap .....	10099		1996; Regular Locking Fuel Cap .....	10591	
2003; OE Type Radiator Cap .....	10248	15	1996; Diesel Regular Locking Fuel Cap .....	10591D	
2003; OE Equivalent Fuel Cap .....	10836		1996; Pre-Vent Locking Fuel Cap .....	10501	
2003; Regular Locking Fuel Cap .....	10522		1996; Diesel Only Pre-Vent Locking Fuel Cap .....	10501D	
2003; Oil Filler Cap .....	10099		1996; Oil Filler Cap .....	10066	
<b>V-8 6.5 L Diesel</b>			<b>V-8 6.6 L Diesel</b>		
2002; Lev-R-Vent Radiator Cap .....	10330	16	2011; OE Equivalent Fuel Cap .....	10830	
2002; OE Type Radiator Cap .....	10230	16	2011; Diesel Regular Non-Locking Fuel Cap .....	10830D	
2002; OE Equivalent Fuel Cap .....	10830		2011; Pre-Vent Non-Locking Fuel Cap .....	10819	
2002; Diesel Regular Non-Locking Fuel Cap .....	10830D		2011; Diesel Pre-Vent Non-Locking Fuel Cap .....	10819D	
2002; Pre-Vent Non-Locking Fuel Cap .....	10819		2011; Regular Locking Fuel Cap .....	10591	
2002; Diesel Pre-Vent Non-Locking Fuel Cap .....	10819D		2011; Diesel Regular Locking Fuel Cap .....	10591D	
2002; Regular Locking Fuel Cap .....	10591		2011; Pre-Vent Locking Fuel Cap .....	10501	
2002; Diesel Regular Locking Fuel Cap .....	10591D		2011; Diesel Only Pre-Vent Locking Fuel Cap .....	10501D	
2002; Pre-Vent Locking Fuel Cap .....	10501		2011; Oil Filler Cap .....	10099	
2002; Diesel Only Pre-Vent Locking Fuel Cap .....	10501D		2010-2006; OE Type Radiator Cap .....	10248	15
2002; Oil Filler Cap .....	10099		2010-2006; OE Equivalent Fuel Cap .....	10830	
2001; OE Type Radiator Cap .....	10248	15	2010-2006; Diesel Regular Non-Locking Fuel Cap .....	10830D	
2001; OE Equivalent Fuel Cap .....	10830		2010-2006; Pre-Vent Non-Locking Fuel Cap .....	10819	
2001; Diesel Regular Non-Locking Fuel Cap .....	10830D		2010-2006; Diesel Pre-Vent Non-Locking Fuel Cap .....	10819D	
2001; Pre-Vent Non-Locking Fuel Cap .....	10819		2010-2006; Regular Locking Fuel Cap .....	10591	
2001; Diesel Pre-Vent Non-Locking Fuel Cap .....	10819D		2010-2006; Diesel Regular Locking Fuel Cap .....	10591D	
2001; Regular Locking Fuel Cap .....	10591		2010-2006; Pre-Vent Locking Fuel Cap .....	10501	
2001; Diesel Regular Locking Fuel Cap .....	10591D		2010-2006; Diesel Only Pre-Vent Locking Fuel Cap .....	10501D	
2001; Pre-Vent Locking Fuel Cap .....	10501		2010-2006; Oil Filler Cap .....	10099	
2001; Diesel Only Pre-Vent Locking Fuel Cap .....	10501D		<b>V-8 7.4 L</b>		
2001; Oil Filler Cap .....	10099		2000-1998; Lev-R-Vent Radiator Cap .....	10331	16
2000; Lev-R-Vent Radiator Cap .....	10331	16	2000-1998; OE Type Radiator Cap .....	10231	16
2000; OE Type Radiator Cap .....	10231	16	2000-1998; OE Equivalent Fuel Cap .....	10836	
2000; OE Equivalent Fuel Cap .....	10830		2000-1998; Regular Locking Fuel Cap .....	10522	
2000; Diesel Regular Non-Locking Fuel Cap .....	10830D		2000-1998; Oil Filler Cap .....	10114	
2000; Pre-Vent Non-Locking Fuel Cap .....	10819		1997-1996; Lev-R-Vent Radiator Cap .....	10331	16
2000; Diesel Pre-Vent Non-Locking Fuel Cap .....	10819D		1997-1996; OE Type Radiator Cap .....	10231	16
2000; Regular Locking Fuel Cap .....	10591		1997-1996; OE Equivalent Fuel Cap .....	10817	
2000; Diesel Regular Locking Fuel Cap .....	10591D		1997-1996; Pre-Vent Non-Locking Fuel Cap .....	10819	
2000; Pre-Vent Locking Fuel Cap .....	10501		1997-1996; Regular Locking Fuel Cap .....	10591	
2000; Diesel Only Pre-Vent Locking Fuel Cap .....	10501D		1997-1996; Pre-Vent Locking Fuel Cap .....	10501	

## Caps for Passenger Cars and Light Trucks (1990 and Newer)

Application	Part Number	PSI	Application	Part Number	PSI
<b>Chevrolet - Continued</b>			<b>Chevrolet - Continued</b>		
<b>Express - Continued</b>			<b>G Series Van - Continued</b>		
<b>V-8 7.4 L - Continued</b>			<b>V-8 5.7 L - Continued</b>		
1997-1996; Oil Filler Cap .....	10114		1996; OE Equivalent Fuel Cap .....	10817	
<b>V-8 8.1 L</b>			1996; Pre-Vent Non-Locking Fuel Cap .....	10819	
2002-2001; Lev-R-Vent Radiator Cap .....	10331	16	1996; Regular Locking Fuel Cap .....	10591	
2002-2001; OE Type Radiator Cap .....	10231	16	1996; Pre-Vent Locking Fuel Cap .....	10501	
2002-2001; OE Equivalent Fuel Cap .....	10836		1996; Oil Filler Cap; Eng. VIN K .....	10072	
2002-2001; Regular Locking Fuel Cap .....	10522		1996; Oil Filler Cap; Eng. VIN R .....	10114	
2002-2001; Oil Filler Cap .....	10114		1995; Lev-R-Vent Radiator Cap .....	10331	16
<b>G Series Van</b>			1995; OE Type Radiator Cap .....	10231	16
<b>V-6 4.3 L</b>			1995; OE Equivalent Fuel Cap .....	10817	
1998; Lev-R-Vent Radiator Cap .....	10331	16	1995; Pre-Vent Non-Locking Fuel Cap .....	10819	
1998; OE Type Radiator Cap .....	10231	16	1995; Regular Locking Fuel Cap .....	10591	
1998; OE Equivalent Fuel Cap .....	10836		1995; Pre-Vent Locking Fuel Cap .....	10501	
1998; Regular Locking Fuel Cap .....	10506		1995; Oil Filler Cap .....	10072	
1998; Oil Filler Cap .....	10114		<b>V-8 6.5 L Diesel</b>		
1997; Lev-R-Vent Radiator Cap .....	10331	16	1998; Lev-R-Vent Radiator Cap .....	10330	16
1997; OE Type Radiator Cap .....	10231	16	1998; OE Type Radiator Cap .....	10230	16
1997; OE Equivalent Fuel Cap .....	10817		1998; Oil Filler Cap .....	10099	
1997; Pre-Vent Non-Locking Fuel Cap .....	10819		1997; Lev-R-Vent Radiator Cap .....	10330	16
1997; Regular Locking Fuel Cap .....	10591		1997; OE Type Radiator Cap .....	10230	16
1997; Pre-Vent Locking Fuel Cap .....	10501		1997; Oil Filler Cap; W/Metal Oil Cap .....	10066	
1997; Oil Filler Cap .....	10114		1997; Oil Filler Cap; W/O Metal Oil Cap .....	10099	
1996; Lev-R-Vent Radiator Cap .....	10331	16	1996-1995; Lev-R-Vent Radiator Cap .....	10330	16
1996; OE Type Radiator Cap .....	10231	16	1996-1995; OE Type Radiator Cap .....	10230	16
1996; OE Equivalent Fuel Cap .....	10817		1996-1995; OE Equivalent Fuel Cap .....	10817	
1996; Pre-Vent Non-Locking Fuel Cap .....	10819		1996-1995; Diesel Regular Non-Locking Fuel Cap .....	10830D	
1996; Regular Locking Fuel Cap .....	10591		1996-1995; Pre-Vent Non-Locking Fuel Cap .....	10819	
1996; Pre-Vent Locking Fuel Cap .....	10501		1996-1995; Diesel Pre-Vent Non-Locking Fuel Cap .....	10819D	
1996; Oil Filler Cap; Eng. VIN W .....	10114		1996-1995; Regular Locking Fuel Cap .....	10591	
1996; Oil Filler Cap; Eng. VIN Z .....	10072		1996-1995; Diesel Regular Locking Fuel Cap .....	10591D	
1995; Lev-R-Vent Radiator Cap .....	10331	16	1996-1995; Pre-Vent Locking Fuel Cap .....	10501	
1995; OE Type Radiator Cap .....	10231	16	1996-1995; Diesel Only Pre-Vent Locking Fuel Cap .....	10501D	
1995; OE Equivalent Fuel Cap .....	10817		1996-1995; Oil Filler Cap .....	10066	
1995; Pre-Vent Non-Locking Fuel Cap .....	10819		<b>V-8 7.4 L</b>		
1995; Regular Locking Fuel Cap .....	10591		1998; Lev-R-Vent Radiator Cap .....	10331	16
1995; Pre-Vent Locking Fuel Cap .....	10501		1998; OE Type Radiator Cap .....	10231	16
1995; Oil Filler Cap .....	10072		1998; OE Equivalent Fuel Cap .....	10836	
<b>V-8 5.0 L</b>			1998; Regular Locking Fuel Cap .....	10506	
1998; Lev-R-Vent Radiator Cap .....	10331	16	1998; Oil Filler Cap .....	10114	
1998; OE Type Radiator Cap .....	10231	16	1997-1996; Lev-R-Vent Radiator Cap .....	10331	16
1998; OE Equivalent Fuel Cap .....	10836		1997-1996; OE Type Radiator Cap .....	10231	16
1998; Regular Locking Fuel Cap .....	10506		1997-1996; OE Equivalent Fuel Cap .....	10817	
1998; Oil Filler Cap .....	10114		1997-1996; Pre-Vent Non-Locking Fuel Cap .....	10819	
1997-1996; Lev-R-Vent Radiator Cap .....	10331	16	1997-1996; Regular Locking Fuel Cap .....	10591	
1997-1996; OE Type Radiator Cap .....	10231	16	1997-1996; Pre-Vent Locking Fuel Cap .....	10501	
1997-1996; OE Equivalent Fuel Cap .....	10817		1997-1996; Oil Filler Cap; Eng. VIN J .....	10114	
1997-1996; Pre-Vent Non-Locking Fuel Cap .....	10819		1997-1996; Oil Filler Cap; Eng. VIN N .....	10105	
1997-1996; Regular Locking Fuel Cap .....	10591		1995; Lev-R-Vent Radiator Cap .....	10331	16
1997-1996; Pre-Vent Locking Fuel Cap .....	10501		1995; OE Type Radiator Cap .....	10231	16
1997-1996; Oil Filler Cap .....	10114		1995; OE Equivalent Fuel Cap .....	10817	
1995; Lev-R-Vent Radiator Cap .....	10331	16	1995; Pre-Vent Non-Locking Fuel Cap .....	10819	
1995; OE Type Radiator Cap .....	10231	16	1995; Regular Locking Fuel Cap .....	10591	
1995; OE Equivalent Fuel Cap .....	10817		1995; Pre-Vent Locking Fuel Cap .....	10501	
1995; Pre-Vent Non-Locking Fuel Cap .....	10819		1995; Oil Filler Cap .....	10105	
1995; Regular Locking Fuel Cap .....	10591		<b>HHR</b>		
1995; Pre-Vent Locking Fuel Cap .....	10501		<b>4-Cyl. 2.0 L</b>		
1995; Oil Filler Cap .....	10072		2010-2008; OE Type Radiator Cap .....	10248	15
<b>V-8 5.7 L</b>			2010-2008; OE Equivalent Fuel Cap .....	10841	
1998; Lev-R-Vent Radiator Cap .....	10331	16	2010-2008; Regular Locking Fuel Cap .....	10523	
1998; OE Type Radiator Cap .....	10231	16	2010-2008; Oil Filler Cap .....	10099	
1998; OE Equivalent Fuel Cap .....	10836		<b>4-Cyl. 2.2 L</b>		
1998; Regular Locking Fuel Cap .....	10506		2011-2010; OE Type Radiator Cap .....	10248	15
1998; Oil Filler Cap .....	10114		2011-2010; OE Equivalent Fuel Cap .....	10841	
1997; Lev-R-Vent Radiator Cap .....	10331	16	2011-2010; Flex Fuel Regular Fuel Cap .....	10841Y	
1997; OE Type Radiator Cap .....	10231	16	2011-2010; Regular Locking Fuel Cap .....	10523	
1997; OE Equivalent Fuel Cap .....	10817		2011-2010; Oil Filler Cap .....	10099	
1997; Pre-Vent Non-Locking Fuel Cap .....	10819		2009-2006; OE Type Radiator Cap .....	10248	15
1997; Regular Locking Fuel Cap .....	10591		2009-2006; OE Equivalent Fuel Cap .....	10841	
1997; Pre-Vent Locking Fuel Cap .....	10501		2009-2006; Regular Locking Fuel Cap .....	10523	
1997; Oil Filler Cap .....	10114		2009-2006; Oil Filler Cap .....	10099	
1996; Lev-R-Vent Radiator Cap .....	10331	16	<b>4-Cyl. 2.4 L</b>		
1996; OE Type Radiator Cap .....	10231	16	2011; OE Type Radiator Cap .....	10248	15

## Caps for Passenger Cars and Light Trucks (1990 and Newer)

Application	Part Number	PSI	Application	Part Number	PSI
<b>Chevrolet - Continued</b>			<b>Chevrolet - Continued</b>		
<b>HHR - Continued</b>			<b>Impala - Continued</b>		
<b>4-Cyl. 2.4 L - Continued</b>			<b>V-6 3.9 L - Continued</b>		
2011; OE Equivalent Fuel Cap .....	10841		2009-2008; Flex Fuel Regular Locking Fuel Cap .....	10511Y	
2011; Flex Fuel Regular Fuel Cap .....	10841Y		2009-2008; Oil Filler Cap .....	10099	
2011; Regular Locking Fuel Cap .....	10523		2007-2006; OE Equivalent Fuel Cap .....	10841	
2010; OE Type Radiator Cap .....	10248	15	2007-2006; Regular Locking Fuel Cap .....	10511	
2010; OE Equivalent Fuel Cap .....	10841		2007-2006; Oil Filler Cap .....	10099	
2010; Flex Fuel Regular Fuel Cap .....	10841Y		<b>V-8 5.3 L</b>		
2010; Regular Locking Fuel Cap .....	10523		2009-2006; OE Equivalent Fuel Cap .....	10841	
2010; Oil Filler Cap .....	10099		2009-2006; Regular Locking Fuel Cap .....	10511	
2009-2008; OE Type Radiator Cap .....	10248	15	2009-2006; Oil Filler Cap .....	10099	
2009-2008; OE Equivalent Fuel Cap .....	10841		<b>Impala SS</b>		
2009-2008; Regular Locking Fuel Cap .....	10523		<b>V-8 5.7 L</b>		
2009-2008; Oil Filler Cap .....	10099		1996-1995; OE Type Radiator Cap .....	10239	15
2007; OE Equivalent Fuel Cap .....	10841		1996-1995; OE Equivalent Fuel Cap .....	10817	
2007; Regular Locking Fuel Cap .....	10523		1996-1995; Pre-Vent Non-Locking Fuel Cap .....	10819	
2007; Oil Filler Cap .....	10099		1996-1995; Regular Locking Fuel Cap .....	10591	
2006; OE Type Radiator Cap .....	10248	15	1996-1995; Pre-Vent Locking Fuel Cap .....	10501	
2006; OE Equivalent Fuel Cap .....	10841		1996-1995; Oil Filler Cap; W/Notched Oil Cap .....	10099	
2006; Regular Locking Fuel Cap .....	10523		1996-1995; Oil Filler Cap; W/O Notched Oil Cap .....	10105	
2006; Oil Filler Cap .....	10099		<b>LLV (Postal Vehicle)</b>		
<b>Impala</b>			<b>4-Cyl. 2.2 L</b>		
<b>V-6 3.4 L</b>			1995; Lev-R-Vent Radiator Cap .....	10331	16
2005-2004; OE Type Radiator Cap .....	10248	15	1995; OE Type Radiator Cap .....	10231	16
2005-2004; OE Equivalent Fuel Cap .....	10836		1995; OE Equivalent Fuel Cap .....	10817	
2005-2004; Regular Locking Fuel Cap .....	10506		1995; Pre-Vent Non-Locking Fuel Cap .....	10819	
2005-2004; Oil Filler Cap .....	10099		1995; Regular Locking Fuel Cap .....	10591	
2003-2000; Lev-R-Vent Radiator Cap .....	10331	16	1995; Pre-Vent Locking Fuel Cap .....	10501	
2003-2000; OE Type Radiator Cap .....	10231	16	<b>Lumina</b>		
2003-2000; OE Equivalent Fuel Cap .....	10836		<b>V-6 3.1 L</b>		
2003-2000; Regular Locking Fuel Cap .....	10506		2001-1997; Lev-R-Vent Radiator Cap .....	10331	16
2003-2000; Oil Filler Cap .....	10099		2001-1997; OE Type Radiator Cap .....	10231	16
<b>V-6 3.5 L</b>			2001-1997; OE Equivalent Fuel Cap .....	10836	
2011-2010; OE Equivalent Fuel Cap .....	10841		2001-1997; Regular Locking Fuel Cap .....	10506	
2011-2010; Flex Fuel Regular Fuel Cap .....	10841Y		2001-1997; Oil Filler Cap .....	10099	
2011-2010; Regular Locking Fuel Cap .....	10511		1996-1995; Lev-R-Vent Radiator Cap .....	10331	16
2011-2010; Flex Fuel Regular Locking Fuel Cap .....	10511Y		1996-1995; OE Type Radiator Cap .....	10231	16
2011-2010; Oil Filler Cap .....	10099		1996-1995; OE Equivalent Fuel Cap .....	10817	
2009; OE Equivalent Fuel Cap .....	10841		1996-1995; Pre-Vent Non-Locking Fuel Cap .....	10819	
2009; Regular Locking Fuel Cap .....	10511		1996-1995; Regular Locking Fuel Cap .....	10591	
2009; Oil Filler Cap .....	10099		1996-1995; Pre-Vent Locking Fuel Cap .....	10501	
2008; OE Equivalent Fuel Cap .....	10841		1996-1995; Oil Filler Cap .....	10099	
2008; Regular Locking Fuel Cap .....	10511		<b>V-6 3.4 L</b>		
2008; Flex Fuel Regular Fuel Cap .....	10841Y		1997; Lev-R-Vent Radiator Cap .....	10331	16
2008; Flex Fuel Regular Locking Fuel Cap .....	10511Y		1997; OE Type Radiator Cap .....	10231	16
2008; Oil Filler Cap .....	10099		1997; OE Equivalent Fuel Cap .....	10836	
2007; OE Equivalent Fuel Cap .....	10841		1997; Regular Locking Fuel Cap .....	10506	
2007; Flex Fuel Regular Fuel Cap .....	10841Y		1996-1995; Lev-R-Vent Radiator Cap .....	10331	16
2007; Regular Locking Fuel Cap .....	10511		1996-1995; OE Type Radiator Cap .....	10231	16
2007; Flex Fuel Regular Locking Fuel Cap .....	10511Y		1996-1995; OE Equivalent Fuel Cap .....	10817	
2007; Oil Filler Cap .....	10099		1996-1995; Pre-Vent Non-Locking Fuel Cap .....	10819	
2006; OE Equivalent Fuel Cap .....	10841		1996-1995; Regular Locking Fuel Cap .....	10591	
2006; Regular Locking Fuel Cap .....	10511		1996-1995; Pre-Vent Locking Fuel Cap .....	10501	
2006; Oil Filler Cap .....	10099		1996-1995; Oil Filler Cap .....	10119	
<b>V-6 3.8 L</b>			<b>V-6 3.8 L</b>		
2005-2004; OE Type Radiator Cap .....	10248	15	1999-1998; Lev-R-Vent Radiator Cap .....	10331	16
2005-2004; OE Equivalent Fuel Cap .....	10836		1999-1998; OE Type Radiator Cap .....	10231	16
2005-2004; Regular Locking Fuel Cap .....	10506		1999-1998; OE Equivalent Fuel Cap .....	10836	
2005-2004; Oil Filler Cap .....	10099		1999-1998; Regular Locking Fuel Cap .....	10506	
2003-2000; Lev-R-Vent Radiator Cap .....	10331	16	1999-1998; Oil Filler Cap .....	10099	
2003-2000; OE Type Radiator Cap .....	10231	16	<b>Lumina APV</b>		
2003-2000; OE Equivalent Fuel Cap .....	10836		<b>V-6 3.1 L</b>		
2003-2000; Regular Locking Fuel Cap .....	10506		1995; Lev-R-Vent Radiator Cap .....	10331	16
2003-2000; Oil Filler Cap .....	10099		1995; OE Type Radiator Cap .....	10231	16
<b>V-6 3.9 L</b>			1995; OE Equivalent Fuel Cap .....	10817	
2011-2010; OE Equivalent Fuel Cap .....	10841		1995; Pre-Vent Non-Locking Fuel Cap .....	10819	
2011-2010; Flex Fuel Regular Fuel Cap .....	10841Y		1995; Regular Locking Fuel Cap .....	10591	
2011-2010; Regular Locking Fuel Cap .....	10511		1995; Pre-Vent Locking Fuel Cap .....	10501	
2011-2010; Flex Fuel Regular Locking Fuel Cap .....	10511Y		1995; Oil Filler Cap .....	10072	
2011-2010; Oil Filler Cap .....	10099				
2009-2008; OE Equivalent Fuel Cap .....	10841				
2009-2008; Regular Locking Fuel Cap .....	10511				
2009-2008; Flex Fuel Regular Fuel Cap .....	10841Y				



## Caps for Passenger Cars and Light Trucks (1990 and Newer)

Application	Part Number	PSI	Application	Part Number	PSI
<b>Chevrolet - Continued</b>			<b>Chevrolet - Continued</b>		
<b>Lumina APV - Continued</b>			<b>Malibu - Continued</b>		
<b>V-6 3.4 L</b>			<b>V-6 3.6 L</b>		
1996; Lev-R-Vent Radiator Cap .....	10331	16	2011; OE Type Radiator Cap .....	10248	15
1996; OE Type Radiator Cap .....	10231	16	2011; OE Equivalent Fuel Cap .....	10841	
1996; OE Equivalent Fuel Cap .....	10817		2011; Flex Fuel Regular Fuel Cap .....	10841Y	
1996; Pre-Vent Non-Locking Fuel Cap .....	10819		2011; Regular Locking Fuel Cap .....	10511	
1996; Regular Locking Fuel Cap .....	10591		2011; Flex Fuel Regular Locking Fuel Cap .....	10511Y	
1996; Pre-Vent Locking Fuel Cap .....	10501		2010-2008; OE Type Radiator Cap .....	10248	15
1996; Oil Filler Cap .....	10099		2010-2008; OE Equivalent Fuel Cap .....	10841	
<b>V-6 3.8 L</b>			2010-2008; Regular Locking Fuel Cap .....	10511	
1995; Lev-R-Vent Radiator Cap .....	10331	16	2010-2008; Oil Filler Cap .....	10099	
1995; OE Type Radiator Cap .....	10231	16	<b>V-6 3.9 L</b>		
1995; OE Equivalent Fuel Cap .....	10817		2007-2006; OE Type Radiator Cap .....	10248	15
1995; Pre-Vent Non-Locking Fuel Cap .....	10819		2007-2006; OE Equivalent Fuel Cap .....	10841	
1995; Regular Locking Fuel Cap .....	10591		2007-2006; Regular Locking Fuel Cap .....	10511	
1995; Pre-Vent Locking Fuel Cap .....	10501		2007-2006; Oil Filler Cap .....	10099	
1995; Oil Filler Cap .....	10099		<b>Metro</b>		
<b>Malibu</b>			<b>3-Cyl. 1.0 L</b>		
<b>4-Cyl. 2.2 L</b>			2000-1998; OE Type Radiator Cap .....	10242	16
2008-2004; OE Type Radiator Cap .....	10248	15	2000-1998; OE Equivalent Fuel Cap .....	10825	
2008-2004; OE Equivalent Fuel Cap .....	10841		2000-1998; Regular Locking Fuel Cap .....	10595	
2008-2004; Regular Locking Fuel Cap .....	10511		2000-1998; Oil Filler Cap .....	10081	
2008-2004; Oil Filler Cap .....	10099		<b>4-Cyl. 1.3 L</b>		
<b>4-Cyl. 2.4 L</b>			2001-1998; OE Type Radiator Cap .....	10242	16
2011; OE Type Radiator Cap .....	10248	15	2001-1998; OE Equivalent Fuel Cap .....	10825	
2011; OE Equivalent Fuel Cap .....	10841		2001-1998; Regular Locking Fuel Cap .....	10595	
2011; Flex Fuel Regular Fuel Cap .....	10841Y		2001-1998; Oil Filler Cap .....	10081	
2011; Regular Locking Fuel Cap .....	10511		<b>Monte Carlo</b>		
2011; Flex Fuel Regular Locking Fuel Cap .....	10511Y		<b>V-6 3.1 L</b>		
2010; OE Type Radiator Cap .....	10248	15	1999-1997; Lev-R-Vent Radiator Cap .....	10331	16
2010; OE Equivalent Fuel Cap .....	10841		1999-1997; OE Type Radiator Cap .....	10231	16
2010; Flex Fuel Regular Fuel Cap .....	10841Y		1999-1997; OE Equivalent Fuel Cap .....	10836	
2010; Regular Locking Fuel Cap .....	10511		1999-1997; Regular Locking Fuel Cap .....	10506	
2010; Flex Fuel Regular Locking Fuel Cap .....	10511Y		1999-1997; Oil Filler Cap .....	10099	
2010; Oil Filler Cap .....	10099		1996-1995; Lev-R-Vent Radiator Cap .....	10331	16
2009-2008; OE Type Radiator Cap .....	10248	15	1996-1995; OE Type Radiator Cap .....	10231	16
2009-2008; OE Equivalent Fuel Cap .....	10841		1996-1995; OE Equivalent Fuel Cap .....	10817	
2009-2008; Regular Locking Fuel Cap .....	10511		1996-1995; Pre-Vent Non-Locking Fuel Cap .....	10819	
2009-2008; Oil Filler Cap .....	10099		1996-1995; Regular Locking Fuel Cap .....	10591	
1999; OE Type Radiator Cap .....	10248	15	1996-1995; Pre-Vent Locking Fuel Cap .....	10501	
1999; OE Equivalent Fuel Cap .....	10836		1996-1995; Oil Filler Cap .....	10099	
1999; Regular Locking Fuel Cap .....	10506		<b>V-6 3.4 L</b>		
1999; Oil Filler Cap .....	10105		2005-2004; OE Type Radiator Cap .....	10248	15
1998-1997; OE Type Radiator Cap .....	10239	15	2005-2004; OE Equivalent Fuel Cap .....	10836	
1998-1997; OE Equivalent Fuel Cap .....	10836		2005-2004; Regular Locking Fuel Cap .....	10506	
1998-1997; Regular Locking Fuel Cap .....	10506		2005-2004; Oil Filler Cap .....	10099	
1998-1997; Oil Filler Cap .....	10105		2003-2000; Lev-R-Vent Radiator Cap .....	10331	16
<b>4-Cyl. 2.4 L Electric Assist</b>			2003-2000; OE Type Radiator Cap .....	10231	16
2009-2008; OE Type Radiator Cap .....	10248	15	2003-2000; OE Equivalent Fuel Cap .....	10836	
2009-2008; OE Equivalent Fuel Cap .....	10841		2003-2000; Regular Locking Fuel Cap .....	10506	
2009-2008; Regular Locking Fuel Cap .....	10511		2003-2000; Oil Filler Cap .....	10099	
2009-2008; Oil Filler Cap .....	10099		1997; Lev-R-Vent Radiator Cap .....	10331	16
<b>V-6 3.1 L</b>			1997; OE Type Radiator Cap .....	10231	16
2003-1999; OE Type Radiator Cap .....	10248	15	1997; OE Equivalent Fuel Cap .....	10836	
2003-1999; OE Equivalent Fuel Cap .....	10836		1997; Regular Locking Fuel Cap .....	10506	
2003-1999; Regular Locking Fuel Cap .....	10506		1997; Oil Filler Cap .....	10119	
2003-1999; Oil Filler Cap .....	10099		1996-1995; Lev-R-Vent Radiator Cap .....	10331	16
1998-1997; OE Type Radiator Cap .....	10239	15	1996-1995; OE Type Radiator Cap .....	10231	16
1998-1997; OE Equivalent Fuel Cap .....	10836		1996-1995; OE Equivalent Fuel Cap .....	10817	
1998-1997; Regular Locking Fuel Cap .....	10506		1996-1995; Pre-Vent Non-Locking Fuel Cap .....	10819	
1998-1997; Oil Filler Cap .....	10099		1996-1995; Regular Locking Fuel Cap .....	10591	
<b>V-6 3.5 L</b>			1996-1995; Pre-Vent Locking Fuel Cap .....	10501	
2010; OE Type Radiator Cap .....	10248	15	1996-1995; Oil Filler Cap .....	10119	
2010; OE Equivalent Fuel Cap .....	10841		<b>V-6 3.5 L</b>		
2010; Flex Fuel Regular Fuel Cap .....	10841Y		2007; OE Equivalent Fuel Cap .....	10841	
2010; Regular Locking Fuel Cap .....	10511		2007; Flex Fuel Regular Fuel Cap .....	10841Y	
2010; Flex Fuel Regular Locking Fuel Cap .....	10511Y		2007; Regular Locking Fuel Cap .....	10511	
2010; Oil Filler Cap .....	10099		2007; Flex Fuel Regular Locking Fuel Cap .....	10511Y	
2009-2004; OE Type Radiator Cap .....	10248	15	2007; Oil Filler Cap .....	10099	
2009-2004; OE Equivalent Fuel Cap .....	10841		2006; OE Equivalent Fuel Cap .....	10841	
2009-2004; Regular Locking Fuel Cap .....	10511		2006; Regular Locking Fuel Cap .....	10511	
2009-2004; Oil Filler Cap .....	10099		2006; Oil Filler Cap .....	10099	

## Caps for Passenger Cars and Light Trucks (1990 and Newer)

Application	Part Number	PSI	Application	Part Number	PSI
<b>Chevrolet - Continued</b>			<b>Chevrolet - Continued</b>		
<b>Monte Carlo - Continued</b>			<b>P Series Van - Continued</b>		
<b>V-6 3.8 L</b>			<b>V-8 6.5 L Diesel - Continued</b>		
2005-2004: OE Type Radiator Cap .....	10248	15	1999-1998: Regular Locking Fuel Cap .....	10506	
2005-2004: OE Equivalent Fuel Cap .....	10836		1999-1998: Oil Filler Cap: Eng. VIN F .....	10066	
2005-2004: Regular Locking Fuel Cap .....	10506		1999-1998: Oil Filler Cap: Eng. VIN Y .....	10099	
2005-2004: Oil Filler Cap .....	10099		1997-1996: Lev-R-Vent Radiator Cap .....	10330	16
2003-1998: Lev-R-Vent Radiator Cap .....	10331	16	1997-1996: OE Type Radiator Cap .....	10230	16
2003-1998: OE Type Radiator Cap .....	10231	16	1997-1996: OE Equivalent Fuel Cap .....	10830	
2003-1998: OE Equivalent Fuel Cap .....	10836		1997-1996: Diesel Regular Non-Locking Fuel Cap .....	10830D	
2003-1998: Regular Locking Fuel Cap .....	10506		1997-1996: Pre-Vent Non-Locking Fuel Cap .....	10819	
2003-1998: Oil Filler Cap .....	10099		1997-1996: Diesel Pre-Vent Non-Locking Fuel Cap .....	10819D	
<b>V-6 3.9 L</b>			1997-1996: Regular Locking Fuel Cap .....	10591	
2006: OE Equivalent Fuel Cap .....	10841		1997-1996: Diesel Regular Locking Fuel Cap .....	10591D	
2006: Regular Locking Fuel Cap .....	10511		1997-1996: Pre-Vent Locking Fuel Cap .....	10501	
2006: Oil Filler Cap .....	10099		1997-1996: Diesel Only Pre-Vent Locking Fuel Cap .....	10501D	
<b>V-8 5.3 L</b>			1997-1996: Oil Filler Cap .....	10066	
2007-2006: OE Equivalent Fuel Cap .....	10841		1995: Lev-R-Vent Radiator Cap .....	10330	16
2007-2006: Regular Locking Fuel Cap .....	10511		1995: OE Type Radiator Cap .....	10230	16
2007-2006: Oil Filler Cap .....	10099		1995: OE Equivalent Fuel Cap .....	10817	
<b>Optra</b>			1995: Diesel Regular Non-Locking Fuel Cap .....	10830D	
<b>4-Cyl. 2.0 L (Canada)</b>			1995: Pre-Vent Non-Locking Fuel Cap .....	10819	
2007-2004: OE Equivalent Fuel Cap .....	10841		1995: Diesel Pre-Vent Non-Locking Fuel Cap .....	10819D	
2007-2004: Regular Locking Fuel Cap .....	10511		1995: Regular Locking Fuel Cap .....	10591	
2007-2004: Oil Filler Cap .....	10140		1995: Diesel Regular Locking Fuel Cap .....	10591D	
2007-2004: OE Equivalent Fuel Cap .....	10841		1995: Pre-Vent Locking Fuel Cap .....	10501	
2007-2004: Regular Locking Fuel Cap .....	10511		1995: Diesel Only Pre-Vent Locking Fuel Cap .....	10501D	
2007-2004: Oil Filler Cap .....	10140		1995: Oil Filler Cap .....	10066	
<b>P Series Van</b>			<b>V-8 7.4 L</b>		
<b>V-6 4.3 L</b>			1999: Lev-R-Vent Radiator Cap .....	10330	16
1999-1998: Lev-R-Vent Radiator Cap .....	10330	16	1999: OE Type Radiator Cap .....	10230	16
1999-1998: OE Type Radiator Cap .....	10230	16	1999: OE Equivalent Fuel Cap .....	10836	
1999-1998: OE Equivalent Fuel Cap .....	10836		1999: Regular Locking Fuel Cap .....	10506	
1999-1998: Regular Locking Fuel Cap .....	10506		1999: Oil Filler Cap .....	10114	
1999-1998: Oil Filler Cap .....	10114		1998: Lev-R-Vent Radiator Cap .....	10330	16
1997-1996: Lev-R-Vent Radiator Cap .....	10330	16	1998: OE Type Radiator Cap .....	10230	16
1997-1996: OE Type Radiator Cap .....	10230	16	1998: OE Equivalent Fuel Cap .....	10836	
1997-1996: OE Equivalent Fuel Cap .....	10817		1998: Regular Locking Fuel Cap .....	10506	
1997-1996: Pre-Vent Non-Locking Fuel Cap .....	10819		1998: Oil Filler Cap; Eng. VIN J .....	10114	
1997-1996: Regular Locking Fuel Cap .....	10591		1997-1996: Lev-R-Vent Radiator Cap .....	10330	16
1997-1996: Pre-Vent Locking Fuel Cap .....	10501		1997-1996: OE Type Radiator Cap .....	10230	16
1997-1996: Oil Filler Cap .....	10114		1997-1996: OE Equivalent Fuel Cap .....	10817	
1995: Lev-R-Vent Radiator Cap .....	10330	16	1997-1996: Pre-Vent Non-Locking Fuel Cap .....	10819	
1995: OE Type Radiator Cap .....	10230	16	1997-1996: Regular Locking Fuel Cap .....	10591	
1995: OE Equivalent Fuel Cap .....	10817		1997-1996: Pre-Vent Locking Fuel Cap .....	10501	
1995: Pre-Vent Non-Locking Fuel Cap .....	10819		1997-1996: Oil Filler Cap .....	10114	
1995: Regular Locking Fuel Cap .....	10591		1995: Lev-R-Vent Radiator Cap .....	10330	16
1995: Pre-Vent Locking Fuel Cap .....	10501		1995: OE Type Radiator Cap .....	10230	16
1995: Oil Filler Cap .....	10072		1995: OE Equivalent Fuel Cap .....	10817	
<b>V-8 5.7 L</b>			1995: Pre-Vent Non-Locking Fuel Cap .....	10819	
1999-1998: Lev-R-Vent Radiator Cap .....	10330	16	1995: Regular Locking Fuel Cap .....	10591	
1999-1998: OE Type Radiator Cap .....	10230	16	1995: Pre-Vent Locking Fuel Cap .....	10501	
1999-1998: OE Equivalent Fuel Cap .....	10836		1995: Oil Filler Cap .....	10105	
1999-1998: Regular Locking Fuel Cap .....	10506		<b>Prizm</b>		
1999-1998: Oil Filler Cap .....	10114		<b>4-Cyl. 1.8 L</b>		
1997-1996: Lev-R-Vent Radiator Cap .....	10330	16	2002-1998: OE Type Radiator Cap .....	10241	13
1997-1996: OE Type Radiator Cap .....	10230	16	2002-1998: OE Equivalent Fuel Cap .....	10825	
1997-1996: OE Equivalent Fuel Cap .....	10817		2002-1998: Regular Locking Fuel Cap .....	10595	
1997-1996: Pre-Vent Non-Locking Fuel Cap .....	10819		2002-1998: Oil Filler Cap .....	10080	
1997-1996: Regular Locking Fuel Cap .....	10591		<b>S Series Pickup</b>		
1997-1996: Pre-Vent Locking Fuel Cap .....	10501		<b>4-Cyl. 2.2 L</b>		
1997-1996: Oil Filler Cap .....	10114		2003-1998: Lev-R-Vent Radiator Cap .....	10330	16
1995: Lev-R-Vent Radiator Cap .....	10330	16	2003-1998: OE Type Radiator Cap .....	10230	16
1995: OE Type Radiator Cap .....	10230	16	2003-1998: OE Equivalent Fuel Cap .....	10836	
1995: OE Equivalent Fuel Cap .....	10817		2003-1998: Regular Locking Fuel Cap .....	10506	
1995: Pre-Vent Non-Locking Fuel Cap .....	10819		2003-1998: Oil Filler Cap .....	10125	
1995: Regular Locking Fuel Cap .....	10591		1997-1996: Lev-R-Vent Radiator Cap .....	10330	16
1995: Pre-Vent Locking Fuel Cap .....	10501		1997-1996: OE Type Radiator Cap .....	10230	16
1995: Oil Filler Cap .....	10066		1997-1996: OE Equivalent Fuel Cap .....	10836	
<b>V-8 6.5 L Diesel</b>			1997-1996: Regular Locking Fuel Cap .....	10506	
1999-1998: Lev-R-Vent Radiator Cap .....	10330	16	1997-1996: Oil Filler Cap .....	10128	
1999-1998: OE Type Radiator Cap .....	10230	16	1995: Lev-R-Vent Radiator Cap .....	10330	16
1999-1998: OE Equivalent Fuel Cap .....	10836		1995: OE Type Radiator Cap .....	10230	16
			1995: OE Equivalent Fuel Cap .....	10817	

## Caps for Passenger Cars and Light Trucks (1990 and Newer)

Application	Part Number	PSI	Application	Part Number	PSI
<b>Chevrolet - Continued</b>			<b>Chevrolet - Continued</b>		
<b>S Series Pickup - Continued</b>			<b>Silverado Series Pickup - Continued</b>		
<b>4-Cyl. 2.2 L - Continued</b>			<b>V-8 5.3 L - Continued</b>		
1995; Pre-Vent Non-Locking Fuel Cap .....	10819		2004; Flex Fuel Regular Fuel Cap; W/O Threaded Filler Neck ...	10841Y	
1995; Regular Locking Fuel Cap .....	10591		2004; Regular Locking Fuel Cap; W/O Threaded Filler Neck .....	10511	
1995; Pre-Vent Locking Fuel Cap .....	10501		2004; Flex Fuel Regular Locking Fuel Cap; W/O Threaded Filler Neck .....	10511Y	
1995; Oil Filler Cap .....	10128		2004; Oil Filler Cap .....	10099	
<b>V-6 4.3 L</b>			2003-2002; OE Type Radiator Cap .....	10248	15
2004-1996; Lev-R-Vent Radiator Cap .....	10330	16	2003-2002; OE Equivalent Fuel Cap .....	10834	
2004-1996; OE Type Radiator Cap .....	10230	16	2003-2002; Flex Fuel Regular Fuel Cap .....	10834Y	
2004-1996; OE Equivalent Fuel Cap .....	10836		2003-2002; Regular Locking Fuel Cap .....	10504	
2004-1996; Regular Locking Fuel Cap .....	10506		2003-2002; Flex Fuel Regular Locking Fuel Cap .....	10504Y	
2004-1996; Oil Filler Cap .....	10099		2003-2002; Oil Filler Cap .....	10099	
1995; Lev-R-Vent Radiator Cap .....	10330	16	2001-1999; OE Type Radiator Cap .....	10248	15
1995; OE Type Radiator Cap .....	10230	16	2001-1999; OE Equivalent Fuel Cap .....	10834	
1995; OE Equivalent Fuel Cap .....	10817		2001-1999; Regular Locking Fuel Cap .....	10504	
1995; Pre-Vent Non-Locking Fuel Cap .....	10819		2001-1999; Oil Filler Cap .....	10099	
1995; Regular Locking Fuel Cap .....	10591		<b>V-8 5.3 L Electric Assist</b>		
1995; Pre-Vent Locking Fuel Cap .....	10501		2007-2004; OE Type Radiator Cap .....	10248	15
1995; Oil Filler Cap .....	10099		2007-2004; OE Equivalent Fuel Cap .....	10841	
<b>Silverado Series Pickup</b>			2007-2004; Regular Locking Fuel Cap .....	10511	
<b>V-6 4.3 L</b>			2007-2004; Oil Filler Cap .....	10099	
2011; OE Equivalent Fuel Cap .....	10841		<b>V-8 6.0 L</b>		
2011; Regular Locking Fuel Cap .....	10511		2011; OE Type Radiator Cap .....	10248	15
2011; Oil Filler Cap .....	10099		2011; OE Equivalent Fuel Cap; 2500, 3500 .....	10834	
2010-2005; OE Type Radiator Cap .....	10248	15	2011; Regular Locking Fuel Cap; 2500, 3500 .....	10504	
2010-2005; OE Equivalent Fuel Cap .....	10841		2011; Oil Filler Cap .....	10099	
2010-2005; Regular Locking Fuel Cap .....	10511		2010; OE Type Radiator Cap .....	10248	15
2010-2005; Oil Filler Cap .....	10099		2010; OE Equivalent Fuel Cap; W/O Threaded Filler Neck .....	10841	
2004; OE Type Radiator Cap .....	10248	15	2010; Flex Fuel Regular Fuel Cap; W/O Threaded Filler Neck ...	10841Y	
2004; OE Equivalent Fuel Cap; W/Threaded Filler Neck .....	10834		2010; Regular Locking Fuel Cap; W/O Threaded Filler Neck .....	10511	
2004; Regular Locking Fuel Cap; W/Threaded Filler Neck .....	10504		2010; Flex Fuel Regular Locking Fuel Cap; W/O Threaded Filler Neck .....	10511Y	
2004; OE Equivalent Fuel Cap; W/O Threaded Filler Neck .....	10841		2010; OE Equivalent Fuel Cap; W/Threaded Filler Neck .....	10834	
2004; Regular Locking Fuel Cap; W/O Threaded Filler Neck .....	10511		2010; Regular Locking Fuel Cap; W/Threaded Filler Neck .....	10504	
2004; Oil Filler Cap .....	10099		2010; Oil Filler Cap .....	10099	
2003-1999; OE Type Radiator Cap .....	10248	15	2010; OE Equivalent Fuel Cap .....	10841	
2003-1999; OE Equivalent Fuel Cap .....	10834		2009; Regular Locking Fuel Cap .....	10511	
2003-1999; Regular Locking Fuel Cap .....	10504		2009; Oil Filler Cap .....	10099	
2003-1999; Oil Filler Cap .....	10099		2008; OE Type Radiator Cap .....	10248	15
<b>V-8 4.8 L</b>			2008; OE Equivalent Fuel Cap .....	10841	
2011-2010; OE Type Radiator Cap .....	10248	15	2008; Regular Locking Fuel Cap .....	10511	
2011-2010; OE Equivalent Fuel Cap .....	10841		2008; Oil Filler Cap .....	10099	
2011-2010; Flex Fuel Regular Fuel Cap .....	10841Y		2007-2005; OE Type Radiator Cap .....	10248	15
2011-2010; Regular Locking Fuel Cap .....	10511		2007-2005; OE Equivalent Fuel Cap; W/O Threaded Filler Neck .....	10841	
2011-2010; Flex Fuel Regular Locking Fuel Cap .....	10511Y		2007-2005; Regular Locking Fuel Cap; W/O Threaded Filler Neck .....	10511	
2011-2010; Oil Filler Cap .....	10099		2007-2005; OE Equivalent Fuel Cap; W/Threaded Filler Neck ...	10834	
2009-2005; OE Type Radiator Cap .....	10248	15	2007-2005; Regular Locking Fuel Cap; W/Threaded Filler Neck .....	10504	
2009-2005; OE Equivalent Fuel Cap .....	10841		2007-2005; Oil Filler Cap .....	10099	
2009-2005; Regular Locking Fuel Cap .....	10511		2004; OE Type Radiator Cap .....	10248	15
2009-2005; Oil Filler Cap .....	10099		2004; OE Equivalent Fuel Cap; W/Threaded Filler Neck .....	10834	
2004; OE Type Radiator Cap .....	10248	15	2004; Regular Locking Fuel Cap; W/Threaded Filler Neck .....	10504	
2004; OE Equivalent Fuel Cap; W/Threaded Filler Neck .....	10834		2004; OE Equivalent Fuel Cap; W/O Threaded Filler Neck .....	10841	
2004; Regular Locking Fuel Cap; W/Threaded Filler Neck .....	10504		2004; Regular Locking Fuel Cap; W/O Threaded Filler Neck .....	10511	
2004; OE Equivalent Fuel Cap; W/O Threaded Filler Neck .....	10841		2004; Oil Filler Cap .....	10099	
2004; Regular Locking Fuel Cap; W/O Threaded Filler Neck .....	10511		2003-1999; OE Type Radiator Cap .....	10248	15
2004; Oil Filler Cap .....	10099		2003-1999; OE Equivalent Fuel Cap .....	10834	
2003-1999; OE Type Radiator Cap .....	10248	15	2003-1999; Regular Locking Fuel Cap .....	10504	
2003-1999; OE Equivalent Fuel Cap .....	10834		2003-1999; Oil Filler Cap .....	10099	
2003-1999; Regular Locking Fuel Cap .....	10504		<b>V-8 5.3 L</b>		
2003-1999; Oil Filler Cap .....	10099		2011-2005; OE Type Radiator Cap .....	10248	15
<b>V-8 5.3 L</b>			2011-2005; OE Equivalent Fuel Cap .....	10841	
2011-2005; OE Type Radiator Cap .....	10248	15	2011-2005; Flex Fuel Regular Fuel Cap .....	10841Y	
2011-2005; OE Equivalent Fuel Cap .....	10841		2011-2005; Regular Locking Fuel Cap .....	10511	
2011-2005; Flex Fuel Regular Fuel Cap .....	10841Y		2011-2005; Flex Fuel Regular Locking Fuel Cap .....	10511Y	
2011-2005; Regular Locking Fuel Cap .....	10511		2011-2005; Oil Filler Cap .....	10099	
2011-2005; Flex Fuel Regular Locking Fuel Cap .....	10511Y		2004; OE Type Radiator Cap .....	10248	15
2011-2005; Oil Filler Cap .....	10099		2004; OE Equivalent Fuel Cap; W/Threaded Filler Neck .....	10834	
2004; OE Type Radiator Cap .....	10248	15	2004; Flex Fuel Regular Fuel Cap; W/Threaded Filler Neck .....	10834Y	
2004; OE Equivalent Fuel Cap; W/Threaded Filler Neck .....	10834		2004; Regular Locking Fuel Cap; W/Threaded Filler Neck .....	10504	
2004; Flex Fuel Regular Fuel Cap; W/Threaded Filler Neck .....	10834Y		2004; Flex Fuel Regular Locking Fuel Cap; W/Threaded Filler Neck .....	10504Y	
2004; Regular Locking Fuel Cap; W/Threaded Filler Neck .....	10504		2004; OE Equivalent Fuel Cap; W/O Threaded Filler Neck .....	10841	
2004; Flex Fuel Regular Locking Fuel Cap; W/Threaded Filler Neck .....	10504Y		2004; Regular Locking Fuel Cap; W/O Threaded Filler Neck .....	10511	
2004; OE Equivalent Fuel Cap; W/O Threaded Filler Neck .....	10841		2004; Oil Filler Cap .....	10099	
			2003-1999; OE Type Radiator Cap .....	10248	15
			2003-1999; OE Equivalent Fuel Cap .....	10834	
			2003-1999; Regular Locking Fuel Cap .....	10504	
			2003-1999; Oil Filler Cap .....	10099	
			<b>V-8 6.0 L Electric Assist</b>		
			2010-2009; OE Type Radiator Cap .....	10248	15
			2010-2009; OE Equivalent Fuel Cap .....	10841	
			2010-2009; Regular Locking Fuel Cap .....	10511	
			2010-2009; Oil Filler Cap .....	10099	
			<b>V-8 6.2 L</b>		
			2011; OE Equivalent Fuel Cap .....	10841	
			2011; Flex Fuel Regular Fuel Cap .....	10841Y	
			2011; Regular Locking Fuel Cap .....	10511	
			2011; Flex Fuel Regular Locking Fuel Cap .....	10511Y	
			2011; Oil Filler Cap .....	10099	
			2010; OE Type Radiator Cap .....	10248	15
			2010; OE Equivalent Fuel Cap .....	10841	
			2010; Flex Fuel Regular Fuel Cap .....	10841Y	

## Caps for Passenger Cars and Light Trucks (1990 and Newer)

Application	Part Number	PSI	Application	Part Number	PSI
<b>Chevrolet - Continued</b>			<b>Chevrolet - Continued</b>		
<b>Silverado Series Pickup - Continued</b>			<b>SSR - Continued</b>		
<b>V-8 6.2 L - Continued</b>			<b>V-8 6.0 L - Continued</b>		
2010; Regular Locking Fuel Cap .....	10511		2006-2005; Regular Locking Fuel Cap .....	10511	
2010; Flex Fuel Regular Locking Fuel Cap .....	10511Y		2006-2005; Oil Filler Cap .....	10099	
2010; Oil Filler Cap .....	10099		<b>Suburban</b>		
2009; OE Type Radiator Cap .....	10248	15	<b>V-8 5.3 L</b>		
2009; OE Equivalent Fuel Cap .....	10841		2011-2009; OE Type Radiator Cap .....	10248	15
2009; Regular Locking Fuel Cap .....	10511		2011-2009; OE Equivalent Fuel Cap .....	10841	
2009; Oil Filler Cap .....	10099		2011-2009; Flex Fuel Regular Fuel Cap .....	10841Y	
<b>V-8 6.5 L Diesel</b>			2011-2009; Regular Locking Fuel Cap .....	10511	
1999; Oil Filler Cap .....	10099		2011-2009; Flex Fuel Regular Locking Fuel Cap .....	10511Y	
<b>V-8 6.6 L Diesel</b>			2011-2009; Oil Filler Cap .....	10099	
2011; OE Equivalent Fuel Cap .....	10830		2008; OE Type Radiator Cap .....	10248	15
2011; Regular Locking Fuel Cap .....	10591		2008; OE Equivalent Fuel Cap .....	10841	
2011; Diesel Regular Non-Locking Fuel Cap .....	10830D		2008; Regular Locking Fuel Cap .....	10511	
2011; Diesel Regular Locking Fuel Cap .....	10591D		2008; Flex Fuel Regular Fuel Cap .....	10841Y	
2011; Oil Filler Cap .....	10099		2008; Flex Fuel Regular Locking Fuel Cap .....	10511Y	
2010-2003; OE Type Radiator Cap .....	10248	15	2008; Oil Filler Cap .....	10099	
2010-2003; OE Equivalent Fuel Cap .....	10830		2007-2005; OE Type Radiator Cap .....	10248	15
2010-2003; Diesel Regular Non-Locking Fuel Cap .....	10830D		2007-2005; OE Equivalent Fuel Cap .....	10841	
2010-2003; Regular Locking Fuel Cap .....	10591		2007-2005; Flex Fuel Regular Fuel Cap .....	10841Y	
2010-2003; Diesel Regular Locking Fuel Cap .....	10591D		2007-2005; Regular Locking Fuel Cap .....	10511	
2010-2003; Oil Filler Cap .....	10099		2007-2005; Flex Fuel Regular Locking Fuel Cap .....	10511Y	
2002; OE Type Radiator Cap .....	10248	15	2007-2005; Oil Filler Cap .....	10099	
2002; OE Equivalent Fuel Cap; W/O Stripped Chassis .....	10830		2004; OE Type Radiator Cap .....	10248	15
2002; Diesel Regular Non-Locking Fuel Cap; W/O Stripped Chassis .....	10830D		2004; OE Equivalent Fuel Cap; W/Threaded Filler Neck .....	10834	
2002; Regular Locking Fuel Cap; W/O Stripped Chassis .....	10591		2004; Flex Fuel Regular Fuel Cap; W/Threaded Filler Neck .....	10834Y	
2002; Diesel Regular Locking Fuel Cap; W/O Stripped Chassis .....	10591D		2004; Regular Locking Fuel Cap; W/Threaded Filler Neck .....	10504	
2002; Oil Filler Cap .....	10099		2004; Flex Fuel Regular Locking Fuel Cap; W/Threaded Filler Neck .....	10504Y	
2001; OE Type Radiator Cap .....	10248	15	2004; OE Equivalent Fuel Cap; W/O Threaded Filler Neck .....	10841	
2001; OE Equivalent Fuel Cap .....	10830		2004; Flex Fuel Regular Fuel Cap; W/O Threaded Filler Neck ...	10841Y	
2001; Diesel Regular Non-Locking Fuel Cap .....	10830D		2004; Regular Locking Fuel Cap; W/O Threaded Filler Neck .....	10511	
2001; Regular Locking Fuel Cap .....	10591		2004; Flex Fuel Regular Locking Fuel Cap; W/O Threaded Filler Neck .....	10511Y	
2001; Diesel Regular Locking Fuel Cap .....	10591D		2004; Oil Filler Cap .....	10099	
2001; Oil Filler Cap .....	10099		2003-2002; OE Type Radiator Cap .....	10248	15
<b>V-8 8.1 L</b>			2003-2002; OE Equivalent Fuel Cap .....	10834	
2007-2006; OE Type Radiator Cap .....	10248	15	2003-2002; Flex Fuel Regular Fuel Cap .....	10834Y	
2007-2006; OE Equivalent Fuel Cap; W/O Threaded Filler Neck .....	10841		2003-2002; Regular Locking Fuel Cap .....	10504	
2007-2006; Regular Locking Fuel Cap; W/O Threaded Filler Neck .....	10511		2003-2002; Flex Fuel Regular Locking Fuel Cap .....	10504Y	
2007-2006; OE Equivalent Fuel Cap; W/Threaded Filler Neck ...	10834		2003-2002; Oil Filler Cap .....	10099	
2007-2006; Regular Locking Fuel Cap; W/Threaded Filler Neck .....	10504		2001-2000; OE Type Radiator Cap .....	10248	15
2007-2006; Oil Filler Cap .....	10099		2001-2000; OE Equivalent Fuel Cap .....	10834	
2005; OE Type Radiator Cap .....	10248	15	2001-2000; Regular Locking Fuel Cap .....	10504	
2005; OE Equivalent Fuel Cap; W/O Threaded Fuel Cap .....	10841		2001-2000; Oil Filler Cap .....	10099	
2005; Regular Locking Fuel Cap; W/O Threaded Fuel Cap .....	10511		<b>V-8 5.7 L</b>		
2005; OE Equivalent Fuel Cap; W/Threaded Fuel Cap .....	10834		1999; OE Type Radiator Cap .....	10248	15
2005; Regular Locking Fuel Cap; W/Threaded Fuel Cap .....	10504		1999; OE Equivalent Fuel Cap .....	10834	
2005; Oil Filler Cap .....	10099		1999; Regular Locking Fuel Cap .....	10504	
2004; OE Type Radiator Cap .....	10248	15	1999; Oil Filler Cap .....	10105	
2004; OE Equivalent Fuel Cap; W/Threaded Filler Neck .....	10834		1998; Lev-R-Vent Radiator Cap .....	10331	16
2004; Regular Locking Fuel Cap; W/Threaded Filler Neck .....	10504		1998; OE Type Radiator Cap .....	10231	16
2004; OE Equivalent Fuel Cap; W/O Threaded Filler Neck .....	10841		1998; OE Equivalent Fuel Cap .....	10834	
2004; Regular Locking Fuel Cap; W/O Threaded Filler Neck .....	10511		1998; Regular Locking Fuel Cap .....	10504	
2004; Oil Filler Cap .....	10099		1998; Oil Filler Cap .....	10105	
2003; OE Type Radiator Cap .....	10248	15	1997-1995; Lev-R-Vent Radiator Cap .....	10331	16
2003; OE Equivalent Fuel Cap .....	10834		1997-1995; OE Type Radiator Cap .....	10231	16
2003; Regular Locking Fuel Cap .....	10504		1997-1995; OE Equivalent Fuel Cap .....	10817	
2003; Oil Filler Cap .....	10099		1997-1995; Pre-Vent Non-Locking Fuel Cap .....	10819	
2002-2001; OE Type Radiator Cap .....	10248	15	1997-1995; Regular Locking Fuel Cap .....	10591	
2002-2001; OE Equivalent Fuel Cap .....	10834		1997-1995; Pre-Vent Locking Fuel Cap .....	10501	
2002-2001; Regular Locking Fuel Cap .....	10504		1997-1995; Oil Filler Cap .....	10105	
2002-2001; Oil Filler Cap .....	10114		<b>V-8 6.0 L</b>		
<b>SSR</b>			2011; OE Equivalent Fuel Cap .....	10841	
<b>V-8 5.3 L</b>			2011; Flex Fuel Regular Fuel Cap .....	10841Y	
2004-2003; OE Type Radiator Cap .....	10248	15	2011; Regular Locking Fuel Cap .....	10511	
2004-2003; OE Equivalent Fuel Cap .....	10836		2011; Flex Fuel Regular Locking Fuel Cap .....	10511Y	
2004-2003; Regular Locking Fuel Cap .....	10506		2011; Oil Filler Cap .....	10099	
2004-2003; Oil Filler Cap .....	10099		2010; OE Type Radiator Cap .....	10248	15
<b>V-8 6.0 L</b>			2010; OE Equivalent Fuel Cap .....	10841	
2006-2005; OE Type Radiator Cap .....	10248	15	2010; Flex Fuel Regular Fuel Cap .....	10841Y	
2006-2005; OE Equivalent Fuel Cap .....	10841		2010; Regular Locking Fuel Cap .....	10511	

## Caps for Passenger Cars and Light Trucks (1990 and Newer)

Application	Part Number	PSI	Application	Part Number	PSI
<b>Chevrolet - Continued</b>			<b>Chevrolet - Continued</b>		
<b>Suburban - Continued</b>			<b>Suburban - Continued</b>		
<b>V-8 6.0 L - Continued</b>			<b>V-8 7.4 L - Continued</b>		
2010; Flex Fuel Regular Locking Fuel Cap .....	10511Y		1995; Regular Locking Fuel Cap .....	10591	
2010; Oil Filler Cap .....	10099		1995; Pre-Vent Locking Fuel Cap .....	10501	
2009-2005; OE Type Radiator Cap .....	10248	15	1995; Oil Filler Cap .....	10105	
2009-2005; OE Equivalent Fuel Cap .....	10841		<b>V-8 8.1 L</b>		
2009-2005; Regular Locking Fuel Cap .....	10511		2006-2005; OE Type Radiator Cap .....	10248	15
2009-2005; Oil Filler Cap .....	10099		2006-2005; OE Equivalent Fuel Cap .....	10841	
2004; OE Type Radiator Cap .....	10248	15	2006-2005; Regular Locking Fuel Cap .....	10511	
2004; OE Equivalent Fuel Cap; W/Threaded Filler Neck .....	10834		2006-2005; Oil Filler Cap .....	10099	
2004; Regular Locking Fuel Cap; W/Threaded Filler Neck .....	10504		2004; OE Type Radiator Cap .....	10248	15
2004; OE Equivalent Fuel Cap; W/O Threaded Filler Neck .....	10841		2004; OE Equivalent Fuel Cap; W/Threaded Filler Neck .....	10834	
2004; Regular Locking Fuel Cap; W/O Threaded Filler Neck .....	10511		2004; Regular Locking Fuel Cap; W/Threaded Filler Neck .....	10504	
2004; Oil Filler Cap .....	10099		2004; OE Equivalent Fuel Cap; W/O Threaded Filler Neck .....	10841	
2003-2000; OE Type Radiator Cap .....	10248	15	2004; Regular Locking Fuel Cap; W/O Threaded Filler Neck .....	10511	
2003-2000; OE Equivalent Fuel Cap .....	10834		2004; Oil Filler Cap .....	10099	
2003-2000; Regular Locking Fuel Cap .....	10504		2003; OE Type Radiator Cap .....	10248	15
2003-2000; Oil Filler Cap .....	10099		2003; OE Equivalent Fuel Cap .....	10834	
<b>V-8 6.5 L Diesel</b>			2003; Regular Locking Fuel Cap .....	10504	
1999-1998; Lev-R-Vent Radiator Cap .....	10330	16	2003; Oil Filler Cap .....	10099	
1999-1998; OE Type Radiator Cap .....	10230	16	2002-2001; OE Type Radiator Cap .....	10248	15
1999-1998; OE Equivalent Fuel Cap .....	10817		2002-2001; OE Equivalent Fuel Cap .....	10834	
1999-1998; Diesel Regular Non-Locking Fuel Cap .....	10830D		2002-2001; Regular Locking Fuel Cap .....	10504	
1999-1998; Pre-Vent Non-Locking Fuel Cap .....	10819		2002-2001; Oil Filler Cap .....	10114	
1999-1998; Diesel Pre-Vent Non-Locking Fuel Cap .....	10819D		<b>Tahoe</b>		
1999-1998; Regular Locking Fuel Cap .....	10591		<b>V-8 4.8 L</b>		
1999-1998; Diesel Regular Locking Fuel Cap .....	10591D		2009-2005; OE Type Radiator Cap .....	10248	15
1999-1998; Pre-Vent Locking Fuel Cap .....	10501		2009-2005; OE Equivalent Fuel Cap .....	10841	
1999-1998; Diesel Only Pre-Vent Locking Fuel Cap .....	10501D		2009-2005; Regular Locking Fuel Cap .....	10511	
1999-1998; Oil Filler Cap .....	10099		2009-2005; Oil Filler Cap .....	10099	
1997; Lev-R-Vent Radiator Cap .....	10330	16	2004; OE Type Radiator Cap .....	10248	15
1997; OE Type Radiator Cap .....	10230	16	2004; OE Equivalent Fuel Cap; W/Threaded Filler Neck .....	10834	
1997; OE Equivalent Fuel Cap .....	10817		2004; Regular Locking Fuel Cap; W/Threaded Filler Neck .....	10504	
1997; Diesel Regular Non-Locking Fuel Cap .....	10830D		2004; OE Equivalent Fuel Cap; W/O Threaded Filler Neck .....	10841	
1997; Pre-Vent Non-Locking Fuel Cap .....	10819		2004; Regular Locking Fuel Cap; W/O Threaded Filler Neck .....	10511	
1997; Diesel Pre-Vent Non-Locking Fuel Cap .....	10819D		2004; Oil Filler Cap .....	10099	
1997; Regular Locking Fuel Cap .....	10591		2003-2000; OE Type Radiator Cap .....	10248	15
1997; Diesel Regular Locking Fuel Cap .....	10591D		2003-2000; OE Equivalent Fuel Cap .....	10834	
1997; Pre-Vent Locking Fuel Cap .....	10501		2003-2000; Regular Locking Fuel Cap .....	10504	
1997; Diesel Only Pre-Vent Locking Fuel Cap .....	10501D		2003-2000; Oil Filler Cap .....	10099	
1997; Oil Filler Cap; W/Metal Oil Cap .....	10066		<b>V-8 5.3 L</b>		
1997; Oil Filler Cap; W/O Metal Oil Cap .....	10099		2011; OE Equivalent Fuel Cap .....	10841	
1996-1995; Lev-R-Vent Radiator Cap .....	10330	16	2011; Flex Fuel Regular Fuel Cap .....	10841Y	
1996-1995; OE Type Radiator Cap .....	10230	16	2011; Regular Locking Fuel Cap .....	10511	
1996-1995; OE Equivalent Fuel Cap .....	10817		2011; Flex Fuel Regular Locking Fuel Cap .....	10511Y	
1996-1995; Diesel Regular Non-Locking Fuel Cap .....	10830D		2011; Oil Filler Cap .....	10099	
1996-1995; Pre-Vent Non-Locking Fuel Cap .....	10819		2010-2009; OE Type Radiator Cap .....	10248	15
1996-1995; Diesel Pre-Vent Non-Locking Fuel Cap .....	10819D		2010-2009; OE Equivalent Fuel Cap .....	10841	
1996-1995; Regular Locking Fuel Cap .....	10591		2010-2009; Flex Fuel Regular Fuel Cap .....	10841Y	
1996-1995; Diesel Regular Locking Fuel Cap .....	10591D		2010-2009; Regular Locking Fuel Cap .....	10511	
1996-1995; Pre-Vent Locking Fuel Cap .....	10501		2010-2009; Flex Fuel Regular Locking Fuel Cap .....	10511Y	
1996-1995; Diesel Only Pre-Vent Locking Fuel Cap .....	10501D		2010-2009; Oil Filler Cap .....	10099	
1996-1995; Oil Filler Cap .....	10066		2008; OE Type Radiator Cap .....	10248	15
<b>V-8 7.4 L</b>			2008; OE Equivalent Fuel Cap .....	10841	
1999; OE Type Radiator Cap .....	10248	15	2008; Regular Locking Fuel Cap .....	10511	
1999; OE Equivalent Fuel Cap .....	10834		2008; Flex Fuel Regular Fuel Cap .....	10841Y	
1999; Regular Locking Fuel Cap .....	10504		2008; Flex Fuel Regular Locking Fuel Cap .....	10511Y	
1999; Oil Filler Cap .....	10114		2008; Oil Filler Cap .....	10099	
1998; Lev-R-Vent Radiator Cap .....	10331	16	2007-2005; OE Type Radiator Cap .....	10248	15
1998; OE Type Radiator Cap .....	10231	16	2007-2005; OE Equivalent Fuel Cap .....	10841	
1998; OE Equivalent Fuel Cap .....	10834		2007-2005; Flex Fuel Regular Fuel Cap .....	10841Y	
1998; Regular Locking Fuel Cap .....	10504		2007-2005; Regular Locking Fuel Cap .....	10511	
1998; Oil Filler Cap .....	10114		2007-2005; Flex Fuel Regular Locking Fuel Cap .....	10511Y	
1997-1996; Lev-R-Vent Radiator Cap .....	10331	16	2007-2005; Oil Filler Cap .....	10099	
1997-1996; OE Type Radiator Cap .....	10231	16	2004; OE Type Radiator Cap .....	10248	15
1997-1996; OE Equivalent Fuel Cap .....	10817		2004; OE Equivalent Fuel Cap; W/Threaded Filler Neck .....	10834	
1997-1996; Pre-Vent Non-Locking Fuel Cap .....	10819		2004; Flex Fuel Regular Fuel Cap; W/Threaded Filler Neck .....	10834Y	
1997-1996; Regular Locking Fuel Cap .....	10591		2004; Regular Locking Fuel Cap; W/Threaded Filler Neck .....	10504	
1997-1996; Pre-Vent Locking Fuel Cap .....	10501		2004; Flex Fuel Regular Locking Fuel Cap; W/Threaded Filler Neck .....	10504Y	
1997-1996; Oil Filler Cap .....	10114		2004; OE Equivalent Fuel Cap; W/O Threaded Filler Neck .....	10841	
1995; Lev-R-Vent Radiator Cap .....	10331	16	2004; Flex Fuel Regular Fuel Cap; W/O Threaded Filler Neck .....	10841Y	
1995; OE Type Radiator Cap .....	10231	16	2004; Regular Locking Fuel Cap; W/O Threaded Filler Neck .....	10511	
1995; OE Equivalent Fuel Cap .....	10817				
1995; Pre-Vent Non-Locking Fuel Cap .....	10819				

## Caps for Passenger Cars and Light Trucks (1990 and Newer)

Application	Part Number	PSI	Application	Part Number	PSI
<b>Chevrolet - Continued</b>			<b>Chevrolet - Continued</b>		
<b>Tahoe - Continued</b>			<b>Tracker</b>		
<b>V-8 5.3 L - Continued</b>			<b>4-Cyl. 1.6 L</b>		
2004; Flex Fuel Regular Locking Fuel Cap; W/O Threaded Filler Neck .....	10511Y		2000-1998; OE Type Radiator Cap .....	10242	16
2004; Oil Filler Cap .....	10099		2000-1998; OE Equivalent Fuel Cap .....	10825	
2003-2002; OE Type Radiator Cap .....	10248	15	2000-1998; Regular Locking Fuel Cap .....	10595	
2003-2002; OE Equivalent Fuel Cap .....	10834		2000-1998; Oil Filler Cap .....	10081	
2003-2002; Flex Fuel Regular Fuel Cap .....	10834Y		<b>4-Cyl. 1.6 L (Canada)</b>		
2003-2002; Regular Locking Fuel Cap .....	10504		2002-2001; OE Type Radiator Cap .....	10242	16
2003-2002; Flex Fuel Regular Locking Fuel Cap .....	10504Y		2002-2001; OE Equivalent Fuel Cap .....	10825	
2003-2002; Oil Filler Cap .....	10099		2002-2001; Regular Locking Fuel Cap .....	10595	
2001-2000; OE Type Radiator Cap .....	10248	15	2002-2001; Oil Filler Cap .....	10081	
2001-2000; OE Equivalent Fuel Cap .....	10834		<b>4-Cyl. 2.0 L</b>		
2001-2000; Regular Locking Fuel Cap .....	10504		2003-1999; OE Type Radiator Cap .....	10242	16
2001-2000; Oil Filler Cap .....	10099		2003-1999; OE Equivalent Fuel Cap .....	10825	
<b>V-8 5.7 L</b>			2003-1999; Regular Locking Fuel Cap .....	10595	
2000-1998; Lev-R-Vent Radiator Cap .....	10331	16	2003-1999; Oil Filler Cap .....	10081	
2000-1998; OE Type Radiator Cap .....	10231	16	<b>V-6 2.5 L</b>		
2000-1998; OE Equivalent Fuel Cap .....	10834		2004-2001; OE Type Radiator Cap .....	10242	16
2000-1998; Regular Locking Fuel Cap .....	10504		2004-2001; OE Equivalent Fuel Cap .....	10825	
2000-1998; Oil Filler Cap .....	10105		2004-2001; Regular Locking Fuel Cap .....	10595	
1997-1995; Lev-R-Vent Radiator Cap .....	10331	16	2004-2001; Oil Filler Cap .....	10081	
1997-1995; OE Type Radiator Cap .....	10231	16	<b>Trailblazer</b>		
1997-1995; OE Equivalent Fuel Cap .....	10817		<b>6-Cyl. 4.2 L</b>		
1997-1995; Pre-Vent Non-Locking Fuel Cap .....	10819		2009-2005; OE Type Radiator Cap .....	10248	15
1997-1995; Regular Locking Fuel Cap .....	10591		2009-2005; OE Equivalent Fuel Cap .....	10841	
1997-1995; Pre-Vent Locking Fuel Cap .....	10501		2009-2005; Regular Locking Fuel Cap .....	10511	
1997-1995; Oil Filler Cap .....	10105		2009-2005; Oil Filler Cap .....	10099	
<b>V-8 6.0 L Electric Assist</b>			2004-2002; OE Type Radiator Cap .....	10248	15
2011; OE Equivalent Fuel Cap .....	10841		2004-2002; OE Equivalent Fuel Cap .....	10836	
2011; Flex Fuel Regular Fuel Cap .....	10841Y		2004-2002; Regular Locking Fuel Cap .....	10506	
2011; Regular Locking Fuel Cap .....	10511		2004-2002; Oil Filler Cap .....	10099	
2011; Flex Fuel Regular Locking Fuel Cap .....	10511Y		<b>V-8 5.3 L</b>		
2011; Oil Filler Cap .....	10099		2008-2005; OE Type Radiator Cap .....	10248	15
2010; Oil Filler Cap .....	10099		2008-2005; OE Equivalent Fuel Cap .....	10841	
2009-2008; OE Type Radiator Cap .....	10248	15	2008-2005; Regular Locking Fuel Cap .....	10511	
2009-2008; OE Equivalent Fuel Cap .....	10841		2008-2005; Oil Filler Cap .....	10099	
2009-2008; Regular Locking Fuel Cap .....	10511		2004-2003; OE Type Radiator Cap .....	10248	15
2009-2008; Oil Filler Cap .....	10099		2004-2003; OE Equivalent Fuel Cap .....	10836	
<b>V-8 6.2 L</b>			2004-2003; Regular Locking Fuel Cap .....	10506	
2009-2008; OE Type Radiator Cap .....	10248	15	2004-2003; Oil Filler Cap .....	10099	
2009-2008; OE Equivalent Fuel Cap .....	10841		<b>V-8 6.0 L</b>		
2009-2008; Regular Locking Fuel Cap .....	10511		2009-2006; OE Type Radiator Cap .....	10248	15
2009-2008; Oil Filler Cap .....	10099		2009-2006; OE Equivalent Fuel Cap .....	10841	
<b>V-8 6.5 L Diesel</b>			2009-2006; Regular Locking Fuel Cap .....	10511	
1999-1998; Lev-R-Vent Radiator Cap .....	10330	16	2009-2006; Oil Filler Cap .....	10099	
1999-1998; OE Type Radiator Cap .....	10230	16	<b>Traverse</b>		
1999-1998; OE Equivalent Fuel Cap .....	10830		<b>V-6 3.6 L</b>		
1999-1998; Diesel Regular Non-Locking Fuel Cap .....	10830D		2011; OE Type Radiator Cap .....	10248	15
1999-1998; Regular Locking Fuel Cap .....	10591		2011; OE Equivalent Fuel Cap .....	10834	
1999-1998; Diesel Regular Locking Fuel Cap .....	10591D		2011; Regular Locking Fuel Cap .....	10504	
1999-1998; Oil Filler Cap .....	10099		2010-2009; OE Type Radiator Cap .....	10248	15
1997; Lev-R-Vent Radiator Cap .....	10330	16	2010-2009; OE Equivalent Fuel Cap .....	10841	
1997; OE Type Radiator Cap .....	10230	16	2010-2009; Regular Locking Fuel Cap .....	10511	
1997; OE Equivalent Fuel Cap .....	10830		2010-2009; Oil Filler Cap .....	10099	
1997; Regular Locking Fuel Cap .....	10591		<b>Uplander</b>		
1997; Diesel Pre-Vent Non-Locking Fuel Cap .....	10819D		<b>V-6 3.5 L</b>		
1997; Diesel Regular Non-Locking Fuel Cap .....	10830D		2006; Lev-R-Vent Radiator Cap .....	10331	16
1997; Diesel Only Pre-Vent Locking Fuel Cap .....	10501D		2006; OE Type Radiator Cap .....	10231	16
1997; Diesel Regular Locking Fuel Cap .....	10591D		2006; OE Equivalent Fuel Cap .....	10841	
1997; Oil Filler Cap; W/Metal Oil Cap .....	10066		2006; Regular Locking Fuel Cap .....	10523	
1997; Oil Filler Cap; W/O Metal Oil Cap .....	10099		2006; Oil Filler Cap .....	10099	
1996-1995; Lev-R-Vent Radiator Cap .....	10330	16	2005; Lev-R-Vent Radiator Cap .....	10331	16
1996-1995; OE Type Radiator Cap .....	10230	16	2005; OE Type Radiator Cap .....	10231	16
1996-1995; OE Equivalent Fuel Cap .....	10830		2005; Coolant Recovery Tank Cap .....	10236	
1996-1995; Regular Locking Fuel Cap .....	10591		2005; OE Equivalent Fuel Cap .....	10841	
1996-1995; Diesel Pre-Vent Non-Locking Fuel Cap .....	10819D		2005; Regular Locking Fuel Cap .....	10523	
1996-1995; Diesel Regular Non-Locking Fuel Cap .....	10830D		2005; Oil Filler Cap .....	10099	
1996-1995; Diesel Only Pre-Vent Locking Fuel Cap .....	10501D		<b>V-6 3.9 L</b>		
1996-1995; Diesel Regular Locking Fuel Cap .....	10591D		2008-2006; OE Equivalent Fuel Cap .....	10841	
1996-1995; Oil Filler Cap .....	10066		2008-2006; Regular Locking Fuel Cap .....	10523	

## Caps for Passenger Cars and Light Trucks (1990 and Newer)

Application	Part Number	PSI	Application	Part Number	PSI
<b>Chevrolet - Continued</b>			<b>Chrysler - Continued</b>		
<b>Uplander - Continued</b>			<b>300M - Continued</b>		
<b>V-6 3.9 L - Continued</b>			<b>V-6 3.5 L - Continued</b>		
2008-2006; Oil Filler Cap .....	10099		1999; Lev-R-Vent Radiator Cap .....	10330	16
<b>Venture</b>			1999; OE Type Radiator Cap .....	10230	16
<b>V-6 3.4 L</b>			1999; OE Equivalent Fuel Cap .....	10817	
2005-1998; Lev-R-Vent Radiator Cap .....	10331	16	1999; Pre-Vent Non-Locking Fuel Cap .....	10819	
2005-1998; OE Type Radiator Cap .....	10231	16	1999; Regular Locking Fuel Cap .....	10591	
2005-1998; OE Equivalent Fuel Cap .....	10836		1999; Pre-Vent Locking Fuel Cap .....	10501	
2005-1998; Regular Locking Fuel Cap .....	10506		1999; Oil Filler Cap .....	10111	
2005-1998; Oil Filler Cap .....	10099		<b>Aspen</b>		
1997; Lev-R-Vent Radiator Cap .....	10331	16	<b>V-8 4.7 L</b>		
1997; OE Type Radiator Cap .....	10231	16	2009; Lev-R-Vent Radiator Cap .....	10335	20
1997; OE Equivalent Fuel Cap .....	10817		2009; OE Type Radiator Cap .....	10235	20
1997; Pre-Vent Non-Locking Fuel Cap .....	10819		2009; OE Equivalent Fuel Cap .....	10838	
1997; Regular Locking Fuel Cap .....	10591		2009; Regular Locking Fuel Cap .....	10508	
1997; Pre-Vent Locking Fuel Cap .....	10501		2009; Flex Fuel Regular Fuel Cap .....	10838Y	
1997; Oil Filler Cap .....	10099		2009; Flex Fuel Regular Locking Fuel Cap .....	10508Y	
<b>Chrysler</b>			2009; Oil Filler Cap .....	10120	
<b>200</b>			2008; Lev-R-Vent Radiator Cap .....	10335	20
<b>4-Cyl. 2.4 L</b>			2008; OE Type Radiator Cap .....	10235	20
2012-2011; OE Equivalent Fuel Cap .....	10838		2008; OE Equivalent Fuel Cap .....	10838	
2012-2011; Regular Locking Fuel Cap .....	10508		2008; Regular Locking Fuel Cap .....	10508	
<b>V-6 3.6 L</b>			2008; Flex Fuel Regular Fuel Cap .....	10838Y	
2012; OE Equivalent Fuel Cap .....	10838		2008; Flex Fuel Regular Locking Fuel Cap .....	10508Y	
2012; Flex Fuel Regular Fuel Cap .....	10838Y		2007; Lev-R-Vent Radiator Cap .....	10335	20
2012; Regular Locking Fuel Cap .....	10508		2007; OE Type Radiator Cap .....	10235	20
2012; Flex Fuel Regular Locking Fuel Cap .....	10508Y		2007; OE Equivalent Fuel Cap .....	10838	
2011; OE Type Radiator Cap .....	10230	16	2007; Flex Fuel Regular Fuel Cap .....	10838Y	
2011; Lev-R-Vent Radiator Cap .....	10330	16	2007; Regular Locking Fuel Cap .....	10508	
2011; OE Equivalent Fuel Cap .....	10838		2007; Flex Fuel Regular Locking Fuel Cap .....	10508Y	
2011; Flex Fuel Regular Fuel Cap .....	10838Y		2007; Oil Filler Cap .....	10120	
2011; Regular Locking Fuel Cap .....	10508		<b>V-8 5.7 L</b>		
2011; Flex Fuel Regular Locking Fuel Cap .....	10508Y		2009; Lev-R-Vent Radiator Cap .....	10335	20
<b>300</b>			2009; OE Type Radiator Cap .....	10235	20
<b>V-6 2.7 L</b>			2009; OE Equivalent Fuel Cap .....	10838	
2010-2005; Lev-R-Vent Radiator Cap .....	10334	18	2009; Regular Locking Fuel Cap .....	10508	
2010-2005; OE Type Radiator Cap .....	10234	18	2009; Oil Filler Cap .....	10111	
2010-2005; OE Equivalent Fuel Cap .....	10838		2008-2007; Lev-R-Vent Radiator Cap .....	10335	20
2010-2005; Regular Locking Fuel Cap .....	10508		2008-2007; OE Type Radiator Cap .....	10235	20
2010-2005; Oil Filler Cap .....	10099		2008-2007; OE Equivalent Fuel Cap .....	10838	
<b>V-6 3.5 L</b>			2008-2007; Regular Locking Fuel Cap .....	10508	
2010; Lev-R-Vent Radiator Cap .....	10334	18	2008-2007; Oil Filler Cap .....	10145	
2010; OE Type Radiator Cap .....	10234	18	<b>V-8 5.7 L Electric Assist</b>		
2010; OE Equivalent Fuel Cap .....	10838		2009; Lev-R-Vent Radiator Cap .....	10335	20
2010; Regular Locking Fuel Cap .....	10508		2009; OE Type Radiator Cap .....	10235	20
2010; Oil Filler Cap .....	10120		2009; OE Equivalent Fuel Cap .....	10838	
2009-2007; Lev-R-Vent Radiator Cap .....	10334	18	2009; Regular Locking Fuel Cap .....	10508	
2009-2007; OE Type Radiator Cap .....	10234	18	2009; Oil Filler Cap .....	10111	
2009-2007; OE Equivalent Fuel Cap .....	10838		<b>Cirrus</b>		
2009-2007; Regular Locking Fuel Cap .....	10508		<b>4-Cyl. 2.0 L</b>		
2009-2007; Oil Filler Cap .....	10148		2000; Lev-R-Vent Radiator Cap .....	10331	16
2006-2005; Lev-R-Vent Radiator Cap .....	10334	18	2000; OE Type Radiator Cap .....	10231	16
2006-2005; OE Type Radiator Cap .....	10234	18	2000; OE Equivalent Fuel Cap .....	10838	
2006-2005; OE Equivalent Fuel Cap .....	10838		2000; Regular Locking Fuel Cap .....	10508	
2006-2005; Regular Locking Fuel Cap .....	10508		<b>4-Cyl. 2.4 L</b>		
2006-2005; Oil Filler Cap .....	10111		2000; Lev-R-Vent Radiator Cap .....	10331	16
<b>V-8 5.7 L; V-8 6.1 L</b>			2000; OE Type Radiator Cap .....	10231	16
2010-2005; Lev-R-Vent Radiator Cap .....	10334	18	2000; OE Equivalent Fuel Cap .....	10838	
2010-2005; OE Type Radiator Cap .....	10234	18	2000; Regular Locking Fuel Cap .....	10508	
2010-2005; OE Equivalent Fuel Cap .....	10838		2000; Oil Filler Cap .....	10111	
2010-2005; Regular Locking Fuel Cap .....	10508		1997-1995; Lev-R-Vent Radiator Cap .....	10331	16
2010-2005; Oil Filler Cap .....	10111		1997-1995; OE Type Radiator Cap .....	10231	16
<b>300M</b>			1997-1995; OE Equivalent Fuel Cap .....	10817	
<b>V-6 3.5 L</b>			1997-1995; Pre-Vent Non-Locking Fuel Cap .....	10819	
2004-2000; Lev-R-Vent Radiator Cap .....	10330	16	1997-1995; Regular Locking Fuel Cap .....	10591	
2004-2000; OE Type Radiator Cap .....	10230	16	1997-1995; Pre-Vent Locking Fuel Cap .....	10501	
2004-2000; OE Equivalent Fuel Cap .....	10838		1997-1995; Oil Filler Cap .....	10111	
2004-2000; Regular Locking Fuel Cap .....	10508		<b>V-6 2.5 L</b>		
2004-2000; Oil Filler Cap .....	10111		2000; Lev-R-Vent Radiator Cap .....	10331	16
			2000; OE Type Radiator Cap .....	10231	16
			2000; OE Equivalent Fuel Cap .....	10838	
			2000; Regular Locking Fuel Cap .....	10508	

## Caps for Passenger Cars and Light Trucks (1990 and Newer)

Application	Part Number	PSI	Application	Part Number	PSI
<b>Chrysler - Continued</b>			<b>Chrysler - Continued</b>		
<b>Cirrus - Continued</b>			<b>Grand Voyager - Continued</b>		
<b>V-6 2.5 L - Continued</b>			<b>V-6 3.3 L - Continued</b>		
2000; Oil Filler Cap .....	10088		2000; Oil Filler Cap .....	10111	
1999-1995; Lev-R-Vent Radiator Cap .....	10331	16	<b>Intrepid</b>		
1999-1995; OE Type Radiator Cap .....	10231	16	<b>V-6 2.7 L (Canada)</b>		
1999-1995; OE Equivalent Fuel Cap .....	10817		2004-2000; Lev-R-Vent Radiator Cap .....	10330	16
1999-1995; Pre-Vent Non-Locking Fuel Cap .....	10819		2004-2000; OE Type Radiator Cap .....	10230	16
1999-1995; Regular Locking Fuel Cap .....	10591		2004-2000; OE Equivalent Fuel Cap .....	10838	
1999-1995; Pre-Vent Locking Fuel Cap .....	10501		2004-2000; Regular Locking Fuel Cap .....	10508	
1999-1995; Oil Filler Cap .....	10088		2004-2000; Oil Filler Cap .....	10099	
<b>Concorde</b>			2004-2000; Lev-R-Vent Radiator Cap .....	10330	16
<b>V-6 2.7 L</b>			1999-1998; Lev-R-Vent Radiator Cap .....	10330	16
2004-1999; Lev-R-Vent Radiator Cap .....	10330	16	1999-1998; OE Type Radiator Cap .....	10230	16
2004-1999; OE Type Radiator Cap .....	10230	16	1999-1998; OE Equivalent Fuel Cap .....	10817	
2004-1999; OE Equivalent Fuel Cap .....	10838		1999-1998; Pre-Vent Non-Locking Fuel Cap .....	10819	
2004-1999; Regular Locking Fuel Cap .....	10508		1999-1998; Regular Locking Fuel Cap .....	10591	
2004-1999; Oil Filler Cap .....	10099		1999-1998; Pre-Vent Locking Fuel Cap .....	10501	
1998; Lev-R-Vent Radiator Cap .....	10330	16	1999-1998; Oil Filler Cap .....	10099	
1998; OE Type Radiator Cap .....	10230	16	<b>V-6 3.2 L (Canada)</b>		
1998; OE Equivalent Fuel Cap .....	10817		2001-2000; Lev-R-Vent Radiator Cap .....	10330	16
1998; Pre-Vent Non-Locking Fuel Cap .....	10819		2001-2000; OE Type Radiator Cap .....	10230	16
1998; Regular Locking Fuel Cap .....	10591		2001-2000; OE Equivalent Fuel Cap .....	10838	
1998; Pre-Vent Locking Fuel Cap .....	10501		2001-2000; Regular Locking Fuel Cap .....	10508	
1998; Oil Filler Cap .....	10099		2001-2000; Oil Filler Cap .....	10111	
<b>V-6 3.2 L</b>			1999-1998; Lev-R-Vent Radiator Cap .....	10330	16
2001-2000; Lev-R-Vent Radiator Cap .....	10330	16	1999-1998; OE Type Radiator Cap .....	10230	16
2001-2000; OE Type Radiator Cap .....	10230	16	1999-1998; OE Equivalent Fuel Cap .....	10817	
2001-2000; OE Equivalent Fuel Cap .....	10838		1999-1998; Pre-Vent Non-Locking Fuel Cap .....	10819	
2001-2000; Regular Locking Fuel Cap .....	10508		1999-1998; Regular Locking Fuel Cap .....	10591	
2001-2000; Oil Filler Cap .....	10111		1999-1998; Pre-Vent Locking Fuel Cap .....	10501	
1999-1998; Lev-R-Vent Radiator Cap .....	10330	16	1999-1998; Oil Filler Cap .....	10111	
1999-1998; OE Type Radiator Cap .....	10230	16	<b>V-6 3.3 L (Canada)</b>		
1999-1998; OE Equivalent Fuel Cap .....	10817		1997-1995; Lev-R-Vent Radiator Cap .....	10330	16
1999-1998; Pre-Vent Non-Locking Fuel Cap .....	10819		1997-1995; OE Type Radiator Cap .....	10230	16
1999-1998; Regular Locking Fuel Cap .....	10591		1997-1995; OE Equivalent Fuel Cap .....	10817	
1999-1998; Pre-Vent Locking Fuel Cap .....	10501		1997-1995; Pre-Vent Non-Locking Fuel Cap .....	10819	
1999-1998; Oil Filler Cap .....	10111		1997-1995; Regular Locking Fuel Cap .....	10591	
<b>V-6 3.3 L</b>			1997-1995; Pre-Vent Locking Fuel Cap .....	10501	
1996-1995; Lev-R-Vent Radiator Cap .....	10330	16	1997-1995; Oil Filler Cap .....	10066	
1996-1995; OE Type Radiator Cap .....	10230	16	<b>V-6 3.5 L (Canada)</b>		
1996-1995; OE Equivalent Fuel Cap .....	10817		2004-2000; Lev-R-Vent Radiator Cap .....	10330	16
1996-1995; Pre-Vent Non-Locking Fuel Cap .....	10819		2004-2000; OE Type Radiator Cap .....	10230	16
1996-1995; Regular Locking Fuel Cap .....	10591		2004-2000; OE Equivalent Fuel Cap .....	10838	
1996-1995; Pre-Vent Locking Fuel Cap .....	10501		2004-2000; Regular Locking Fuel Cap .....	10508	
1996-1995; Oil Filler Cap .....	10066		2004-2000; Oil Filler Cap .....	10111	
<b>V-6 3.5 L</b>			1997-1995; Lev-R-Vent Radiator Cap .....	10330	16
2004-2002; Lev-R-Vent Radiator Cap .....	10330	16	1997-1995; OE Type Radiator Cap .....	10230	16
2004-2002; OE Type Radiator Cap .....	10230	16	1997-1995; OE Equivalent Fuel Cap .....	10817	
2004-2002; OE Equivalent Fuel Cap .....	10838		1997-1995; Pre-Vent Non-Locking Fuel Cap .....	10819	
2004-2002; Regular Locking Fuel Cap .....	10508		1997-1995; Regular Locking Fuel Cap .....	10591	
2004-2002; Oil Filler Cap .....	10111		1997-1995; Pre-Vent Locking Fuel Cap .....	10501	
1997-1995; Lev-R-Vent Radiator Cap .....	10330	16	1997-1995; Oil Filler Cap .....	10111	
1997-1995; OE Type Radiator Cap .....	10230	16	2004-2000; Lev-R-Vent Radiator Cap .....	10330	16
1997-1995; OE Equivalent Fuel Cap .....	10817		2004-2000; OE Type Radiator Cap .....	10230	16
1997-1995; Pre-Vent Non-Locking Fuel Cap .....	10819		2004-2000; OE Equivalent Fuel Cap .....	10838	
1997-1995; Regular Locking Fuel Cap .....	10591		2004-2000; Regular Locking Fuel Cap .....	10508	
1997-1995; Pre-Vent Locking Fuel Cap .....	10501		2004-2000; Oil Filler Cap .....	10111	
1997-1995; Oil Filler Cap .....	10111		1997-1995; Lev-R-Vent Radiator Cap .....	10330	16
<b>Grand Voyager</b>			1997-1995; OE Type Radiator Cap .....	10230	16
<b>V-6 3.0 L</b>			1997-1995; OE Equivalent Fuel Cap .....	10817	
2000; Lev-R-Vent Radiator Cap .....	10331	16	1997-1995; Pre-Vent Non-Locking Fuel Cap .....	10819	
2000; OE Type Radiator Cap .....	10231	16	1997-1995; Regular Locking Fuel Cap .....	10591	
2000; OE Equivalent Fuel Cap .....	10838		1997-1995; Pre-Vent Locking Fuel Cap .....	10501	
2000; Regular Locking Fuel Cap .....	10508		1997-1995; Oil Filler Cap .....	10111	
2000; Oil Filler Cap .....	10088		<b>Lebaron</b>		
<b>V-6 3.3 L</b>			<b>V-6 3.0 L</b>		
2000; Lev-R-Vent Radiator Cap .....	10331	16	1995; Lev-R-Vent Radiator Cap .....	10331	16
2000; OE Type Radiator Cap .....	10231	16	1995; OE Type Radiator Cap .....	10231	16
2000; OE Equivalent Fuel Cap .....	10838		1995; OE Equivalent Fuel Cap .....	10817	
2000; Flex Fuel Regular Fuel Cap .....	10838Y		1995; Pre-Vent Non-Locking Fuel Cap .....	10819	
2000; Regular Locking Fuel Cap .....	10508		1995; Regular Locking Fuel Cap .....	10591	
2000; Flex Fuel Regular Locking Fuel Cap .....	10508Y		1995; Pre-Vent Locking Fuel Cap .....	10501	
			1995; Oil Filler Cap .....	10088	



## Caps for Passenger Cars and Light Trucks (1990 and Newer)

Application	Part Number	PSI	Application	Part Number	PSI
<b>Chrysler - Continued</b>			<b>Chrysler - Continued</b>		
<b>LHS</b>			<b>PT Cruiser - Continued</b>		
<b>V-6 3.5 L</b>			<b>4-Cyl. 2.4 L - Continued</b>		
2001-2000; Lev-R-Vent Radiator Cap .....	10330	16	2006; OE Type Radiator Cap .....	10234	18
2001-2000; OE Type Radiator Cap .....	10230	16	2006; OE Equivalent Fuel Cap .....	10838	
2001-2000; OE Equivalent Fuel Cap .....	10838		2006; Regular Locking Fuel Cap .....	10508	
2001-2000; Regular Locking Fuel Cap .....	10508		2006; Oil Filler Cap .....	10111	
2001-2000; Oil Filler Cap .....	10111		2005; Lev-R-Vent Radiator Cap; W/Turbo .....	10334	18
1999; Lev-R-Vent Radiator Cap .....	10330	16	2005; OE Type Radiator Cap; W/Turbo .....	10234	18
1999; OE Type Radiator Cap .....	10230	16	2005; Lev-R-Vent Radiator Cap; W/O Turbo .....	10330	16
1999; OE Equivalent Fuel Cap .....	10817		2005; OE Type Radiator Cap; W/O Turbo .....	10230	16
1999; Pre-Vent Non-Locking Fuel Cap .....	10819		2005; OE Equivalent Fuel Cap .....	10838	
1999; Regular Locking Fuel Cap .....	10591		2005; Regular Locking Fuel Cap .....	10508	
1999; Pre-Vent Locking Fuel Cap .....	10501		2005; Oil Filler Cap .....	10099	
1999; Oil Filler Cap .....	10111		2004-2003; Lev-R-Vent Radiator Cap; W/O Turbo .....	10330	16
1997-1995; Lev-R-Vent Radiator Cap .....	10330	16	2004-2003; OE Type Radiator Cap; W/O Turbo .....	10230	16
1997-1995; OE Type Radiator Cap .....	10230	16	2004-2003; Lev-R-Vent Radiator Cap; W/Turbo .....	10334	18
1997-1995; OE Equivalent Fuel Cap .....	10817		2004-2003; OE Type Radiator Cap; W/Turbo .....	10234	18
1997-1995; Pre-Vent Non-Locking Fuel Cap .....	10819		2004-2003; OE Equivalent Fuel Cap .....	10838	
1997-1995; Regular Locking Fuel Cap .....	10591		2004-2003; Regular Locking Fuel Cap .....	10508	
1997-1995; Pre-Vent Locking Fuel Cap .....	10501		2004-2003; Oil Filler Cap .....	10111	
1997-1995; Oil Filler Cap .....	10111		2002-2001; Lev-R-Vent Radiator Cap .....	10330	16
<b>New Yorker</b>			2002-2001; OE Type Radiator Cap .....	10230	16
<b>V-6 3.5 L</b>			2002-2001; OE Equivalent Fuel Cap .....	10838	
1996-1995; Lev-R-Vent Radiator Cap .....	10330	16	2002-2001; Regular Locking Fuel Cap .....	10508	
1996-1995; OE Type Radiator Cap .....	10230	16	2002-2001; Oil Filler Cap .....	10111	
1996-1995; OE Equivalent Fuel Cap .....	10817		<b>Sebring</b>		
1996-1995; Pre-Vent Non-Locking Fuel Cap .....	10819		<b>4-Cyl. 2.0 L</b>		
1996-1995; Regular Locking Fuel Cap .....	10591		1999-1997; Lev-R-Vent Radiator Cap .....	✓10333	16
1996-1995; Pre-Vent Locking Fuel Cap .....	10501		1999-1997; OE Type Radiator Cap .....	10233	16
1996-1995; Oil Filler Cap .....	10111		1999-1997; OE Equivalent Fuel Cap .....	10817	
<b>Pacifica</b>			1999-1997; Pre-Vent Non-Locking Fuel Cap .....	10819	
<b>V-6 3.5 L</b>			1999-1997; Regular Locking Fuel Cap .....	10591	
2006-2004; Lev-R-Vent Radiator Cap .....	10334	18	1999-1997; Pre-Vent Locking Fuel Cap .....	10501	
2006-2004; OE Type Radiator Cap .....	10234	18	1999-1997; Oil Filler Cap .....	10111	
2006-2004; OE Equivalent Fuel Cap .....	10838		1996-1995; Lev-R-Vent Radiator Cap .....	✓10333	16
2006-2004; Regular Locking Fuel Cap .....	10508		1996-1995; OE Type Radiator Cap .....	10233	16
2006-2004; Oil Filler Cap .....	10099		1996-1995; OE Equivalent Fuel Cap .....	10817	
<b>V-6 3.8 L</b>			1996-1995; Pre-Vent Non-Locking Fuel Cap .....	10819	
2008-2005; Lev-R-Vent Radiator Cap .....	10334	18	1996-1995; Regular Locking Fuel Cap .....	10591	
2008-2005; OE Type Radiator Cap .....	10234	18	1996-1995; Pre-Vent Locking Fuel Cap .....	10501	
2008-2005; OE Equivalent Fuel Cap .....	10838		1996-1995; Oil Filler Cap .....	10088	
2008-2005; Regular Locking Fuel Cap .....	10508		<b>4-Cyl. 2.4 L</b>		
2008-2005; Oil Filler Cap .....	10111		2010; OE Equivalent Fuel Cap .....	10838	
<b>V-6 4.0 L</b>			2010; Regular Locking Fuel Cap .....	10508	
2008-2007; Lev-R-Vent Radiator Cap .....	10334	18	2010; Oil Filler Cap .....	10111	
2008-2007; OE Type Radiator Cap .....	10234	18	2009-2007; Lev-R-Vent Radiator Cap .....	10330	16
2008-2007; OE Equivalent Fuel Cap .....	10838		2009-2007; OE Type Radiator Cap .....	10230	16
2008-2007; Regular Locking Fuel Cap .....	10508		2009-2007; OE Equivalent Fuel Cap .....	10838	
2008-2007; Oil Filler Cap .....	10148		2009-2007; Regular Locking Fuel Cap .....	10508	
<b>Prowler</b>			2009-2007; Oil Filler Cap .....	10111	
<b>V-6 3.5 L</b>			2006; Lev-R-Vent Radiator Cap .....	10334	18
2002-2001; Lev-R-Vent Radiator Cap .....	10330	16	2006; OE Type Radiator Cap .....	10234	18
2002-2001; OE Type Radiator Cap .....	10230	16	2006; OE Equivalent Fuel Cap .....	10838	
2002-2001; OE Equivalent Fuel Cap .....	10817		2006; Regular Locking Fuel Cap .....	10508	
2002-2001; Pre-Vent Non-Locking Fuel Cap .....	10819		2006; Oil Filler Cap .....	10111	
2002-2001; Regular Locking Fuel Cap .....	10591		2005-2004; OE Type Radiator Cap; W/SOHC Eng. ....	10242	16
2002-2001; Pre-Vent Locking Fuel Cap .....	10501		2005-2004; OE Type Radiator Cap; W/DOHC Eng. ....	10234	18
<b>PT Cruiser</b>			2005-2004; Lev-R-Vent Radiator Cap; W/DOHC Eng. ....	10334	18
<b>4-Cyl. 2.4 L</b>			2005-2004; OE Equivalent Fuel Cap .....	10838	
2009; OE Equivalent Fuel Cap .....	10838		2005-2004; Regular Locking Fuel Cap .....	10508	
2009; Regular Locking Fuel Cap .....	10508		2005-2004; Oil Filler Cap; W/SOHC Eng. ....	10088	
2009; Oil Filler Cap .....	10111		2005-2004; Oil Filler Cap; W/DOHC Eng. ....	10111	
2008-2007; Lev-R-Vent Radiator Cap; W/Turbo .....	10334	18	2003; OE Type Radiator Cap; Eng. VIN G .....	10242	16
2008-2007; OE Type Radiator Cap; W/Turbo .....	10234	18	2003; OE Type Radiator Cap; Eng. VIN X .....	10234	18
2008-2007; Lev-R-Vent Radiator Cap; W/O Turbo .....	10330	16	2003; Lev-R-Vent Radiator Cap; Eng. VIN X .....	10334	18
2008-2007; OE Type Radiator Cap; W/O Turbo .....	10230	16	2003; OE Equivalent Fuel Cap .....	10838	
2008-2007; OE Equivalent Fuel Cap .....	10838		2003; Regular Locking Fuel Cap .....	10508	
2008-2007; Regular Locking Fuel Cap .....	10508		2003; Oil Filler Cap; Eng. VIN X .....	10111	
2008-2007; Oil Filler Cap .....	10111		2003; Oil Filler Cap; Eng. VIN G .....	10088	
2006; Lev-R-Vent Radiator Cap .....	10334	18	2002; OE Type Radiator Cap .....	10234	18
<b>4-Cyl. 2.4 L</b>			2002; Lev-R-Vent Radiator Cap .....	10334	18
2010; OE Equivalent Fuel Cap .....	10838		2002; OE Equivalent Fuel Cap .....	10838	
2010; Regular Locking Fuel Cap .....	10508		2002; Regular Locking Fuel Cap .....	10508	
2010; Oil Filler Cap .....	10111				

✓ Check Hood Clearance prior to installing this Cap.

## Caps for Passenger Cars and Light Trucks (1990 and Newer)

Application	Part Number	PSI	Application	Part Number	PSI
<b>Chrysler - Continued</b>			<b>Chrysler - Continued</b>		
<b>Sebring - Continued</b>			<b>Sebring - Continued</b>		
<b>4-Cyl. 2.4 L - Continued</b>			<b>V-6 2.7 L - Continued</b>		
2002: Oil Filler Cap .....	10111		2007: OE Type Radiator Cap .....	10230	16
2001: Lev-R-Vent Radiator Cap .....	10331	16	2007: OE Equivalent Fuel Cap .....	10838	
2001: OE Type Radiator Cap .....	10231	16	2007: Regular Locking Fuel Cap .....	10508	
2001: OE Equivalent Fuel Cap .....	10838		2007: Oil Filler Cap .....	10099	
2001: Regular Locking Fuel Cap .....	10508		2006-2004: Lev-R-Vent Radiator Cap .....	10330	16
2001: Oil Filler Cap .....	10111		2006-2004: OE Type Radiator Cap .....	10230	16
1999-1997: Lev-R-Vent Radiator Cap .....	10331	16	2006-2004: OE Equivalent Fuel Cap .....	10838	
1999-1997: OE Type Radiator Cap .....	10231	16	2006-2004: Flex Fuel Regular Fuel Cap .....	10838Y	
1999-1997: OE Equivalent Fuel Cap .....	10817		2006-2004: Regular Locking Fuel Cap .....	10508	
1999-1997: Pre-Vent Non-Locking Fuel Cap .....	10819		2006-2004: Flex Fuel Regular Locking Fuel Cap .....	10508Y	
1999-1997: Regular Locking Fuel Cap .....	10591		2006-2004: Oil Filler Cap .....	10099	
1999-1997: Pre-Vent Locking Fuel Cap .....	10501		2003-2001: Lev-R-Vent Radiator Cap .....	10330	16
1999-1997: Oil Filler Cap .....	10111		2003-2001: OE Type Radiator Cap .....	10230	16
1996: Lev-R-Vent Radiator Cap .....	10331	16	2003-2001: OE Equivalent Fuel Cap .....	10838	
1996: OE Type Radiator Cap .....	10231	16	2003-2001: Regular Locking Fuel Cap .....	10508	
1996: OE Equivalent Fuel Cap .....	10817		2003-2001: Oil Filler Cap .....	10099	
1996: Pre-Vent Non-Locking Fuel Cap .....	10819				
1996: Regular Locking Fuel Cap .....	10591		<b>V-6 3.0 L</b>		
1996: Pre-Vent Locking Fuel Cap .....	10501		2005-2001: OE Type Radiator Cap .....	10242	16
1996: Oil Filler Cap .....	10088		2005-2001: OE Equivalent Fuel Cap .....	10838	
			2005-2001: Regular Locking Fuel Cap .....	10508	
<b>V-6 2.5 L</b>			2005-2001: Oil Filler Cap .....	10088	
2000: Lev-R-Vent Radiator Cap .....	10330	16			
2000: OE Type Radiator Cap .....	10230	16	<b>V-6 3.5 L</b>		
2000: OE Equivalent Fuel Cap .....	10838		2010: Lev-R-Vent Radiator Cap .....	10334	18
2000: Regular Locking Fuel Cap .....	10508		2010: OE Type Radiator Cap .....	10234	18
2000: Oil Filler Cap .....	10088		2010: OE Equivalent Fuel Cap .....	10838	
1999: Lev-R-Vent Radiator Cap .....	10330	16	2010: Regular Locking Fuel Cap .....	10508	
1999: OE Type Radiator Cap .....	10230	16	2010: Oil Filler Cap .....	10120	
1999: OE Equivalent Fuel Cap .....	10817		2009-2007: Lev-R-Vent Radiator Cap .....	10330	16
1999: Pre-Vent Non-Locking Fuel Cap .....	10819		2009-2007: OE Type Radiator Cap .....	10230	16
1999: Regular Locking Fuel Cap .....	10591		2009-2007: OE Equivalent Fuel Cap .....	10838	
1999: Pre-Vent Locking Fuel Cap .....	10501		2009-2007: Regular Locking Fuel Cap .....	10508	
1999: Oil Filler Cap .....	10088		2009-2007: Oil Filler Cap .....	10148	
1998-1997: Lev-R-Vent Radiator Cap; Eng. VIN H .....	10330	16			
1998-1997: OE Type Radiator Cap; Eng. VIN H .....	10230	16	<b>Town &amp; Country Van</b>		
1998-1997: Lev-R-Vent Radiator Cap; Eng. VIN N .....	✓10327	13	<b>V-6 3.3 L</b>		
1998-1997: OE Type Radiator Cap; Eng. VIN N .....	10227	13	2010: Lev-R-Vent Radiator Cap .....	10331	16
1998-1997: OE Equivalent Fuel Cap .....	10817		2010: OE Type Radiator Cap .....	10231	16
1998-1997: Pre-Vent Non-Locking Fuel Cap .....	10819		2010: OE Equivalent Fuel Cap .....	10838	
1998-1997: Regular Locking Fuel Cap .....	10591		2010: Regular Locking Fuel Cap .....	10508	
1998-1997: Pre-Vent Locking Fuel Cap .....	10501		2010: Oil Filler Cap .....	10111	
1998-1997: Oil Filler Cap .....	10088		2009-2008: Lev-R-Vent Radiator Cap .....	10331	16
1996: Lev-R-Vent Radiator Cap; Eng. VIN H .....	10331	16	2009-2008: OE Type Radiator Cap .....	10231	16
1996: OE Type Radiator Cap; Eng. VIN H .....	10231	16	2009-2008: OE Equivalent Fuel Cap .....	10838	
1996: Lev-R-Vent Radiator Cap; Eng. VIN N .....	✓10327	13	2009-2008: Regular Locking Fuel Cap .....	10508	
1996: OE Type Radiator Cap; Eng. VIN N .....	10227	13	2009-2008: Flex Fuel Regular Fuel Cap .....	10838Y	
1996: OE Equivalent Fuel Cap .....	10817		2009-2008: Flex Fuel Regular Locking Fuel Cap .....	10508Y	
1996: Pre-Vent Non-Locking Fuel Cap .....	10819		2009-2008: Oil Filler Cap .....	10111	
1996: Regular Locking Fuel Cap .....	10591		2007-2004: Lev-R-Vent Radiator Cap .....	10331	16
1996: Pre-Vent Locking Fuel Cap .....	10501		2007-2004: OE Type Radiator Cap .....	10231	16
1996: Oil Filler Cap .....	10088		2007-2004: OE Equivalent Fuel Cap .....	10838	
1995: Lev-R-Vent Radiator Cap .....	✓10327	13	2007-2004: Regular Locking Fuel Cap .....	10508	
1995: OE Type Radiator Cap .....	10227	13	2007-2004: Oil Filler Cap .....	10111	
1995: OE Equivalent Fuel Cap .....	10817		2003-2000: Lev-R-Vent Radiator Cap .....	10331	16
1995: Pre-Vent Non-Locking Fuel Cap .....	10819		2003-2000: OE Type Radiator Cap .....	10231	16
1995: Regular Locking Fuel Cap .....	10591		2003-2000: OE Equivalent Fuel Cap .....	10838	
1995: Pre-Vent Locking Fuel Cap .....	10501		2003-2000: Flex Fuel Regular Fuel Cap .....	10838Y	
1995: Oil Filler Cap .....	10088		2003-2000: Regular Locking Fuel Cap .....	10508	
			2003-2000: Flex Fuel Regular Locking Fuel Cap .....	10508Y	
<b>V-6 2.7 L</b>			2003-2000: Oil Filler Cap .....	10111	
2010: OE Equivalent Fuel Cap .....	10838		1999: Lev-R-Vent Radiator Cap .....	10331	16
2010: Flex Fuel Regular Fuel Cap .....	10838Y		1999: OE Type Radiator Cap .....	10231	16
2010: Regular Locking Fuel Cap .....	10508		1999: OE Equivalent Fuel Cap; Nov. 1, 1998 & Newer .....	10838	
2010: Flex Fuel Regular Locking Fuel Cap .....	10508Y		1999: Flex Fuel Regular Fuel Cap; Nov. 1, 1998 & Newer .....	10838Y	
2010: Oil Filler Cap .....	10099		1999: Regular Locking Fuel Cap; Nov. 1, 1998 & Newer .....	10508	
2009-2008: Lev-R-Vent Radiator Cap .....	10330	16	1999: Flex Fuel Regular Locking Fuel Cap; Nov. 1, 1998 & Newer .....	10508Y	
2009-2008: OE Type Radiator Cap .....	10230	16	1999: OE Equivalent Fuel Cap; Oct. 31, 1998 & Older .....	10817	
2009-2008: OE Equivalent Fuel Cap .....	10838		1999: Pre-Vent Non-Locking Fuel Cap; Oct. 31, 1998 & Older ...	10819	
2009-2008: Regular Locking Fuel Cap .....	10508		1999: Regular Locking Fuel Cap; Oct. 31, 1998 & Older .....	10591	
2009-2008: Flex Fuel Regular Fuel Cap .....	10838Y		1999: Pre-Vent Locking Fuel Cap; Oct. 31, 1998 & Older .....	10501	
2009-2008: Flex Fuel Regular Locking Fuel Cap .....	10508Y		1999: Oil Filler Cap .....	10111	
2009-2008: Oil Filler Cap .....	10099		1998-1996: Lev-R-Vent Radiator Cap .....	10331	16
2007: Lev-R-Vent Radiator Cap .....	10330	16			

✓ Check Hood Clearance prior to installing this Cap.

## Caps for Passenger Cars and Light Trucks (1990 and Newer)

Application	Part Number	PSI	Application	Part Number	PSI
<b>Chrysler - Continued</b>			<b>Chrysler - Continued</b>		
<b>Town &amp; Country Van - Continued</b>			<b>Voyager - Continued</b>		
<b>V-6 3.3 L - Continued</b>			<b>V-6 3.3 L - Continued</b>		
1998-1996: OE Type Radiator Cap .....	10231	16	2001: OE Equivalent Fuel Cap .....	10838	
1998-1996: OE Equivalent Fuel Cap .....	10817		2001: Regular Locking Fuel Cap .....	10508	
1998-1996: Pre-Vent Non-Locking Fuel Cap .....	10819		2001: Flex Fuel Regular Fuel Cap .....	10838Y	
1998-1996: Regular Locking Fuel Cap .....	10591		2001: Flex Fuel Regular Locking Fuel Cap .....	10508Y	
1998-1996: Pre-Vent Locking Fuel Cap .....	10501		2001: Oil Filler Cap .....	10111	
1998-1996: Oil Filler Cap .....	10066		2000: Lev-R-Vent Radiator Cap .....	10331	16
<b>V-6 3.6 L</b>			2000: OE Type Radiator Cap .....	10231	16
2012-2011: OE Equivalent Fuel Cap .....	10838		2000: OE Equivalent Fuel Cap .....	10838	
2012-2011: Flex Fuel Regular Fuel Cap .....	10838Y		2000: Flex Fuel Regular Fuel Cap .....	10838Y	
2012-2011: Regular Locking Fuel Cap .....	10508		2000: Regular Locking Fuel Cap .....	10508	
2012-2011: Flex Fuel Regular Locking Fuel Cap .....	10508Y		2000: Flex Fuel Regular Locking Fuel Cap .....	10508Y	
<b>V-6 3.8 L</b>			2000: Oil Filler Cap .....	10111	
2010-2000: Lev-R-Vent Radiator Cap .....	10331	16	<b>Daewoo</b>		
2010-2000: OE Type Radiator Cap .....	10231	16	<b>Lanos</b>		
2010-2000: OE Equivalent Fuel Cap .....	10838		<b>4-Cyl. 1.6 L</b>		
2010-2000: Regular Locking Fuel Cap .....	10508		2002-1999: OE Type Radiator Cap .....	10261	20
2010-2000: Oil Filler Cap .....	10111		2002-1999: OE Equivalent Fuel Cap .....	10834	
1999: Lev-R-Vent Radiator Cap .....	10331	16	2002-1999: Regular Locking Fuel Cap .....	10504	
1999: OE Type Radiator Cap .....	10231	16	<b>Leganza</b>		
1999: OE Equivalent Fuel Cap; Nov. 1, 1998 & Newer .....	10838		<b>4-Cyl. 2.2 L</b>		
1999: Regular Locking Fuel Cap; Nov. 1, 1998 & Newer .....	10508		2002-1999: OE Type Radiator Cap .....	10261	20
1999: OE Equivalent Fuel Cap; Oct. 31, 1998 & Older .....	10817		2002-1999: OE Equivalent Fuel Cap .....	10834	
1999: Pre-Vent Non-Locking Fuel Cap; Oct. 31, 1998 & Older ...	10819		2002-1999: Regular Locking Fuel Cap .....	10504	
1999: Regular Locking Fuel Cap; Oct. 31, 1998 & Older .....	10591		2002-1999: Oil Filler Cap .....	10140	
1999: Pre-Vent Locking Fuel Cap; Oct. 31, 1998 & Older .....	10501		<b>Nubira</b>		
1999: Oil Filler Cap .....	10111		<b>4-Cyl. 2.0 L</b>		
1998-1995: Lev-R-Vent Radiator Cap .....	10331	16	2002-1999: OE Type Radiator Cap .....	10261	20
1998-1995: OE Type Radiator Cap .....	10231	16	2002-1999: OE Equivalent Fuel Cap .....	10834	
1998-1995: OE Equivalent Fuel Cap .....	10817		2002-1999: Regular Locking Fuel Cap .....	10504	
1998-1995: Pre-Vent Non-Locking Fuel Cap .....	10819		2002-1999: Oil Filler Cap .....	10140	
1998-1995: Regular Locking Fuel Cap .....	10591		<b>Dodge</b>		
1998-1995: Pre-Vent Locking Fuel Cap .....	10501		<b>Avenger</b>		
1998-1995: Oil Filler Cap .....	10066		<b>4-Cyl. 2.0 L</b>		
<b>V-6 4.0 L</b>			1999-1998: Lev-R-Vent Radiator Cap .....	✓10333	16
2010: Lev-R-Vent Radiator Cap .....	10331	16	1999-1998: OE Type Radiator Cap .....	10233	16
2010: OE Type Radiator Cap .....	10231	16	1999-1998: OE Equivalent Fuel Cap .....	10817	
2010: OE Equivalent Fuel Cap .....	10838		1999-1998: Pre-Vent Non-Locking Fuel Cap .....	10819	
2010: Regular Locking Fuel Cap .....	10508		1999-1998: Regular Locking Fuel Cap .....	10591	
2009: Lev-R-Vent Radiator Cap .....	10331	16	1999-1998: Pre-Vent Locking Fuel Cap .....	10501	
2009: OE Type Radiator Cap .....	10231	16	1999-1998: Oil Filler Cap .....	10111	
2009: OE Equivalent Fuel Cap .....	10838		1997-1996: Lev-R-Vent Radiator Cap .....	✓10333	16
2009: Regular Locking Fuel Cap .....	10508		1997-1996: OE Type Radiator Cap .....	10233	16
2009: Oil Filler Cap .....	10148		1997-1996: OE Equivalent Fuel Cap .....	10817	
2008: Lev-R-Vent Radiator Cap .....	10331	16	1997-1996: Pre-Vent Non-Locking Fuel Cap .....	10819	
2008: OE Type Radiator Cap .....	10231	16	1997-1996: Regular Locking Fuel Cap .....	10591	
2008: OE Equivalent Fuel Cap .....	10838		1997-1996: Pre-Vent Locking Fuel Cap .....	10501	
2008: Regular Locking Fuel Cap .....	10508		1997-1996: Oil Filler Cap .....	10088	
<b>Voyager</b>			1995: Lev-R-Vent Radiator Cap .....	✓10333	16
<b>4-Cyl. 2.4 L</b>			1995: OE Type Radiator Cap .....	10233	16
2003-2000: Lev-R-Vent Radiator Cap .....	10331	16	1995: OE Equivalent Fuel Cap .....	10817	
2003-2000: OE Type Radiator Cap .....	10231	16	1995: Pre-Vent Non-Locking Fuel Cap .....	10819	
2003-2000: OE Equivalent Fuel Cap .....	10838		1995: Regular Locking Fuel Cap .....	10591	
2003-2000: Regular Locking Fuel Cap .....	10508		1995: Pre-Vent Locking Fuel Cap .....	10501	
2003-2000: Oil Filler Cap .....	10111		1995: Oil Filler Cap .....	10111	
<b>V-6 3.0 L</b>			<b>4-Cyl. 2.4 L</b>		
2000: Lev-R-Vent Radiator Cap .....	10331	16	2012-2011: OE Equivalent Fuel Cap .....	10838	
2000: OE Type Radiator Cap .....	10231	16	2012-2011: Regular Locking Fuel Cap .....	10508	
2000: OE Equivalent Fuel Cap .....	10838		2010: OE Equivalent Fuel Cap .....	10838	
2000: Regular Locking Fuel Cap .....	10508		2010: Regular Locking Fuel Cap .....	10508	
2000: Oil Filler Cap .....	10088		2010: Oil Filler Cap .....	10111	
<b>V-6 3.3 L</b>			2009-2008: Lev-R-Vent Radiator Cap .....	10330	16
2003-2002: Lev-R-Vent Radiator Cap .....	10331	16	2009-2008: OE Type Radiator Cap .....	10230	16
2003-2002: OE Type Radiator Cap .....	10231	16	2009-2008: OE Equivalent Fuel Cap .....	10838	
2003-2002: OE Equivalent Fuel Cap .....	10838		2009-2008: Regular Locking Fuel Cap .....	10508	
2003-2002: Flex Fuel Regular Fuel Cap .....	10838Y		2009-2008: Oil Filler Cap .....	10111	
2003-2002: Regular Locking Fuel Cap .....	10508		<b>V-6 2.5 L</b>		
2003-2002: Flex Fuel Regular Locking Fuel Cap .....	10508Y		<b>2000: Lev-R-Vent Radiator Cap .....</b>		
2003-2002: Oil Filler Cap .....	10111		10330 16		
2001: Lev-R-Vent Radiator Cap .....	10331	16			
2001: OE Type Radiator Cap .....	10231	16			

✓ Check Hood Clearance prior to installing this Cap.

## Caps for Passenger Cars and Light Trucks (1990 and Newer)

Application	Part Number	PSI	Application	Part Number	PSI
<b>Dodge - Continued</b>			<b>Dodge - Continued</b>		
<b>Avenger - Continued</b>			<b>B Series Van - Continued</b>		
<b>V-6 2.5 L - Continued</b>			<b>V-6 3.9 L - Continued</b>		
2000: OE Type Radiator Cap .....	10230	16	1998-1995: Regular Locking Fuel Cap .....	10591	
2000: OE Equivalent Fuel Cap .....	10834		1998-1995: Pre-Vent Locking Fuel Cap .....	10501	
2000: Regular Locking Fuel Cap .....	10504		1998-1995: Oil Filler Cap .....	10111	
2000: Oil Filler Cap .....	10088		1998-1995: Oil Breather Cap .....	10075	
1999-1995: Lev-R-Vent Radiator Cap .....	✓10327	13	<b>V-8 5.2 L; V-8 5.9 L</b>		
1999-1995: OE Type Radiator Cap .....	10227	13	2003-2000: Lev-R-Vent Radiator Cap .....	10334	18
1999-1995: OE Equivalent Fuel Cap .....	10817		2003-2000: OE Type Radiator Cap .....	10234	18
1999-1995: Pre-Vent Non-Locking Fuel Cap .....	10819		2003-2000: OE Equivalent Fuel Cap .....	10838	
1999-1995: Regular Locking Fuel Cap .....	10591		2003-2000: Regular Locking Fuel Cap .....	10508	
1999-1995: Pre-Vent Locking Fuel Cap .....	10501		2003-2000: Oil Filler Cap .....	10111	
1999-1995: Oil Filler Cap .....	10088		1999: Lev-R-Vent Radiator Cap .....	10334	18
<b>V-6 2.7 L</b>			1999: OE Type Radiator Cap .....	10234	18
2010: OE Equivalent Fuel Cap .....	10838		1999: OE Equivalent Fuel Cap .....	10817	
2010: Regular Locking Fuel Cap .....	10508		1999: Pre-Vent Non-Locking Fuel Cap .....	10819	
2010: Oil Filler Cap .....	10099		1999: Regular Locking Fuel Cap .....	10591	
2009-2008: Lev-R-Vent Radiator Cap .....	10330	16	1999: Pre-Vent Locking Fuel Cap .....	10501	
2009-2008: OE Type Radiator Cap .....	10230	16	1999: Oil Filler Cap .....	10111	
2009-2008: OE Equivalent Fuel Cap .....	10838		1998-1995: Lev-R-Vent Radiator Cap .....	10331	16
2009-2008: Regular Locking Fuel Cap .....	10508		1998-1995: OE Type Radiator Cap .....	10231	16
2009-2008: Flex Fuel Regular Fuel Cap .....	10838Y		1998-1995: OE Equivalent Fuel Cap .....	10817	
2009-2008: Flex Fuel Regular Locking Fuel Cap .....	10508Y		1998-1995: Pre-Vent Non-Locking Fuel Cap .....	10819	
2009-2008: Oil Filler Cap .....	10099		1998-1995: Regular Locking Fuel Cap .....	10591	
<b>V-6 3.5 L</b>			1998-1995: Pre-Vent Locking Fuel Cap .....	10501	
2010: OE Equivalent Fuel Cap .....	10838		1998-1995: Oil Filler Cap .....	10111	
2010: Regular Locking Fuel Cap .....	10508		1998-1995: Oil Breather Cap .....	10075	
2009-2008: Lev-R-Vent Radiator Cap .....	10330	16	<b>Caliber</b>		
2009-2008: OE Type Radiator Cap .....	10230	16	<b>4-Cyl. 1.8 L</b>		
2009-2008: OE Equivalent Fuel Cap .....	10838		2009-2007: Lev-R-Vent Radiator Cap .....	10330	16
2009-2008: Regular Locking Fuel Cap .....	10508		2009-2007: OE Type Radiator Cap .....	10230	16
2009-2008: Oil Filler Cap .....	10148		2009-2007: OE Equivalent Fuel Cap .....	10838	
<b>V-6 3.6 L</b>			2009-2007: Regular Locking Fuel Cap .....	10508	
2012: OE Equivalent Fuel Cap .....	10838		2009-2007: Oil Filler Cap .....	10111	
2012: Flex Fuel Regular Fuel Cap .....	10838Y		<b>4-Cyl. 2.0 L; 4-Cyl. 2.4 L</b>		
2012: Regular Locking Fuel Cap .....	10508		2011: OE Equivalent Fuel Cap .....	10838	
2012: Flex Fuel Regular Locking Fuel Cap .....	10508Y		2011: Regular Locking Fuel Cap .....	10508	
2011: OE Type Radiator Cap .....	10230	16	2010: OE Equivalent Fuel Cap .....	10838	
2011: Lev-R-Vent Radiator Cap .....	10330	16	2010: Regular Locking Fuel Cap .....	10508	
2011: OE Equivalent Fuel Cap .....	10838		2010: Oil Filler Cap .....	10111	
2011: Flex Fuel Regular Fuel Cap .....	10838Y		2009-2007: Lev-R-Vent Radiator Cap .....	10330	16
2011: Regular Locking Fuel Cap .....	10508		2009-2007: OE Type Radiator Cap .....	10230	16
2011: Flex Fuel Regular Locking Fuel Cap .....	10508Y		2009-2007: OE Equivalent Fuel Cap .....	10838	
<b>B Series Van</b>			2009-2007: Regular Locking Fuel Cap .....	10508	
<b>V-6 3.9 L</b>			2009-2007: Oil Filler Cap .....	10111	
2003: Lev-R-Vent Radiator Cap; W/H.D. Cool. ....	10334	18	<b>Caravan</b>		
2003: OE Type Radiator Cap; W/H.D. Cool. ....	10234	18	<b>4-Cyl. 2.4 L</b>		
2003: Lev-R-Vent Radiator Cap; W/O H.D. Cool. ....	10331	16	2007-2000: Lev-R-Vent Radiator Cap .....	10331	16
2003: OE Type Radiator Cap; W/O H.D. Cool. ....	10231	16	2007-2000: OE Type Radiator Cap .....	10231	16
2003: OE Equivalent Fuel Cap .....	10838		2007-2000: OE Equivalent Fuel Cap .....	10838	
2003: Regular Locking Fuel Cap .....	10508		2007-2000: Regular Locking Fuel Cap .....	10508	
2003: Oil Filler Cap .....	10111		2007-2000: Oil Filler Cap .....	10111	
2002: Lev-R-Vent Radiator Cap .....	10334	18	1999: Lev-R-Vent Radiator Cap .....	10331	16
2002: OE Type Radiator Cap .....	10234	18	1999: OE Type Radiator Cap .....	10231	16
2002: OE Equivalent Fuel Cap .....	10838		1999: OE Equivalent Fuel Cap; Nov. 1, 1998 & Newer .....	10838	
2002: Regular Locking Fuel Cap .....	10508		1999: Regular Locking Fuel Cap; Nov. 1, 1998 & Newer .....	10508	
2002: Oil Filler Cap .....	10111		1999: OE Equivalent Fuel Cap; Oct. 31, 1998 & Older .....	10817	
2001-2000: Lev-R-Vent Radiator Cap .....	10331	16	1999: Pre-Vent Non-Locking Fuel Cap; Oct. 31, 1998 & Older ...	10819	
2001-2000: OE Type Radiator Cap .....	10231	16	1999: Regular Locking Fuel Cap; Oct. 31, 1998 & Older .....	10591	
2001-2000: OE Equivalent Fuel Cap .....	10838		1999: Pre-Vent Locking Fuel Cap; Oct. 31, 1998 & Older .....	10501	
2001-2000: Regular Locking Fuel Cap .....	10508		1999: Oil Filler Cap .....	10111	
2001-2000: Oil Filler Cap .....	10111		1998-1996: Lev-R-Vent Radiator Cap .....	10331	16
1999: Lev-R-Vent Radiator Cap .....	10331	16	1998-1996: OE Type Radiator Cap .....	10231	16
1999: OE Type Radiator Cap .....	10231	16	1998-1996: OE Equivalent Fuel Cap .....	10817	
1999: OE Equivalent Fuel Cap .....	10817		1998-1996: Pre-Vent Non-Locking Fuel Cap .....	10819	
1999: Pre-Vent Non-Locking Fuel Cap .....	10819		1998-1996: Regular Locking Fuel Cap .....	10591	
1999: Regular Locking Fuel Cap .....	10591		1998-1996: Pre-Vent Locking Fuel Cap .....	10501	
1999: Pre-Vent Locking Fuel Cap .....	10501		1998-1996: Oil Filler Cap .....	10111	
1999: Oil Filler Cap .....	10111		<b>4-Cyl. 2.5 L</b>		
1998-1995: Lev-R-Vent Radiator Cap .....	10331	16	1995: Lev-R-Vent Radiator Cap .....	10331	16
1998-1995: OE Type Radiator Cap .....	10231	16	1995: OE Type Radiator Cap .....	10231	16
1998-1995: OE Equivalent Fuel Cap .....	10817		1995: OE Equivalent Fuel Cap .....	10817	
1998-1995: Pre-Vent Non-Locking Fuel Cap .....	10819				

✓ Check Hood Clearance prior to installing this Cap.

## Caps for Passenger Cars and Light Trucks (1990 and Newer)

Application	Part Number	PSI	Application	Part Number	PSI
<b>Dodge - Continued</b>			<b>Dodge - Continued</b>		
<b>Caravan - Continued</b>			<b>Caravan - Continued</b>		
<b>4-Cyl. 2.5 L - Continued</b>			<b>V-6 3.8 L - Continued</b>		
1995: Pre-Vent Non-Locking Fuel Cap .....	10819		1999: OE Equivalent Fuel Cap; Oct. 31, 1998 & Older .....	10817	
1995: Regular Locking Fuel Cap .....	10591		1999: Pre-Vent Non-Locking Fuel Cap; Oct. 31, 1998 & Older ...	10819	
1995: Pre-Vent Locking Fuel Cap .....	10501		1999: Regular Locking Fuel Cap; Oct. 31, 1998 & Older .....	10591	
1995: Oil Filler Cap .....	10111		1999: Pre-Vent Locking Fuel Cap; Oct. 31, 1998 & Older .....	10501	
<b>V-6 3.0 L</b>			1999: Oil Filler Cap .....	10111	
2000: Lev-R-Vent Radiator Cap .....	10331	16	1998-1996: Lev-R-Vent Radiator Cap .....	10331	16
2000: OE Type Radiator Cap .....	10231	16	1998-1996: OE Type Radiator Cap .....	10231	16
2000: OE Equivalent Fuel Cap .....	10838		1998-1996: OE Equivalent Fuel Cap .....	10817	
2000: Flex Fuel Regular Fuel Cap .....	10838Y		1998-1996: Pre-Vent Non-Locking Fuel Cap .....	10819	
2000: Regular Locking Fuel Cap .....	10508		1998-1996: Regular Locking Fuel Cap .....	10591	
2000: Flex Fuel Regular Locking Fuel Cap .....	10508Y		1998-1996: Pre-Vent Locking Fuel Cap .....	10501	
2000: Oil Filler Cap .....	10088		1998-1996: Oil Filler Cap .....	10066	
1999: Lev-R-Vent Radiator Cap .....	10331	16	<b>Challenger</b>		
1999: OE Type Radiator Cap .....	10231	16	<b>V-6 3.5 L</b>		
1999: OE Equivalent Fuel Cap; Nov. 1, 1998 & Newer .....	10838		2010: Lev-R-Vent Radiator Cap .....	10334	18
1999: Regular Locking Fuel Cap; Nov. 1, 1998 & Newer .....	10508		2010: OE Type Radiator Cap .....	10234	18
1999: OE Equivalent Fuel Cap; Oct. 31, 1998 & Older .....	10817		2010: OE Equivalent Fuel Cap .....	10838	
1999: Pre-Vent Non-Locking Fuel Cap; Oct. 31, 1998 & Older ...	10819		2010: Regular Locking Fuel Cap .....	10508	
1999: Regular Locking Fuel Cap; Oct. 31, 1998 & Older .....	10591		2010: Oil Filler Cap .....	10111	
1999: Pre-Vent Locking Fuel Cap; Oct. 31, 1998 & Older .....	10501		2009: Lev-R-Vent Radiator Cap .....	10334	18
1999: Oil Filler Cap .....	10088		2009: OE Type Radiator Cap .....	10234	18
1998-1995: Lev-R-Vent Radiator Cap .....	10331	16	2009: OE Equivalent Fuel Cap .....	10838	
1998-1995: OE Type Radiator Cap .....	10231	16	2009: Regular Locking Fuel Cap .....	10508	
1998-1995: OE Equivalent Fuel Cap .....	10817		<b>V-6 3.6 L</b>		
1998-1995: Pre-Vent Non-Locking Fuel Cap .....	10819		2011: OE Type Radiator Cap .....	10230	16
1998-1995: Regular Locking Fuel Cap .....	10591		2011: Lev-R-Vent Radiator Cap .....	10330	16
1998-1995: Pre-Vent Locking Fuel Cap .....	10501		<b>V-8 5.7 L</b>		
1998-1995: Oil Filler Cap .....	10088		2011: OE Type Radiator Cap .....	10230	16
<b>V-6 3.3 L</b>			2011: Lev-R-Vent Radiator Cap .....	10330	16
2007: Lev-R-Vent Radiator Cap .....	10331	16	2010-2009: Lev-R-Vent Radiator Cap .....	10334	18
2007: OE Type Radiator Cap .....	10231	16	2010-2009: OE Type Radiator Cap .....	10234	18
2007: OE Equivalent Fuel Cap .....	10838		2010-2009: OE Equivalent Fuel Cap .....	10838	
2007: Flex Fuel Regular Fuel Cap .....	10838Y		2010-2009: Regular Locking Fuel Cap .....	10508	
2007: Regular Locking Fuel Cap .....	10508		2010-2009: Oil Filler Cap .....	10111	
2007: Flex Fuel Regular Locking Fuel Cap .....	10508Y		<b>V-8 6.1 L</b>		
2007: Oil Filler Cap .....	10111		2010-2008: Lev-R-Vent Radiator Cap .....	10334	18
2006: Lev-R-Vent Radiator Cap .....	10331	16	2010-2008: OE Type Radiator Cap .....	10234	18
2006: OE Type Radiator Cap .....	10231	16	2010-2008: OE Equivalent Fuel Cap .....	10838	
2006: OE Equivalent Fuel Cap .....	10838		2010-2008: Regular Locking Fuel Cap .....	10508	
2006: Regular Locking Fuel Cap .....	10508		2010-2008: Oil Filler Cap .....	10111	
2006: Oil Filler Cap .....	10111		<b>V-8 6.4 L</b>		
2005-2000: Lev-R-Vent Radiator Cap .....	10331	16	2011: OE Type Radiator Cap .....	10230	16
2005-2000: OE Type Radiator Cap .....	10231	16	2011: Lev-R-Vent Radiator Cap .....	10330	16
2005-2000: OE Equivalent Fuel Cap .....	10838		<b>Charger</b>		
2005-2000: Flex Fuel Regular Fuel Cap .....	10838Y		<b>V-6 2.7 L</b>		
2005-2000: Regular Locking Fuel Cap .....	10508		2010: Lev-R-Vent Radiator Cap .....	10334	18
2005-2000: Flex Fuel Regular Locking Fuel Cap .....	10508Y		2010: OE Type Radiator Cap .....	10234	18
2005-2000: Oil Filler Cap .....	10111		2010: OE Equivalent Fuel Cap .....	10838	
1999: Lev-R-Vent Radiator Cap .....	10331	16	2010: Regular Locking Fuel Cap .....	10508	
1999: OE Type Radiator Cap .....	10231	16	2010: Oil Filler Cap .....	10111	
1999: OE Equivalent Fuel Cap; Nov. 1, 1998 & Newer .....	10838		2009-2006: Lev-R-Vent Radiator Cap .....	10334	18
1999: Flex Fuel Regular Fuel Cap; Nov. 1, 1998 & Newer .....	10838Y		2009-2006: OE Type Radiator Cap .....	10234	18
1999: Regular Locking Fuel Cap; Nov. 1, 1998 & Newer .....	10508		2009-2006: OE Equivalent Fuel Cap .....	10838	
1999: Flex Fuel Regular Locking Fuel Cap; Nov. 1, 1998 & Newer .....	10508Y		2009-2006: Regular Locking Fuel Cap .....	10508	
1999: OE Equivalent Fuel Cap; Oct. 31, 1998 & Older .....	10817		2009-2006: Oil Filler Cap .....	10099	
1999: Pre-Vent Non-Locking Fuel Cap; Oct. 31, 1998 & Older ...	10819		<b>V-6 3.5 L</b>		
1999: Regular Locking Fuel Cap; Oct. 31, 1998 & Older .....	10591		2010: Lev-R-Vent Radiator Cap .....	10334	18
1999: Pre-Vent Locking Fuel Cap; Oct. 31, 1998 & Older .....	10501		2010: OE Type Radiator Cap .....	10234	18
1999: Oil Filler Cap .....	10111		2010: OE Equivalent Fuel Cap .....	10838	
1998-1995: Lev-R-Vent Radiator Cap .....	10331	16	2010: Regular Locking Fuel Cap .....	10508	
1998-1995: OE Type Radiator Cap .....	10231	16	2010: Oil Filler Cap .....	10111	
1998-1995: OE Equivalent Fuel Cap .....	10817		2009-2007: Lev-R-Vent Radiator Cap .....	10334	18
1998-1995: Pre-Vent Non-Locking Fuel Cap .....	10819		2009-2007: OE Type Radiator Cap .....	10234	18
1998-1995: Regular Locking Fuel Cap .....	10591		2009-2007: OE Equivalent Fuel Cap .....	10838	
1998-1995: Pre-Vent Locking Fuel Cap .....	10501		2009-2007: Regular Locking Fuel Cap .....	10508	
1998-1995: Oil Filler Cap .....	10066		2009-2007: Oil Filler Cap .....	10148	
<b>V-6 3.8 L</b>			2006: Lev-R-Vent Radiator Cap .....	10334	18
1999: Lev-R-Vent Radiator Cap .....	10331	16	2006: OE Type Radiator Cap .....	10234	18
1999: OE Type Radiator Cap .....	10231	16	2006: OE Equivalent Fuel Cap .....	10838	
1999: OE Equivalent Fuel Cap; Nov. 1, 1998 & Newer .....	10838		2006: Regular Locking Fuel Cap .....	10508	
1999: Regular Locking Fuel Cap; Nov. 1, 1998 & Newer .....	10508		2006: Oil Filler Cap .....	10111	

## Caps for Passenger Cars and Light Trucks (1990 and Newer)

Application	Part Number	PSI	Application	Part Number	PSI
<b>Dodge - Continued</b>			<b>Dodge - Continued</b>		
<b>Charger - Continued</b>			<b>Dakota - Continued</b>		
<b>V-6 3.5 L - Continued</b>			<b>V-6 3.9 L - Continued</b>		
2006; Regular Locking Fuel Cap .....	10508		1998; OE Type Radiator Cap .....	10231	16
2006; Oil Filler Cap .....	10111		1998; OE Equivalent Fuel Cap .....	10817	
<b>V-8 5.7 L; V-8 6.1 L</b>			1998; Pre-Vent Non-Locking Fuel Cap .....	10819	
2010-2006; Lev-R-Vent Radiator Cap .....	10334	18	1998; Regular Locking Fuel Cap .....	10591	
2010-2006; OE Type Radiator Cap .....	10234	18	1998; Pre-Vent Locking Fuel Cap .....	10501	
2010-2006; OE Equivalent Fuel Cap .....	10838		1998; Oil Filler Cap .....	10111	
2010-2006; Regular Locking Fuel Cap .....	10508		1997-1995; Lev-R-Vent Radiator Cap .....	10331	16
2010-2006; Oil Filler Cap .....	10111		1997-1995; OE Type Radiator Cap .....	10231	16
<b>Dakota</b>			1997-1995; OE Equivalent Fuel Cap .....	10817	
<b>4-Cyl. 2.5 L</b>			1997-1995; Pre-Vent Non-Locking Fuel Cap .....	10819	
2002; Lev-R-Vent Radiator Cap .....	10335	20	1997-1995; Regular Locking Fuel Cap .....	10591	
2002; OE Type Radiator Cap .....	10235	20	1997-1995; Pre-Vent Locking Fuel Cap .....	10501	
2002; OE Equivalent Fuel Cap .....	10838		1997-1995; Oil Filler Cap .....	10111	
2002; Regular Locking Fuel Cap .....	10508		1997-1995; Oil Breather Cap .....	10075	
2002; Oil Filler Cap .....	10066		<b>V-8 4.7 L</b>		
2001-2000; Lev-R-Vent Radiator Cap .....	10334	18	2011; Lev-R-Vent Radiator Cap .....	10330	16
2001-2000; OE Type Radiator Cap .....	10234	18	2011; OE Type Radiator Cap .....	10230	16
2001-2000; OE Equivalent Fuel Cap .....	10838		2011; OE Equivalent Fuel Cap .....	10838	
2001-2000; Regular Locking Fuel Cap .....	10508		2011; Flex Fuel Regular Fuel Cap .....	10838Y	
2001-2000; Oil Filler Cap .....	10066		2011; Regular Locking Fuel Cap .....	10508	
1999-1995; Lev-R-Vent Radiator Cap .....	10331	16	2011; Flex Fuel Regular Locking Fuel Cap .....	10508Y	
1999-1995; OE Type Radiator Cap .....	10231	16	2011; Oil Filler Cap .....	10120	
1999-1995; OE Equivalent Fuel Cap .....	10817		2010; OE Equivalent Fuel Cap .....	10838	
1999-1995; Pre-Vent Non-Locking Fuel Cap .....	10819		2010; Flex Fuel Regular Fuel Cap .....	10838Y	
1999-1995; Regular Locking Fuel Cap .....	10591		2010; Regular Locking Fuel Cap .....	10508	
1999-1995; Pre-Vent Locking Fuel Cap .....	10501		2010; Flex Fuel Regular Locking Fuel Cap .....	10508Y	
1999-1995; Oil Filler Cap .....	10066		2010; Oil Filler Cap .....	10117	
<b>V-6 3.7 L</b>			2009; Lev-R-Vent Radiator Cap .....	10330	16
2011; Lev-R-Vent Radiator Cap .....	10330	16	2009; OE Type Radiator Cap .....	10230	16
2011; OE Type Radiator Cap .....	10230	16	2009; OE Equivalent Fuel Cap .....	10838	
2011; OE Equivalent Fuel Cap .....	10838		2009; Regular Locking Fuel Cap .....	10508	
2011; Regular Locking Fuel Cap .....	10508		2009; Flex Fuel Regular Fuel Cap .....	10838Y	
2011; Oil Filler Cap .....	10120		2009; Flex Fuel Regular Locking Fuel Cap .....	10508Y	
2010; OE Equivalent Fuel Cap .....	10838		2009; Oil Filler Cap .....	10120	
2010; Regular Locking Fuel Cap .....	10508		2008; Lev-R-Vent Radiator Cap .....	10330	16
2009; OE Equivalent Fuel Cap .....	10838		2008; OE Type Radiator Cap .....	10230	16
2009; Regular Locking Fuel Cap .....	10508		2008; OE Equivalent Fuel Cap .....	10838	
2009; Oil Filler Cap .....	10120		2008; Regular Locking Fuel Cap .....	10508	
2008; Lev-R-Vent Radiator Cap .....	10330	16	2008; Flex Fuel Regular Fuel Cap .....	10838Y	
2008; OE Type Radiator Cap .....	10230	16	2008; Flex Fuel Regular Locking Fuel Cap .....	10508Y	
2008; OE Equivalent Fuel Cap .....	10838		2007; Lev-R-Vent Radiator Cap .....	10330	16
2008; Regular Locking Fuel Cap .....	10508		2007; OE Type Radiator Cap .....	10230	16
2007-2005; Lev-R-Vent Radiator Cap .....	10330	16	2007; OE Equivalent Fuel Cap; Eng. VIN N, J .....	10838	
2007-2005; OE Type Radiator Cap .....	10230	16	2007; Regular Locking Fuel Cap; Eng. VIN N, J .....	10508	
2007-2005; OE Equivalent Fuel Cap .....	10838		2007; Flex Fuel Regular Fuel Cap; Eng. VIN P .....	10838Y	
2007-2005; Regular Locking Fuel Cap .....	10508		2007; Flex Fuel Regular Locking Fuel Cap; Eng. VIN P .....	10508Y	
2007-2005; Oil Filler Cap .....	10120		2007; Oil Filler Cap .....	10120	
2004; Lev-R-Vent Radiator Cap .....	10335	20	2006-2005; Lev-R-Vent Radiator Cap .....	10330	16
2004; OE Type Radiator Cap .....	10235	20	2006-2005; OE Type Radiator Cap .....	10230	16
2004; OE Equivalent Fuel Cap .....	10838		2006-2005; OE Equivalent Fuel Cap .....	10838	
2004; Regular Locking Fuel Cap .....	10508		2006-2005; Regular Locking Fuel Cap .....	10508	
2004; Oil Filler Cap .....	10120		2006-2005; Oil Filler Cap .....	10120	
<b>V-6 3.9 L</b>			2004-2001; Lev-R-Vent Radiator Cap .....	10335	20
2003-2001; Lev-R-Vent Radiator Cap .....	10335	20	2004-2001; OE Type Radiator Cap .....	10235	20
2003-2001; OE Type Radiator Cap .....	10235	20	2004-2001; OE Equivalent Fuel Cap .....	10838	
2003-2001; OE Equivalent Fuel Cap .....	10838		2004-2001; Regular Locking Fuel Cap .....	10508	
2003-2001; Regular Locking Fuel Cap .....	10508		2004-2001; Oil Filler Cap .....	10120	
2003-2001; Oil Filler Cap .....	10111		2000; Lev-R-Vent Radiator Cap .....	10334	18
2000; Lev-R-Vent Radiator Cap .....	10334	18	2000; OE Type Radiator Cap .....	10234	18
2000; OE Type Radiator Cap .....	10234	18	2000; OE Equivalent Fuel Cap .....	10838	
2000; OE Equivalent Fuel Cap .....	10838		2000; Regular Locking Fuel Cap .....	10508	
2000; Regular Locking Fuel Cap .....	10508		2000; Oil Filler Cap .....	10120	
2000; Oil Filler Cap .....	10111		<b>V-8 5.2 L</b>		
1999; Lev-R-Vent Radiator Cap .....	10330	16	1999; Lev-R-Vent Radiator Cap .....	10330	16
1999; OE Type Radiator Cap .....	10230	16	1999; OE Type Radiator Cap .....	10230	16
1999; OE Equivalent Fuel Cap .....	10817		1999; OE Equivalent Fuel Cap .....	10817	
1999; Pre-Vent Non-Locking Fuel Cap .....	10819		1999; Pre-Vent Non-Locking Fuel Cap .....	10819	
1999; Regular Locking Fuel Cap .....	10591		1999; Regular Locking Fuel Cap .....	10591	
1999; Pre-Vent Locking Fuel Cap .....	10501		1999; Pre-Vent Locking Fuel Cap .....	10501	
1999; Oil Filler Cap .....	10111		1999; Oil Filler Cap .....	10111	
1998; Lev-R-Vent Radiator Cap .....	10331	16	1998; Lev-R-Vent Radiator Cap .....	10331	16
1998; OE Type Radiator Cap .....	10231	16	1998; OE Type Radiator Cap .....	10231	16

## Caps for Passenger Cars and Light Trucks (1990 and Newer)

Application	Part Number	PSI	Application	Part Number	PSI
<b>Dodge - Continued</b>			<b>Dodge - Continued</b>		
<b>Dakota - Continued</b>			<b>Durango - Continued</b>		
<b>V-8 5.2 L - Continued</b>			<b>V-8 4.7 L - Continued</b>		
1998; OE Equivalent Fuel Cap .....	10817		2009-2008; Flex Fuel Regular Locking Fuel Cap .....	10508Y	
1998; Pre-Vent Non-Locking Fuel Cap .....	10819		2009-2008; Oil Filler Cap .....	10120	
1998; Regular Locking Fuel Cap .....	10591		2007-2006; Lev-R-Vent Radiator Cap .....	10335	20
1998; Pre-Vent Locking Fuel Cap .....	10501		2007-2006; OE Type Radiator Cap .....	10235	20
1998; Oil Filler Cap .....	10111		2007-2006; OE Equivalent Fuel Cap; Eng. VIN N, P .....	10838	
1997-1995; Lev-R-Vent Radiator Cap .....	10331	16	2007-2006; Regular Locking Fuel Cap; Eng. VIN N, P .....	10508	
1997-1995; OE Type Radiator Cap .....	10231	16	2007-2006; Flex Fuel Regular Fuel Cap; Eng. VIN P .....	10838Y	
1997-1995; OE Equivalent Fuel Cap .....	10817		2007-2006; Flex Fuel Regular Locking Fuel Cap; Eng. VIN P .....	10508Y	
1997-1995; Pre-Vent Non-Locking Fuel Cap .....	10819		2007-2006; Oil Filler Cap .....	10120	
1997-1995; Regular Locking Fuel Cap .....	10591		2005-2001; Lev-R-Vent Radiator Cap .....	10335	20
1997-1995; Pre-Vent Locking Fuel Cap .....	10501		2005-2001; OE Type Radiator Cap .....	10235	20
1997-1995; Oil Filler Cap .....	10111		2005-2001; OE Equivalent Fuel Cap .....	10838	
1997-1995; Oil Breather Cap .....	10075		2005-2001; Regular Locking Fuel Cap .....	10508	
<b>V-8 5.9 L</b>			2005-2001; Oil Filler Cap .....	10120	
2003-2001; Lev-R-Vent Radiator Cap .....	10335	20	2000; Lev-R-Vent Radiator Cap .....	10334	18
2003-2001; OE Type Radiator Cap .....	10235	20	2000; OE Type Radiator Cap .....	10234	18
2003-2001; OE Equivalent Fuel Cap .....	10838		2000; OE Equivalent Fuel Cap .....	10838	
2003-2001; Regular Locking Fuel Cap .....	10508		2000; Regular Locking Fuel Cap .....	10508	
2003-2001; Oil Filler Cap .....	10111		2000; Oil Filler Cap .....	10120	
2000; Lev-R-Vent Radiator Cap .....	10334	18	<b>V-8 5.2 L</b>		
2000; OE Type Radiator Cap .....	10234	18	2000; Lev-R-Vent Radiator Cap .....	10334	18
2000; OE Equivalent Fuel Cap .....	10838		2000; OE Type Radiator Cap .....	10234	18
2000; Regular Locking Fuel Cap .....	10508		2000; OE Equivalent Fuel Cap .....	10838	
2000; Oil Filler Cap .....	10111		2000; Regular Locking Fuel Cap .....	10508	
1999; Lev-R-Vent Radiator Cap .....	10330	16	2000; Oil Filler Cap .....	10111	
1999; OE Type Radiator Cap .....	10230	16	1999; Lev-R-Vent Radiator Cap .....	10330	16
1999; OE Equivalent Fuel Cap .....	10817		1999; OE Type Radiator Cap .....	10230	16
1999; Pre-Vent Non-Locking Fuel Cap .....	10819		1999; OE Equivalent Fuel Cap .....	10817	
1999; Regular Locking Fuel Cap .....	10591		1999; Pre-Vent Non-Locking Fuel Cap .....	10819	
1999; Pre-Vent Locking Fuel Cap .....	10501		1999; Regular Locking Fuel Cap .....	10591	
1999; Oil Filler Cap .....	10111		1999; Pre-Vent Locking Fuel Cap .....	10501	
1998; Lev-R-Vent Radiator Cap .....	10331	16	1999; Oil Filler Cap .....	10111	
1998; OE Type Radiator Cap .....	10231	16	1998; Lev-R-Vent Radiator Cap .....	10331	16
1998; OE Equivalent Fuel Cap .....	10817		1998; OE Type Radiator Cap .....	10231	16
1998; Pre-Vent Non-Locking Fuel Cap .....	10819		1998; OE Equivalent Fuel Cap .....	10817	
1998; Regular Locking Fuel Cap .....	10591		1998; Pre-Vent Non-Locking Fuel Cap .....	10819	
1998; Pre-Vent Locking Fuel Cap .....	10501		1998; Regular Locking Fuel Cap .....	10591	
1998; Oil Filler Cap .....	10111		1998; Pre-Vent Locking Fuel Cap .....	10501	
<b>Durango</b>			1998; Oil Filler Cap .....	10111	
<b>V-6 3.6 L</b>			<b>V-8 5.7 L</b>		
2012-2011; OE Equivalent Fuel Cap .....	10838		2012; OE Equivalent Fuel Cap .....	10838	
2012-2011; Flex Fuel Regular Fuel Cap .....	10838Y		2012; Flex Fuel Regular Fuel Cap .....	10838Y	
2012-2011; Regular Locking Fuel Cap .....	10508		2012; Regular Locking Fuel Cap .....	10508	
2012-2011; Flex Fuel Regular Locking Fuel Cap .....	10508Y		2012; Flex Fuel Regular Locking Fuel Cap .....	10508Y	
<b>V-6 3.7 L</b>			2011; OE Equivalent Fuel Cap .....	10838	
2009-2004; Lev-R-Vent Radiator Cap .....	10335	20	2011; Regular Locking Fuel Cap .....	10508	
2009-2004; OE Type Radiator Cap .....	10235	20	2009; Lev-R-Vent Radiator Cap .....	10335	20
2009-2004; OE Equivalent Fuel Cap .....	10838		2009; OE Type Radiator Cap .....	10235	20
2009-2004; Regular Locking Fuel Cap .....	10508		2009; OE Equivalent Fuel Cap .....	10838	
2009-2004; Oil Filler Cap .....	10120		2009; Regular Locking Fuel Cap .....	10508	
<b>V-6 3.9 L</b>			2009; Oil Filler Cap .....	10111	
1999; Lev-R-Vent Radiator Cap .....	10330	16	2008-2004; Lev-R-Vent Radiator Cap .....	10335	20
1999; OE Type Radiator Cap .....	10230	16	2008-2004; OE Type Radiator Cap .....	10235	20
1999; OE Equivalent Fuel Cap .....	10817		2008-2004; OE Equivalent Fuel Cap .....	10838	
1999; Pre-Vent Non-Locking Fuel Cap .....	10819		2008-2004; Regular Locking Fuel Cap .....	10508	
1999; Regular Locking Fuel Cap .....	10591		2008-2004; Oil Filler Cap .....	10145	
1999; Pre-Vent Locking Fuel Cap .....	10501		<b>V-8 5.7 L Electric Assist</b>		
1999; Oil Filler Cap .....	10111		2009; Lev-R-Vent Radiator Cap .....	10335	20
1998; Lev-R-Vent Radiator Cap .....	10331	16	2009; OE Type Radiator Cap .....	10235	20
1998; OE Type Radiator Cap .....	10231	16	2009; OE Equivalent Fuel Cap .....	10838	
1998; OE Equivalent Fuel Cap .....	10817		2009; Regular Locking Fuel Cap .....	10508	
1998; Pre-Vent Non-Locking Fuel Cap .....	10819		<b>V-8 5.9 L</b>		
1998; Regular Locking Fuel Cap .....	10591		2003-2001; Lev-R-Vent Radiator Cap .....	10335	20
1998; Pre-Vent Locking Fuel Cap .....	10501		2003-2001; OE Type Radiator Cap .....	10235	20
1998; Oil Filler Cap .....	10111		2003-2001; OE Equivalent Fuel Cap .....	10838	
<b>V-8 4.7 L</b>			2003-2001; Regular Locking Fuel Cap .....	10508	
2009-2008; Lev-R-Vent Radiator Cap .....	10335	20	2003-2001; Oil Filler Cap .....	10111	
2009-2008; OE Type Radiator Cap .....	10235	20	2000; Lev-R-Vent Radiator Cap .....	10334	18
2009-2008; OE Equivalent Fuel Cap .....	10838		2000; OE Type Radiator Cap .....	10234	18
2009-2008; Regular Locking Fuel Cap .....	10508		2000; OE Equivalent Fuel Cap .....	10838	
2009-2008; Flex Fuel Regular Fuel Cap .....	10838Y		2000; Regular Locking Fuel Cap .....	10508	
			2000; Oil Filler Cap .....	10111	

## Caps for Passenger Cars and Light Trucks (1990 and Newer)

Application	Part Number	PSI	Application	Part Number	PSI
<b>Dodge - Continued</b>			<b>Dodge - Continued</b>		
<b>Durango - Continued</b>			<b>Grand Caravan - Continued</b>		
<b>V-8 5.9 L - Continued</b>			<b>V-6 3.3 L - Continued</b>		
1999: Lev-R-Vent Radiator Cap .....	10330	16	2005: OE Type Radiator Cap .....	10231	16
1999: OE Type Radiator Cap .....	10230	16	2005: OE Equivalent Fuel Cap .....	10838	
1999: OE Equivalent Fuel Cap .....	10817		2005: Flex Fuel Regular Fuel Cap .....	10838Y	
1999: Pre-Vent Non-Locking Fuel Cap .....	10819		2005: Regular Locking Fuel Cap .....	10508	
1999: Regular Locking Fuel Cap .....	10591		2005: Flex Fuel Regular Locking Fuel Cap .....	10508Y	
1999: Pre-Vent Locking Fuel Cap .....	10501		2005: Oil Filler Cap .....	10111	
1999: Oil Filler Cap .....	10111		2004: Lev-R-Vent Radiator Cap .....	10331	16
1998: Lev-R-Vent Radiator Cap .....	10331	16	2004: OE Type Radiator Cap .....	10231	16
1998: OE Type Radiator Cap .....	10231	16	2004: OE Equivalent Fuel Cap .....	10838	
1998: OE Equivalent Fuel Cap .....	10817		2004: Regular Locking Fuel Cap .....	10508	
1998: Pre-Vent Non-Locking Fuel Cap .....	10819		2004: Oil Filler Cap .....	10111	
1998: Regular Locking Fuel Cap .....	10591		2003-2000: Lev-R-Vent Radiator Cap .....	10331	16
1998: Pre-Vent Locking Fuel Cap .....	10501		2003-2000: OE Type Radiator Cap .....	10231	16
1998: Oil Filler Cap .....	10111		2003-2000: OE Equivalent Fuel Cap .....	10838	
<b>Grand Caravan</b>			2003-2000: Flex Fuel Regular Fuel Cap .....	10838Y	
<b>4-Cyl. 2.4 L</b>			2003-2000: Regular Locking Fuel Cap .....	10508	
1997-1996: Lev-R-Vent Radiator Cap .....	10331	16	2003-2000: Flex Fuel Regular Locking Fuel Cap .....	10508Y	
1997-1996: OE Type Radiator Cap .....	10231	16	2003-2000: Oil Filler Cap .....	10111	
1997-1996: OE Equivalent Fuel Cap .....	10817		1999: Lev-R-Vent Radiator Cap .....	10331	16
1997-1996: Pre-Vent Non-Locking Fuel Cap .....	10819		1999: OE Type Radiator Cap .....	10231	16
1997-1996: Regular Locking Fuel Cap .....	10591		1999: OE Equivalent Fuel Cap; Nov. 1, 1998 & Newer .....	10838	
1997-1996: Pre-Vent Locking Fuel Cap .....	10501		1999: Flex Fuel Regular Fuel Cap; Nov. 1, 1998 & Newer .....	10838Y	
1997-1996: Oil Filler Cap .....	10111		1999: Regular Locking Fuel Cap; Nov. 1, 1998 & Newer .....	10508	
<b>V-6 3.0 L</b>			1999: Flex Fuel Regular Locking Fuel Cap; Nov. 1, 1998 & Newer .....	10508Y	
2000: Lev-R-Vent Radiator Cap .....	10331	16	1999: OE Equivalent Fuel Cap; Oct. 31, 1998 & Older .....	10817	
2000: OE Type Radiator Cap .....	10231	16	1999: Pre-Vent Non-Locking Fuel Cap; Oct. 31, 1998 & Older ...	10819	
2000: OE Equivalent Fuel Cap .....	10838		1999: Regular Locking Fuel Cap; Oct. 31, 1998 & Older .....	10591	
2000: Regular Locking Fuel Cap .....	10508		1999: Pre-Vent Locking Fuel Cap; Oct. 31, 1998 & Older .....	10501	
2000: Oil Filler Cap .....	10088		1999: Oil Filler Cap .....	10111	
1999: Lev-R-Vent Radiator Cap .....	10331	16	1998-1995: Lev-R-Vent Radiator Cap .....	10331	16
1999: OE Type Radiator Cap .....	10231	16	1998-1995: OE Type Radiator Cap .....	10231	16
1999: OE Equivalent Fuel Cap; Nov. 1, 1998 & Newer .....	10838		1998-1995: OE Equivalent Fuel Cap .....	10817	
1999: Regular Locking Fuel Cap; Nov. 1, 1998 & Newer .....	10508		1998-1995: Pre-Vent Non-Locking Fuel Cap .....	10819	
1999: OE Equivalent Fuel Cap; Oct. 31, 1998 & Older .....	10817		1998-1995: Regular Locking Fuel Cap .....	10591	
1999: Pre-Vent Non-Locking Fuel Cap; Oct. 31, 1998 & Older ...	10819		1998-1995: Pre-Vent Locking Fuel Cap .....	10501	
1999: Regular Locking Fuel Cap; Oct. 31, 1998 & Older .....	10591		1998-1995: Oil Filler Cap .....	10066	
1999: Pre-Vent Locking Fuel Cap; Oct. 31, 1998 & Older .....	10501		<b>V-6 3.6 L</b>		
1999: Oil Filler Cap .....	10088		2012-2011: OE Equivalent Fuel Cap .....	10838	
1998-1995: Lev-R-Vent Radiator Cap .....	10331	16	2012-2011: Flex Fuel Regular Fuel Cap .....	10838Y	
1998-1995: OE Type Radiator Cap .....	10231	16	2012-2011: Regular Locking Fuel Cap .....	10508	
1998-1995: OE Equivalent Fuel Cap .....	10817		2012-2011: Flex Fuel Regular Locking Fuel Cap .....	10508Y	
1998-1995: Pre-Vent Non-Locking Fuel Cap .....	10819		<b>V-6 3.8 L</b>		
1998-1995: Regular Locking Fuel Cap .....	10591		2010-2000: Lev-R-Vent Radiator Cap .....	10331	16
1998-1995: Pre-Vent Locking Fuel Cap .....	10501		2010-2000: OE Type Radiator Cap .....	10231	16
1998-1995: Oil Filler Cap .....	10088		2010-2000: OE Equivalent Fuel Cap .....	10838	
<b>V-6 3.3 L</b>			2010-2000: Regular Locking Fuel Cap .....	10508	
2010-2009: Lev-R-Vent Radiator Cap .....	10331	16	2010-2000: Oil Filler Cap .....	10111	
2010-2009: OE Type Radiator Cap .....	10231	16	1999: Lev-R-Vent Radiator Cap .....	10331	16
2010-2009: OE Equivalent Fuel Cap .....	10838		1999: OE Type Radiator Cap .....	10231	16
2010-2009: Regular Locking Fuel Cap .....	10508		1999: OE Equivalent Fuel Cap; Nov. 1, 1998 & Newer .....	10838	
2010-2009: Oil Filler Cap .....	10111		1999: Regular Locking Fuel Cap; Nov. 1, 1998 & Newer .....	10508	
2008: Lev-R-Vent Radiator Cap .....	10331	16	1999: OE Equivalent Fuel Cap; Oct. 31, 1998 & Older .....	10817	
2008: OE Type Radiator Cap .....	10231	16	1999: Pre-Vent Non-Locking Fuel Cap; Oct. 31, 1998 & Older ...	10819	
2008: OE Equivalent Fuel Cap .....	10838		1999: Regular Locking Fuel Cap; Oct. 31, 1998 & Older .....	10591	
2008: Regular Locking Fuel Cap .....	10508		1999: Pre-Vent Locking Fuel Cap; Oct. 31, 1998 & Older .....	10501	
2008: Flex Fuel Regular Fuel Cap .....	10838Y		1999: Oil Filler Cap .....	10111	
2008: Flex Fuel Regular Locking Fuel Cap .....	10508Y		1998-1996: Lev-R-Vent Radiator Cap .....	10331	16
2008: Oil Filler Cap .....	10111		1998-1996: OE Type Radiator Cap .....	10231	16
2007: Lev-R-Vent Radiator Cap .....	10331	16	1998-1996: OE Equivalent Fuel Cap .....	10817	
2007: OE Type Radiator Cap .....	10231	16	1998-1996: Pre-Vent Non-Locking Fuel Cap .....	10819	
2007: OE Equivalent Fuel Cap .....	10838		1998-1996: Regular Locking Fuel Cap .....	10591	
2007: Flex Fuel Regular Fuel Cap .....	10838Y		1998-1996: Pre-Vent Locking Fuel Cap .....	10501	
2007: Regular Locking Fuel Cap .....	10508		1998-1996: Oil Filler Cap .....	10066	
2007: Flex Fuel Regular Locking Fuel Cap .....	10508Y		1995: Lev-R-Vent Radiator Cap .....	10331	16
2007: Oil Filler Cap .....	10111		1995: OE Type Radiator Cap .....	10231	16
2006: Lev-R-Vent Radiator Cap .....	10331	16	1995: OE Equivalent Fuel Cap .....	10817	
2006: OE Type Radiator Cap .....	10231	16	1995: Pre-Vent Non-Locking Fuel Cap .....	10819	
2006: OE Equivalent Fuel Cap .....	10838		1995: Regular Locking Fuel Cap .....	10591	
2006: Regular Locking Fuel Cap .....	10508		1995: Pre-Vent Locking Fuel Cap .....	10501	
2006: Oil Filler Cap .....	10111		1995: Oil Filler Cap .....	10111	
2005: Lev-R-Vent Radiator Cap .....	10331	16			



## Caps for Passenger Cars and Light Trucks (1990 and Newer)

Application	Part Number	PSI	Application	Part Number	PSI
<b>Dodge - Continued</b>			<b>Dodge - Continued</b>		
<b>Grand Caravan - Continued</b>			<b>Journey - Continued</b>		
<b>V-6 4.0 L</b>			<b>4-Cyl. 2.4 L - Continued</b>		
2010; Lev-R-Vent Radiator Cap .....	10331	16	2010; Oil Filler Cap .....	10111	
2010; OE Type Radiator Cap .....	10231	16	2009; Lev-R-Vent Radiator Cap .....	10334	18
2010; OE Equivalent Fuel Cap .....	10838		2009; OE Type Radiator Cap .....	10234	18
2010; Regular Locking Fuel Cap .....	10508		2009; OE Equivalent Fuel Cap .....	10838	
2010; Oil Filler Cap .....	10111		2009; Regular Locking Fuel Cap .....	10508	
2009; Lev-R-Vent Radiator Cap .....	10331	16	2009; Oil Filler Cap .....	10111	
2009; OE Type Radiator Cap .....	10231	16	<b>V-6 3.5 L</b>		
2009; OE Equivalent Fuel Cap .....	10838		2010; Lev-R-Vent Radiator Cap .....	10330	16
2009; Regular Locking Fuel Cap .....	10508		2010; OE Type Radiator Cap .....	10230	16
2008; Lev-R-Vent Radiator Cap .....	10331	16	2010; OE Equivalent Fuel Cap .....	10838	
2008; OE Type Radiator Cap .....	10231	16	2010; Regular Locking Fuel Cap .....	10508	
2008; OE Equivalent Fuel Cap .....	10838		2009; Lev-R-Vent Radiator Cap .....	10330	16
2008; Regular Locking Fuel Cap .....	10508		2009; OE Type Radiator Cap .....	10230	16
2008; Oil Filler Cap .....	10148		2009; OE Equivalent Fuel Cap .....	10838	
<b>Intrepid</b>			2009; Regular Locking Fuel Cap .....	10508	
<b>V-6 2.7 L</b>			2009; Oil Filler Cap .....	10099	
2004-2000; Lev-R-Vent Radiator Cap .....	10330	16	<b>V-6 3.6 L</b>		
2004-2000; OE Type Radiator Cap .....	10230	16	2011; OE Type Radiator Cap .....	10230	16
2004-2000; OE Equivalent Fuel Cap .....	10838		2011; Lev-R-Vent Radiator Cap .....	10330	16
2004-2000; Regular Locking Fuel Cap .....	10508		2011; OE Equivalent Fuel Cap .....	10838	
2004-2000; Oil Filler Cap .....	10099		2011; Flex Fuel Regular Fuel Cap .....	10838Y	
1999-1998; Lev-R-Vent Radiator Cap .....	10330	16	2011; Regular Locking Fuel Cap .....	10508	
1999-1998; OE Type Radiator Cap .....	10230	16	2011; Flex Fuel Regular Locking Fuel Cap .....	10508Y	
1999-1998; OE Equivalent Fuel Cap .....	10817		<b>Magnum</b>		
1999-1998; Pre-Vent Non-Locking Fuel Cap .....	10819		<b>V-6 2.7 L</b>		
1999-1998; Regular Locking Fuel Cap .....	10591		2008-2006; Lev-R-Vent Radiator Cap .....	10334	18
1999-1998; Pre-Vent Locking Fuel Cap .....	10501		2008-2006; OE Type Radiator Cap .....	10234	18
1999-1998; Oil Filler Cap .....	10099		2008-2006; OE Equivalent Fuel Cap .....	10838	
<b>V-6 3.2 L</b>			2008-2006; Regular Locking Fuel Cap .....	10508	
2001-2000; Lev-R-Vent Radiator Cap .....	10330	16	2008-2006; Oil Filler Cap .....	10099	
2001-2000; OE Type Radiator Cap .....	10230	16	2005; Lev-R-Vent Radiator Cap .....	10334	18
2001-2000; OE Equivalent Fuel Cap .....	10838		2005; OE Type Radiator Cap .....	10234	18
2001-2000; Regular Locking Fuel Cap .....	10508		2005; OE Equivalent Fuel Cap .....	10838	
2001-2000; Oil Filler Cap .....	10111		2005; Regular Locking Fuel Cap .....	10508	
1999-1998; Lev-R-Vent Radiator Cap .....	10330	16	2005; Oil Filler Cap .....	10111	
1999-1998; OE Type Radiator Cap .....	10230	16	<b>V-6 3.5 L</b>		
1999-1998; OE Equivalent Fuel Cap .....	10817		2008-2007; Lev-R-Vent Radiator Cap .....	10334	18
1999-1998; Pre-Vent Non-Locking Fuel Cap .....	10819		2008-2007; OE Type Radiator Cap .....	10234	18
1999-1998; Regular Locking Fuel Cap .....	10591		2008-2007; OE Equivalent Fuel Cap .....	10838	
1999-1998; Pre-Vent Locking Fuel Cap .....	10501		2008-2007; Regular Locking Fuel Cap .....	10508	
1999-1998; Oil Filler Cap .....	10111		2008-2007; Oil Filler Cap .....	10148	
<b>V-6 3.3 L</b>			2006-2005; Lev-R-Vent Radiator Cap .....	10334	18
1997-1995; Lev-R-Vent Radiator Cap .....	10330	16	2006-2005; OE Type Radiator Cap .....	10234	18
1997-1995; OE Type Radiator Cap .....	10230	16	2006-2005; OE Equivalent Fuel Cap .....	10838	
1997-1995; OE Equivalent Fuel Cap .....	10817		2006-2005; Regular Locking Fuel Cap .....	10508	
1997-1995; Pre-Vent Non-Locking Fuel Cap .....	10819		2006-2005; Oil Filler Cap .....	10111	
1997-1995; Regular Locking Fuel Cap .....	10591		<b>V-8 5.7 L</b>		
1997-1995; Pre-Vent Locking Fuel Cap .....	10501		2008-2005; Lev-R-Vent Radiator Cap .....	10334	18
1997-1995; Oil Filler Cap .....	10066		2008-2005; OE Type Radiator Cap .....	10234	18
<b>V-6 3.5 L</b>			2008-2005; OE Equivalent Fuel Cap .....	10838	
2004-2000; Lev-R-Vent Radiator Cap .....	10330	16	2008-2005; Regular Locking Fuel Cap .....	10508	
2004-2000; OE Type Radiator Cap .....	10230	16	2008-2005; Oil Filler Cap .....	10111	
2004-2000; OE Equivalent Fuel Cap .....	10838		<b>V-8 6.1 L</b>		
2004-2000; Regular Locking Fuel Cap .....	10508		2008-2006; Lev-R-Vent Radiator Cap .....	10334	18
2004-2000; Oil Filler Cap .....	10111		2008-2006; OE Type Radiator Cap .....	10234	18
1997-1995; Lev-R-Vent Radiator Cap .....	10330	16	2008-2006; OE Equivalent Fuel Cap .....	10838	
1997-1995; OE Type Radiator Cap .....	10230	16	2008-2006; Regular Locking Fuel Cap .....	10508	
1997-1995; OE Equivalent Fuel Cap .....	10817		2008-2006; Oil Filler Cap .....	10111	
1997-1995; Pre-Vent Non-Locking Fuel Cap .....	10819		<b>Neon</b>		
1997-1995; Regular Locking Fuel Cap .....	10591		<b>4-Cyl. 2.0 L</b>		
1997-1995; Pre-Vent Locking Fuel Cap .....	10501		2005; Lev-R-Vent Radiator Cap .....	10334	18
1997-1995; Oil Filler Cap .....	10111		2005; OE Type Radiator Cap .....	10234	18
<b>Journey</b>			2005; OE Equivalent Fuel Cap .....	10838	
<b>4-Cyl. 2.4 L</b>			2005; Regular Locking Fuel Cap .....	10508	
2011; OE Equivalent Fuel Cap .....	10838		2005; Oil Filler Cap .....	10111	
2011; Regular Locking Fuel Cap .....	10508		2004-2000; Lev-R-Vent Radiator Cap .....	10330	16
2010; Lev-R-Vent Radiator Cap .....	10330	16	2004-2000; OE Type Radiator Cap .....	10230	16
2010; OE Type Radiator Cap .....	10230	16	2004-2000; OE Equivalent Fuel Cap .....	10838	
2010; OE Equivalent Fuel Cap .....	10838		2004-2000; Regular Locking Fuel Cap .....	10508	
2010; Regular Locking Fuel Cap .....	10508				

## Caps for Passenger Cars and Light Trucks (1990 and Newer)

Application	Part Number	PSI	Application	Part Number	PSI
<b>Dodge - Continued</b>			<b>Dodge - Continued</b>		
<b>Neon - Continued</b>			<b>Ram Series Pickup - Continued</b>		
<b>4-Cyl. 2.0 L - Continued</b>			<b>6-Cyl. 5.9 L Diesel - Continued</b>		
2004-2000: Oil Filler Cap .....	10111		2009-2000: OE Equivalent Fuel Cap .....	10838	
1999: Lev-R-Vent Radiator Cap .....	10330	16	2009-2000: Diesel Regular Non-Locking Fuel Cap .....	10838D	
1999: OE Type Radiator Cap .....	10230	16	2009-2000: Regular Locking Fuel Cap .....	10508	
1999: OE Equivalent Fuel Cap; Dec. 31, 1998 & Older .....	10817		2009-2000: Diesel Regular Locking Fuel Cap .....	10508D	
1999: Pre-Vent Non-Locking Fuel Cap; Dec. 31, 1998 & Older ..	10819		2009-2000: Oil Filler Cap .....	10111	
1999: Regular Locking Fuel Cap; Dec. 31, 1998 & Older .....	10591		1999: Lev-R-Vent Radiator Cap .....	10330	16
1999: Pre-Vent Locking Fuel Cap; Dec. 31, 1998 & Older .....	10501		1999: OE Type Radiator Cap .....	10230	16
1999: OE Equivalent Fuel Cap; Jan. 1 & Newer .....	10838		1999: OE Equivalent Fuel Cap .....	10817	
1999: Regular Locking Fuel Cap; Jan. 1 & Newer .....	10508		1999: Pre-Vent Non-Locking Fuel Cap .....	10819	
1999: Oil Filler Cap .....	10111		1999: Regular Locking Fuel Cap .....	10591	
1998: Lev-R-Vent Radiator Cap .....	10330	16	1999: Pre-Vent Locking Fuel Cap .....	10501	
1998: OE Type Radiator Cap .....	10230	16	1999: Diesel Pre-Vent Non-Locking Fuel Cap .....	10819D	
1998: OE Equivalent Fuel Cap .....	10817		1999: Diesel Regular Non-Locking Fuel Cap .....	10830D	
1998: Pre-Vent Non-Locking Fuel Cap .....	10819		1999: Diesel Only Pre-Vent Locking Fuel Cap .....	10501D	
1998: Regular Locking Fuel Cap .....	10591		1999: Diesel Regular Locking Fuel Cap .....	10591D	
1998: Pre-Vent Locking Fuel Cap .....	10501		1999: Oil Filler Cap .....	10136	
1998: Oil Filler Cap .....	10111		1998: Lev-R-Vent Radiator Cap .....	10330	16
1997: Lev-R-Vent Radiator Cap .....	10330	16	1998: OE Type Radiator Cap .....	10230	16
1997: OE Type Radiator Cap .....	10230	16	1998: OE Equivalent Fuel Cap .....	10817	
1997: OE Equivalent Fuel Cap .....	10817		1998: Pre-Vent Non-Locking Fuel Cap .....	10819	
1997: Pre-Vent Non-Locking Fuel Cap .....	10819		1998: Regular Locking Fuel Cap .....	10591	
1997: Regular Locking Fuel Cap .....	10591		1998: Pre-Vent Locking Fuel Cap .....	10501	
1997: Pre-Vent Locking Fuel Cap .....	10501		1998: Diesel Pre-Vent Non-Locking Fuel Cap .....	10819D	
1997: Oil Filler Cap; W/O Threaded Filler Neck .....	10088		1998: Diesel Regular Non-Locking Fuel Cap .....	10830D	
1997: Oil Filler Cap; W/Threaded Filler Neck .....	10111		1998: Diesel Only Pre-Vent Locking Fuel Cap .....	10501D	
1996-1995: Lev-R-Vent Radiator Cap .....	10330	16	1998: Diesel Regular Locking Fuel Cap .....	10591D	
1996-1995: OE Type Radiator Cap .....	10230	16	1999: Oil Filler Cap .....	10111	
1996-1995: OE Equivalent Fuel Cap .....	10817		1998: Oil Filler Cap; Eng. VIN D .....	10136	
1996-1995: Pre-Vent Non-Locking Fuel Cap .....	10819		1997-1995: Lev-R-Vent Radiator Cap .....	10330	16
1996-1995: Regular Locking Fuel Cap .....	10591		1997-1995: OE Type Radiator Cap .....	10230	16
1996-1995: Pre-Vent Locking Fuel Cap .....	10501		1997-1995: OE Equivalent Fuel Cap .....	10817	
1996-1995: Oil Filler Cap .....	10111		1997-1995: Pre-Vent Non-Locking Fuel Cap .....	10819	
<b>4-Cyl. 2.4 L</b>			1997-1995: Regular Locking Fuel Cap .....	10591	
2005-2003: Lev-R-Vent Radiator Cap .....	10334	18	1997-1995: Pre-Vent Locking Fuel Cap .....	10501	
2005-2003: OE Type Radiator Cap .....	10234	18	1997-1995: Diesel Pre-Vent Non-Locking Fuel Cap .....	10819D	
2005-2003: OE Equivalent Fuel Cap .....	10838		1997-1995: Diesel Regular Non-Locking Fuel Cap .....	10830D	
2005-2003: Regular Locking Fuel Cap .....	10508		1997-1995: Diesel Only Pre-Vent Locking Fuel Cap .....	10501D	
2005-2003: Oil Filler Cap .....	10111		1997-1995: Diesel Regular Locking Fuel Cap .....	10591D	
<b>Nitro</b>			1997-1995: Oil Filler Cap .....	10136	
<b>V-6 3.7 L</b>			<b>6-Cyl. 6.7 L Diesel</b>		
2011: OE Equivalent Fuel Cap .....	10838		2012: OE Equivalent Fuel Cap .....	10838	
2011: Regular Locking Fuel Cap .....	10508		2012: Diesel Regular Non-Locking Fuel Cap .....	10838D	
2010-2007: Lev-R-Vent Radiator Cap .....	10334	18	2012: Regular Locking Fuel Cap .....	10508	
2010-2007: OE Type Radiator Cap .....	10234	18	2012: Diesel Regular Locking Fuel Cap .....	10508D	
2010-2007: OE Equivalent Fuel Cap .....	10838		2011: OE Type Radiator Cap .....	10234	18
2010-2007: Regular Locking Fuel Cap .....	10508		2011: Lev-R-Vent Radiator Cap .....	10334	18
2010-2007: Oil Filler Cap .....	10120		2011: OE Equivalent Fuel Cap .....	10838	
<b>V-6 4.0 L</b>			2011: Diesel Regular Non-Locking Fuel Cap .....	10838D	
2011: OE Equivalent Fuel Cap .....	10838		2011: Regular Locking Fuel Cap .....	10508	
2011: Regular Locking Fuel Cap .....	10508		2011: Diesel Regular Locking Fuel Cap .....	10508D	
2010: Lev-R-Vent Radiator Cap .....	10334	18	2011: Oil Filler Cap .....	10111	
2010: OE Type Radiator Cap .....	10234	18	2010-2007: Lev-R-Vent Radiator Cap .....	10330	16
2010: OE Equivalent Fuel Cap .....	10838		2010-2007: OE Type Radiator Cap .....	10230	16
2010: Regular Locking Fuel Cap .....	10508		2010-2007: OE Equivalent Fuel Cap .....	10838	
2009-2007: Lev-R-Vent Radiator Cap .....	10334	18	2010-2007: Diesel Regular Non-Locking Fuel Cap .....	10838D	
2009-2007: OE Type Radiator Cap .....	10234	18	2010-2007: Regular Locking Fuel Cap .....	10508	
2009-2007: OE Equivalent Fuel Cap .....	10838		2010-2007: Diesel Regular Locking Fuel Cap .....	10508D	
2009-2007: Regular Locking Fuel Cap .....	10508		2010-2007: Oil Filler Cap .....	10111	
2009-2007: Oil Filler Cap .....	10148		<b>V-10 8.3 L</b>		
<b>Ram C/V</b>			2006-2004: Lev-R-Vent Radiator Cap .....	10330	16
<b>V-6 3.6 L</b>			2006-2004: OE Type Radiator Cap .....	10230	16
2012: OE Equivalent Fuel Cap .....	10838		2006-2004: OE Equivalent Fuel Cap .....	10838	
2012: Flex Fuel Regular Fuel Cap .....	10838Y		2006-2004: Regular Locking Fuel Cap .....	10508	
2012: Regular Locking Fuel Cap .....	10508		2006-2004: Oil Filler Cap .....	10111	
2012: Flex Fuel Regular Locking Fuel Cap .....	10508Y		<b>V-6 3.7 L</b>		
<b>Ram Series Pickup</b>			2012: OE Equivalent Fuel Cap .....	10838	
<b>6-Cyl. 5.9 L Diesel</b>			2012: Regular Locking Fuel Cap .....	10508	
2009-2000: Lev-R-Vent Radiator Cap .....	10330	16	2011-2009: Lev-R-Vent Radiator Cap .....	10330	16
2009-2000: OE Type Radiator Cap .....	10230	16	2011-2009: OE Type Radiator Cap .....	10230	16
			2011-2009: OE Equivalent Fuel Cap .....	10838	
			2011-2009: Regular Locking Fuel Cap .....	10508	
			2011-2009: Oil Filler Cap .....	10120	

## Caps for Passenger Cars and Light Trucks (1990 and Newer)

Application	Part Number	PSI	Application	Part Number	PSI
<b>Dodge - Continued</b>			<b>Dodge - Continued</b>		
<b>Ram Series Pickup - Continued</b>			<b>Ram Series Pickup - Continued</b>		
<b>V-6 3.7 L - Continued</b>			<b>V-8 4.7 L - Continued</b>		
2008-2007; Lev-R-Vent Radiator Cap .....	10330	16	2006-2002; OE Equivalent Fuel Cap .....	10838	
2008-2007; OE Type Radiator Cap .....	10230	16	2006-2002; Regular Locking Fuel Cap .....	10508	
2008-2007; OE Equivalent Fuel Cap .....	10838		2006-2002; Oil Filler Cap .....	10120	
2008-2007; Regular Locking Fuel Cap .....	10508		<b>V-8 5.2 L</b>		
2006-2003; Lev-R-Vent Radiator Cap .....	10330	16	2001; Lev-R-Vent Radiator Cap .....	10330	16
2006-2003; OE Type Radiator Cap .....	10230	16	2001; OE Type Radiator Cap .....	10230	16
2006-2003; OE Equivalent Fuel Cap .....	10838		2001; OE Equivalent Fuel Cap .....	10838	
2006-2003; Regular Locking Fuel Cap .....	10508		2001; Regular Locking Fuel Cap .....	10508	
2006-2003; Oil Filler Cap .....	10120		2001; Oil Filler Cap .....	10111	
2002; Lev-R-Vent Radiator Cap .....	10330	16	2000; Lev-R-Vent Radiator Cap .....	10331	16
2002; OE Type Radiator Cap .....	10230	16	2000; OE Type Radiator Cap .....	10231	16
2002; OE Equivalent Fuel Cap .....	10838		2000; OE Equivalent Fuel Cap .....	10838	
2002; Regular Locking Fuel Cap .....	10508		2000; Regular Locking Fuel Cap .....	10508	
2002; Oil Filler Cap .....	10111		2000; Oil Filler Cap .....	10111	
<b>V-6 3.9 L</b>			1999; Lev-R-Vent Radiator Cap .....	10330	16
2001; Lev-R-Vent Radiator Cap .....	10330	16	1999; OE Type Radiator Cap .....	10230	16
2001; OE Type Radiator Cap .....	10230	16	1999; OE Equivalent Fuel Cap .....	10817	
2001; OE Equivalent Fuel Cap .....	10838		1999; Pre-Vent Non-Locking Fuel Cap .....	10819	
2001; Regular Locking Fuel Cap .....	10508		1999; Regular Locking Fuel Cap .....	10591	
2001; Oil Filler Cap .....	10111		1999; Pre-Vent Locking Fuel Cap .....	10501	
2000; Lev-R-Vent Radiator Cap .....	10331	16	1999; Oil Filler Cap .....	10111	
2000; OE Type Radiator Cap .....	10231	16	1998; Lev-R-Vent Radiator Cap .....	10331	16
2000; OE Equivalent Fuel Cap .....	10838		1998; OE Type Radiator Cap .....	10231	16
2000; Regular Locking Fuel Cap .....	10508		1998; OE Equivalent Fuel Cap .....	10817	
2000; Oil Filler Cap .....	10111		1998; Pre-Vent Non-Locking Fuel Cap .....	10819	
1999; Lev-R-Vent Radiator Cap .....	10330	16	1998; Regular Locking Fuel Cap .....	10591	
1999; OE Type Radiator Cap .....	10230	16	1998; Pre-Vent Locking Fuel Cap .....	10501	
1999; OE Equivalent Fuel Cap .....	10817		1998; Oil Filler Cap .....	10111	
1999; Pre-Vent Non-Locking Fuel Cap .....	10819		1997-1995; Lev-R-Vent Radiator Cap .....	10331	16
1999; Regular Locking Fuel Cap .....	10591		1997-1995; OE Type Radiator Cap .....	10231	16
1999; Pre-Vent Locking Fuel Cap .....	10501		1997-1995; OE Equivalent Fuel Cap .....	10817	
1999; Oil Filler Cap .....	10111		1997-1995; Pre-Vent Non-Locking Fuel Cap .....	10819	
1998; Lev-R-Vent Radiator Cap .....	10331	16	1997-1995; Regular Locking Fuel Cap .....	10591	
1998; OE Type Radiator Cap .....	10231	16	1997-1995; Pre-Vent Locking Fuel Cap .....	10501	
1998; OE Equivalent Fuel Cap .....	10817		1997-1995; Oil Filler Cap .....	10111	
1998; Pre-Vent Non-Locking Fuel Cap .....	10819		1997-1995; Oil Breather Cap .....	10075	
1998; Regular Locking Fuel Cap .....	10591		<b>V-8 5.7 L</b>		
1998; Pre-Vent Locking Fuel Cap .....	10501		2012; OE Equivalent Fuel Cap .....	10838	
1998; Oil Filler Cap .....	10111		2012; Regular Locking Fuel Cap .....	10508	
1997-1995; Lev-R-Vent Radiator Cap .....	10331	16	2011-2009; Lev-R-Vent Radiator Cap .....	10330	16
1997-1995; OE Type Radiator Cap .....	10231	16	2011-2009; OE Type Radiator Cap .....	10230	16
1997-1995; OE Equivalent Fuel Cap .....	10817		2011-2009; OE Equivalent Fuel Cap .....	10838	
1997-1995; Pre-Vent Non-Locking Fuel Cap .....	10819		2011-2009; Regular Locking Fuel Cap .....	10508	
1997-1995; Regular Locking Fuel Cap .....	10591		2011-2009; Oil Filler Cap .....	10111	
1997-1995; Pre-Vent Locking Fuel Cap .....	10501		2008-2003; Lev-R-Vent Radiator Cap .....	10330	16
1997-1995; Oil Filler Cap .....	10111		2008-2003; OE Type Radiator Cap .....	10230	16
1997-1995; Oil Breather Cap .....	10075		2008-2003; OE Equivalent Fuel Cap .....	10838	
<b>V-8 4.7 L</b>			2008-2003; Regular Locking Fuel Cap .....	10508	
2012; OE Equivalent Fuel Cap .....	10838		2008-2003; Oil Filler Cap .....	10145	
2012; Flex Fuel Regular Fuel Cap .....	10838Y		<b>V-8 5.9 L; V-10 8.0 L</b>		
2012; Regular Locking Fuel Cap .....	10508		2003-2000; Lev-R-Vent Radiator Cap .....	10330	16
2012; Flex Fuel Regular Locking Fuel Cap .....	10508Y		2003-2000; OE Type Radiator Cap .....	10230	16
2011-2009; Lev-R-Vent Radiator Cap .....	10330	16	2003-2000; OE Equivalent Fuel Cap .....	10838	
2011-2009; OE Type Radiator Cap .....	10230	16	2003-2000; Regular Locking Fuel Cap .....	10508	
2011-2009; OE Equivalent Fuel Cap .....	10838		2003-2000; Oil Filler Cap .....	10111	
2011-2009; Flex Fuel Regular Fuel Cap .....	10838Y		1999; Lev-R-Vent Radiator Cap .....	10330	16
2011-2009; Regular Locking Fuel Cap .....	10508		1999; OE Type Radiator Cap .....	10230	16
2011-2009; Flex Fuel Regular Locking Fuel Cap .....	10508Y		1999; OE Equivalent Fuel Cap .....	10817	
2011-2009; Oil Filler Cap .....	10120		1999; Pre-Vent Non-Locking Fuel Cap .....	10819	
2008; Lev-R-Vent Radiator Cap .....	10330	16	1999; Regular Locking Fuel Cap .....	10591	
2008; OE Type Radiator Cap .....	10230	16	1999; Pre-Vent Locking Fuel Cap .....	10501	
2008; OE Equivalent Fuel Cap .....	10838		1999; Oil Filler Cap .....	10111	
2008; Regular Locking Fuel Cap .....	10508		1998; Lev-R-Vent Radiator Cap .....	10331	16
2007; Lev-R-Vent Radiator Cap .....	10330	16	1998; OE Type Radiator Cap .....	10231	16
2007; OE Type Radiator Cap .....	10230	16	1998; OE Equivalent Fuel Cap .....	10817	
2007; OE Equivalent Fuel Cap .....	10838		1998; Pre-Vent Non-Locking Fuel Cap .....	10819	
2007; Flex Fuel Regular Fuel Cap .....	10838Y		1998; Regular Locking Fuel Cap .....	10591	
2007; Regular Locking Fuel Cap .....	10508		1998; Pre-Vent Locking Fuel Cap .....	10501	
2007; Flex Fuel Regular Locking Fuel Cap .....	10508Y		1998; Oil Filler Cap .....	10111	
2007; Oil Filler Cap .....	10120		1998; Lev-R-Vent Radiator Cap .....	10331	16
2006-2002; Lev-R-Vent Radiator Cap .....	10330	16	1997-1995; OE Type Radiator Cap .....	10231	16
2006-2002; OE Type Radiator Cap .....	10230	16	1997-1995; OE Equivalent Fuel Cap .....	10817	

## Caps for Passenger Cars and Light Trucks (1990 and Newer)

Application	Part Number	PSI	Application	Part Number	PSI
<b>Dodge - Continued</b>			<b>Dodge - Continued</b>		
<b>Ram Series Pickup - Continued</b>			<b>Stratus - Continued</b>		
<b>V-8 5.9 L; V-10 8.0 L - Continued</b>			<b>4-Cyl. 2.0 L - Continued</b>		
1997-1995; Pre-Vent Non-Locking Fuel Cap .....	10819		1995; Lev-R-Vent Radiator Cap .....	10331	16
1997-1995; Regular Locking Fuel Cap .....	10591		1995; OE Type Radiator Cap .....	10231	16
1997-1995; Pre-Vent Locking Fuel Cap .....	10501		1995; OE Equivalent Fuel Cap .....	10817	
1997-1995; Oil Filler Cap .....	10111		1995; Pre-Vent Non-Locking Fuel Cap .....	10819	
1997-1995; Oil Breather Cap .....	10075		1995; Regular Locking Fuel Cap .....	10591	
<b>Spirit</b>			1995; Pre-Vent Locking Fuel Cap .....	10501	
<b>4-Cyl. 2.5 L</b>			1995; Oil Filler Cap .....	10111	
1995; Lev-R-Vent Radiator Cap .....	10331	16	<b>4-Cyl. 2.4 L</b>		
1995; OE Type Radiator Cap .....	10231	16	2006; Lev-R-Vent Radiator Cap; Eng. VIN X .....	10334	18
1995; OE Equivalent Fuel Cap .....	10817		2006; OE Type Radiator Cap; Eng. VIN X .....	10234	18
1995; Pre-Vent Non-Locking Fuel Cap .....	10819		2006; OE Equivalent Fuel Cap .....	10838	
1995; Regular Locking Fuel Cap .....	10591		2006; Regular Locking Fuel Cap .....	10508	
1995; Pre-Vent Locking Fuel Cap .....	10501		2006; Oil Filler Cap; Eng. VIN X .....	10111	
1995; Oil Filler Cap .....	10111		2005; OE Type Radiator Cap; W/SOHC Eng. ....	10242	16
<b>V-6 3.0 L</b>			2005; Lev-R-Vent Radiator Cap; W/DOHC Eng. ....	10334	18
1995; Lev-R-Vent Radiator Cap .....	10331	16	2005; OE Type Radiator Cap; W/DOHC Eng. ....	10234	18
1995; OE Type Radiator Cap .....	10231	16	2005; OE Equivalent Fuel Cap .....	10838	
1995; OE Equivalent Fuel Cap .....	10817		2005; Regular Locking Fuel Cap .....	10508	
1995; Pre-Vent Non-Locking Fuel Cap .....	10819		2005; Oil Filler Cap; W/SOHC Eng. ....	10088	
1995; Regular Locking Fuel Cap .....	10591		2005; Oil Filler Cap; W/DOHC Eng. ....	10111	
1995; Pre-Vent Locking Fuel Cap .....	10501		2004; OE Type Radiator Cap; W/SOHC Eng. ....	10242	16
1995; Oil Filler Cap .....	10088		2004; Lev-R-Vent Radiator Cap; W/DOHC Eng. ....	10334	18
<b>Sprinter</b>			2004; OE Type Radiator Cap; W/DOHC Eng. ....	10234	18
<b>5-Cyl. 2.7 L Diesel</b>			2004; OE Equivalent Fuel Cap .....	10838	
2006; OE Type Radiator Cap .....	10252	15	2004; Regular Locking Fuel Cap .....	10508	
2006; OE Equivalent Fuel Cap .....	10843		2004; Oil Filler Cap; Eng. VIN G .....	10088	
2005-2003; Lev-R-Vent Radiator Cap .....	10334	18	2004; Oil Filler Cap; Eng. VIN X .....	10111	
2005-2003; OE Type Radiator Cap .....	10234	18	2003; OE Type Radiator Cap; W/SOHC Eng. ....	10242	16
2005-2003; OE Equivalent Fuel Cap .....	10843		2003; Lev-R-Vent Radiator Cap; W/DOHC Eng. ....	10331	16
<b>V-6 3.0 L Diesel</b>			2003; OE Type Radiator Cap; W/DOHC Eng. ....	10231	16
2010; OE Type Radiator Cap .....	10252	15	2003; OE Equivalent Fuel Cap .....	10838	
2009-2008; OE Type Radiator Cap .....	10252	15	2003; Regular Locking Fuel Cap .....	10508	
2009-2008; Oil Filler Cap .....	10130		2003; Oil Filler Cap; W/SOHC Eng. ....	10088	
2007; OE Type Radiator Cap .....	10252	15	2003; Oil Filler Cap; W/DOHC Eng. ....	10111	
<b>V-6 3.5 L</b>			2002; Lev-R-Vent Radiator Cap; W/DOHC Eng. ....	10331	16
2008; OE Type Radiator Cap .....	10252	15	2002; OE Type Radiator Cap; W/DOHC Eng. ....	10231	16
2008; Oil Filler Cap .....	10130		2002; OE Equivalent Fuel Cap .....	10838	
2007; OE Type Radiator Cap .....	10252	15	2002; Regular Locking Fuel Cap .....	10508	
<b>Stealth</b>			2002; Oil Filler Cap; W/SOHC Eng. ....	10088	
<b>V-6 3.0 L</b>			2002; Oil Filler Cap; W/DOHC Eng. ....	10111	
1996-1995; Lev-R-Vent Radiator Cap .....	✓10327	13	2001; OE Type Radiator Cap; W/SOHC Eng. ....	10241	13
1996-1995; OE Type Radiator Cap .....	10227	13	2001; Lev-R-Vent Radiator Cap; W/DOHC Eng. ....	10331	16
1996-1995; OE Equivalent Fuel Cap .....	10817		2001; OE Type Radiator Cap; W/DOHC Eng. ....	10231	16
1996-1995; Pre-Vent Non-Locking Fuel Cap .....	10819		2001; OE Equivalent Fuel Cap .....	10838	
1996-1995; Regular Locking Fuel Cap .....	10591		2001; Regular Locking Fuel Cap .....	10508	
1996-1995; Pre-Vent Locking Fuel Cap .....	10501		2001; Oil Filler Cap; W/SOHC Eng. ....	10088	
1996-1995; Oil Filler Cap .....	10088		2001; Oil Filler Cap; W/DOHC Eng. ....	10111	
<b>Stratus</b>			2000-1999; Lev-R-Vent Radiator Cap .....	10331	16
<b>4-Cyl. 2.0 L</b>			2000-1999; OE Type Radiator Cap .....	10231	16
2000; Lev-R-Vent Radiator Cap .....	10331	16	2000-1999; OE Equivalent Fuel Cap .....	10838	
2000; OE Type Radiator Cap .....	10231	16	2000-1999; Regular Locking Fuel Cap .....	10508	
2000; OE Equivalent Fuel Cap .....	10838		2000-1999; Oil Filler Cap .....	10111	
2000; Regular Locking Fuel Cap .....	10508		1998-1995; Lev-R-Vent Radiator Cap .....	10331	16
2000; Oil Filler Cap .....	10111		1998-1995; OE Type Radiator Cap .....	10231	16
1999-1997; Lev-R-Vent Radiator Cap .....	10331	16	1998-1995; OE Equivalent Fuel Cap .....	10817	
1999-1997; OE Type Radiator Cap .....	10231	16	1998-1995; Pre-Vent Non-Locking Fuel Cap .....	10819	
1999-1997; OE Equivalent Fuel Cap .....	10817		1998-1995; Regular Locking Fuel Cap .....	10591	
1999-1997; Pre-Vent Non-Locking Fuel Cap .....	10819		1998-1995; Pre-Vent Locking Fuel Cap .....	10501	
1999-1997; Regular Locking Fuel Cap .....	10591		1998-1995; Oil Filler Cap .....	10111	
1999-1997; Pre-Vent Locking Fuel Cap .....	10501		<b>V-6 2.5 L</b>		
1999-1997; Oil Filler Cap .....	10111		2000; Lev-R-Vent Radiator Cap .....	10331	16
1996; Lev-R-Vent Radiator Cap .....	10331	16	2000; OE Type Radiator Cap .....	10231	16
1996; OE Type Radiator Cap .....	10231	16	2000; OE Equivalent Fuel Cap .....	10838	
1996; OE Equivalent Fuel Cap .....	10817		2000; Regular Locking Fuel Cap .....	10508	
1996; Pre-Vent Non-Locking Fuel Cap .....	10819		2000; Oil Filler Cap .....	10111	
1996; Regular Locking Fuel Cap .....	10591		1999; Lev-R-Vent Radiator Cap .....	10331	16
1996; Pre-Vent Locking Fuel Cap .....	10501		1999; OE Type Radiator Cap .....	10231	16
1996; Oil Filler Cap .....	10088		1999; OE Equivalent Fuel Cap .....	10838	
			1999; Regular Locking Fuel Cap .....	10508	
			1999; Oil Filler Cap .....	10088	
			1998-1995; Lev-R-Vent Radiator Cap .....	10331	16
			1998-1995; OE Type Radiator Cap .....	10231	16

✓ Check Hood Clearance prior to installing this Cap.

## Caps for Passenger Cars and Light Trucks (1990 and Newer)

Application	Part Number	PSI	Application	Part Number	PSI
<b>Dodge - Continued</b>			<b>Eagle</b>		
<b>Stratus - Continued</b>			<b>Summit</b>		
<b>V-6 2.5 L - Continued</b>			<b>4-Cyl. 1.5 L; 4-Cyl. 1.8 L; 4-Cyl. 2.4 L</b>		
1998-1995: OE Equivalent Fuel Cap .....	10817		1996-1995: OE Type Radiator Cap .....	10241	13
1998-1995: Pre-Vent Non-Locking Fuel Cap .....	10819		1996-1995: OE Equivalent Fuel Cap .....	10825	
1998-1995: Regular Locking Fuel Cap .....	10591		1996-1995: Regular Locking Fuel Cap .....	10595	
1998-1995: Pre-Vent Locking Fuel Cap .....	10501		1996-1995: Oil Filler Cap .....	10088	
1998-1995: Oil Filler Cap .....	10088		<b>Talon</b>		
<b>V-6 2.7 L</b>			<b>4-Cyl. 2.0 L</b>		
2006-2004: Lev-R-Vent Radiator Cap .....	10330	16	1998: Lev-R-Vent Radiator Cap: Eng. VIN F .....	✓10327	13
2006-2004: OE Type Radiator Cap .....	10230	16	1998: OE Type Radiator Cap: Eng. VIN F .....	10227	13
2006-2004: OE Equivalent Fuel Cap .....	10838		1998: Lev-R-Vent Radiator Cap: Eng. VIN Y .....	✓10333	16
2006-2004: Flex Fuel Regular Fuel Cap .....	10838Y		1998: OE Type Radiator Cap: Eng. VIN Y .....	10233	16
2006-2004: Regular Locking Fuel Cap .....	10508		1998: OE Equivalent Fuel Cap .....	10817	
2006-2004: Flex Fuel Regular Locking Fuel Cap .....	10508Y		1998: Pre-Vent Non-Locking Fuel Cap .....	10819	
2006-2004: Oil Filler Cap .....	10099		1998: Regular Locking Fuel Cap .....	10591	
2003-2001: Lev-R-Vent Radiator Cap .....	10330	16	1998: Pre-Vent Locking Fuel Cap .....	10501	
2003-2001: OE Type Radiator Cap .....	10230	16	1998: Oil Filler Cap: Eng. VIN F .....	10088	
2003-2001: OE Equivalent Fuel Cap .....	10838		1998: Oil Filler Cap: Eng. VIN Y .....	10111	
2003-2001: Regular Locking Fuel Cap .....	10508		1997: Lev-R-Vent Radiator Cap: Eng. VIN F .....	✓10327	13
2003-2001: Oil Filler Cap .....	10099		1997: OE Type Radiator Cap: Eng. VIN F .....	10227	13
<b>V-6 3.0 L</b>			1997: Lev-R-Vent Radiator Cap: Eng. VIN Y .....	✓10333	16
2005-2001: OE Type Radiator Cap .....	10242	16	1997: OE Type Radiator Cap: Eng. VIN Y .....	10233	16
2005-2001: OE Equivalent Fuel Cap .....	10838		1997: OE Equivalent Fuel Cap .....	10817	
2005-2001: Regular Locking Fuel Cap .....	10508		1997: Pre-Vent Non-Locking Fuel Cap .....	10819	
2005-2001: Oil Filler Cap .....	10088		1997: Regular Locking Fuel Cap .....	10591	
<b>SX</b>			1997: Pre-Vent Locking Fuel Cap .....	10501	
<b>4-Cyl. 2.0 L (Canada)</b>			1997: Oil Filler Cap .....	10088	
2005: Lev-R-Vent Radiator Cap .....	10334	18	1996: Lev-R-Vent Radiator Cap: Eng. VIN F .....	✓10327	13
2005: OE Type Radiator Cap .....	10234	18	1996: OE Type Radiator Cap: Eng. VIN F .....	10227	13
2005: OE Equivalent Fuel Cap .....	10838		1996: Lev-R-Vent Radiator Cap: Eng. VIN Y .....	✓10333	16
2005: Regular Locking Fuel Cap .....	10508		1996: OE Type Radiator Cap: Eng. VIN Y .....	10233	16
2005: Oil Filler Cap .....	10111		1996: OE Equivalent Fuel Cap .....	10817	
2004-2003: Lev-R-Vent Radiator Cap .....	10330	16	1996: Pre-Vent Non-Locking Fuel Cap .....	10819	
2004-2003: OE Type Radiator Cap .....	10230	16	1996: Regular Locking Fuel Cap .....	10591	
2004-2003: OE Equivalent Fuel Cap .....	10838		1996: Pre-Vent Locking Fuel Cap .....	10501	
2004-2003: Regular Locking Fuel Cap .....	10508		1996: Oil Filler Cap: Eng. VIN F .....	10088	
2004-2003: Oil Filler Cap .....	10111		1996: Oil Filler Cap: Eng. VIN Y .....	10111	
<b>4-Cyl. 2.4 L (Canada)</b>			1995: Lev-R-Vent Radiator Cap: Eng. VIN F .....	✓10327	13
2005: Lev-R-Vent Radiator Cap .....	10334	18	1995: OE Type Radiator Cap: Eng. VIN F .....	10227	13
2005: OE Type Radiator Cap .....	10234	18	1995: Lev-R-Vent Radiator Cap: Eng. VIN Y .....	✓10333	16
2005: OE Equivalent Fuel Cap .....	10838		1995: OE Type Radiator Cap: Eng. VIN Y .....	10233	16
2005: Regular Locking Fuel Cap .....	10508		1995: OE Equivalent Fuel Cap .....	10817	
2005: Oil Filler Cap .....	10111		1995: Pre-Vent Non-Locking Fuel Cap .....	10819	
<b>Viper</b>			1995: Regular Locking Fuel Cap .....	10591	
<b>V-10 8.0 L</b>			1995: Pre-Vent Locking Fuel Cap .....	10501	
2002-1997: Lev-R-Vent Radiator Cap .....	10330	16	1995: Oil Filler Cap .....	10088	
2002-1997: OE Type Radiator Cap .....	10230	16	<b>Vision</b>		
2002-1997: OE Equivalent Fuel Cap .....	10817		<b>V-6 3.3 L</b>		
2002-1997: Pre-Vent Non-Locking Fuel Cap .....	10819		1996-1995: Lev-R-Vent Radiator Cap .....	10330	16
2002-1997: Regular Locking Fuel Cap .....	10591		1996-1995: OE Type Radiator Cap .....	10230	16
2002-1997: Pre-Vent Locking Fuel Cap .....	10501		1996-1995: OE Equivalent Fuel Cap .....	10817	
2002-1997: Oil Filler Cap .....	10111		1996-1995: Pre-Vent Non-Locking Fuel Cap .....	10819	
1996-1995: Lev-R-Vent Radiator Cap .....	10331	16	1996-1995: Regular Locking Fuel Cap .....	10591	
1996-1995: OE Type Radiator Cap .....	10231	16	1996-1995: Pre-Vent Locking Fuel Cap .....	10501	
1996-1995: OE Equivalent Fuel Cap .....	10817		1996-1995: Oil Filler Cap .....	10066	
1996-1995: Pre-Vent Non-Locking Fuel Cap .....	10819		<b>V-6 3.3 L (Canada)</b>		
1996-1995: Regular Locking Fuel Cap .....	10591		1997: Lev-R-Vent Radiator Cap .....	10330	16
1996-1995: Pre-Vent Locking Fuel Cap .....	10501		1997: OE Type Radiator Cap .....	10230	16
1996-1995: Oil Filler Cap .....	10111		1997: OE Equivalent Fuel Cap .....	10817	
<b>V-10 8.3 L</b>			1997: Pre-Vent Non-Locking Fuel Cap .....	10819	
2006-2003: Lev-R-Vent Radiator Cap .....	10330	16	1997: Regular Locking Fuel Cap .....	10591	
2006-2003: OE Type Radiator Cap .....	10230	16	1997: Pre-Vent Locking Fuel Cap .....	10501	
2006-2003: OE Equivalent Fuel Cap .....	10838		1997: Oil Filler Cap .....	10066	
2006-2003: Regular Locking Fuel Cap .....	10508		<b>V-6 3.5 L</b>		
2006-2003: Oil Filler Cap .....	10111		1997-1995: Lev-R-Vent Radiator Cap .....	10330	16
<b>V-10 8.4 L</b>			1997-1995: OE Type Radiator Cap .....	10230	16
2009-2008: Lev-R-Vent Radiator Cap .....	10335	20	1997-1995: OE Equivalent Fuel Cap .....	10817	
2009-2008: OE Type Radiator Cap .....	10235	20	1997-1995: Pre-Vent Non-Locking Fuel Cap .....	10819	
2009-2008: OE Equivalent Fuel Cap .....	10838		1997-1995: Regular Locking Fuel Cap .....	10591	
2009-2008: Regular Locking Fuel Cap .....	10508		1997-1995: Pre-Vent Locking Fuel Cap .....	10501	
2009-2008: Oil Filler Cap .....	10111		1997-1995: Oil Filler Cap .....	10111	

✓ Check Hood Clearance prior to installing this Cap.

## Caps for Passenger Cars and Light Trucks (1990 and Newer)

Application	Part Number	PSI	Application	Part Number	PSI
<b>Ford</b>			<b>Ford - Continued</b>		
<b>Aerostar</b>			<b>E Series Van - Continued</b>		
<b>V-6 3.0 L; V-6 4.0 L</b>			<b>6-Cyl. 4.9 L - Continued</b>		
1997-1995; Lev-R-Vent Radiator Cap .....	10330	16	1996-1995; Pre-Vent Non-Locking Fuel Cap .....	10819	
1997-1995; OE Type Radiator Cap .....	10230	16	1996-1995; Pre-Vent Locking Fuel Cap .....	10501	
1997-1995; Pre-Vent Non-Locking Fuel Cap .....	10819		1996-1995; Oil Filler Cap .....	10081	
1997-1995; Pre-Vent Locking Fuel Cap .....	10501				
1997-1995; Oil Filler Cap .....	10081		<b>V-10 6.8 L</b>		
<b>Aspire</b>			2011; OE Type Radiator Cap .....	10238	16
<b>4-Cyl. 1.3 L</b>			2011; OE Equivalent Fuel Cap .....	10840	
1997-1995; Lev-R-Vent Radiator Cap .....	✓10327	13	2011; Regular Locking Fuel Cap .....	10510	
1997-1995; OE Type Radiator Cap .....	10227	13	2011; Oil Filler Cap .....	10117	
1997-1995; OE Equivalent Fuel Cap .....	10817		1998; OE Type Radiator Cap .....	10238	16
1997-1995; Pre-Vent Non-Locking Fuel Cap .....	10819		1998; OE Equivalent Fuel Cap .....	10832	
1997-1995; Regular Locking Fuel Cap .....	10591		1998; Regular Locking Fuel Cap .....	10502	
1997-1995; Pre-Vent Locking Fuel Cap .....	10501		1998; Oil Filler Cap .....	10081	
1997-1995; Oil Filler Cap .....	10082		1997; Lev-R-Vent Radiator Cap .....	10329	13
<b>Bronco</b>			1997; OE Type Radiator Cap .....	10229	13
<b>V-8 5.0 L; V-8 5.8 L</b>			1997; OE Equivalent Fuel Cap .....	10832	
1996-1995; Lev-R-Vent Radiator Cap .....	10329	13	1997; Regular Locking Fuel Cap .....	10502	
1996-1995; OE Type Radiator Cap .....	10229	13	1997; Oil Filler Cap .....	10081	
1996-1995; Pre-Vent Non-Locking Fuel Cap .....	10819		<b>V-6 4.2 L</b>		
1996-1995; Pre-Vent Locking Fuel Cap .....	10501		2003-1998; OE Type Radiator Cap .....	10238	16
1996-1995; Oil Filler Cap .....	10081		2003-1998; OE Equivalent Fuel Cap .....	10832	
<b>Contour</b>			2003-1998; Regular Locking Fuel Cap .....	10502	
<b>4-Cyl. 2.0 L</b>			2003-1998; Oil Filler Cap .....	10081	
2000-1998; OE Type Radiator Cap .....	10251	17	1997; Lev-R-Vent Radiator Cap .....	10329	13
2000-1998; OE Equivalent Fuel Cap .....	10837		1997; OE Type Radiator Cap .....	10229	13
2000-1998; Regular Locking Fuel Cap .....	10507		1997; OE Equivalent Fuel Cap .....	10832	
2000-1998; Oil Filler Cap .....	10101		1997; Regular Locking Fuel Cap .....	10502	
1997-1995; OE Type Radiator Cap .....	10250	18	1997; Oil Filler Cap .....	10081	
1997-1995; Pre-Vent Non-Locking Fuel Cap .....	10819		<b>V-8 4.6 L</b>		
1997-1995; Pre-Vent Locking Fuel Cap .....	10501		2012; OE Equivalent Fuel Cap .....	10840	
1997-1995; Oil Filler Cap .....	10101		2012; Flex Fuel Regular Fuel Cap .....	10840Y	
<b>V-6 2.5 L</b>			2012; Regular Locking Fuel Cap .....	10510	
2000-1998; OE Type Radiator Cap .....	10251	17	2012; Flex Fuel Regular Locking Fuel Cap .....	10510Y	
2000-1998; OE Equivalent Fuel Cap .....	10837		2011; OE Type Radiator Cap .....	10238	16
2000-1998; Regular Locking Fuel Cap .....	10507		2011; OE Equivalent Fuel Cap .....	10840	
2000-1998; Oil Filler Cap .....	10081		2011; Flex Fuel Regular Fuel Cap .....	10840Y	
1997-1995; OE Type Radiator Cap .....	10250	18	2011; Regular Locking Fuel Cap .....	10510	
1997-1995; Pre-Vent Non-Locking Fuel Cap .....	10819		2011; Flex Fuel Regular Locking Fuel Cap .....	10510Y	
1997-1995; Pre-Vent Locking Fuel Cap .....	10501		2011; Oil Filler Cap .....	10117	
1997-1995; Oil Filler Cap .....	10081		2010-2009; OE Type Radiator Cap .....	10238	16
<b>Crown Victoria</b>			2010-2009; OE Equivalent Fuel Cap .....	10840	
<b>V-8 4.6 L</b>			2010-2009; Regular Locking Fuel Cap .....	10510	
2011-2006; OE Type Radiator Cap .....	10238	16	2010-2009; Flex Fuel Regular Fuel Cap .....	10840Y	
2011-2006; OE Equivalent Fuel Cap .....	10840		2010-2009; Flex Fuel Regular Locking Fuel Cap .....	10510Y	
2011-2006; Flex Fuel Regular Fuel Cap .....	10840Y		2010-2009; Oil Filler Cap .....	10117	
2011-2006; Regular Locking Fuel Cap .....	10510		2008; OE Type Radiator Cap .....	10238	16
2011-2006; Flex Fuel Regular Locking Fuel Cap .....	10510Y		2008; OE Equivalent Fuel Cap .....	10840	
2011-2006; Oil Filler Cap .....	10117		2008; Regular Locking Fuel Cap .....	10510	
2005; OE Type Radiator Cap .....	10238	16	2008; Oil Filler Cap .....	10117	
2005; OE Equivalent Fuel Cap .....	10840		2007; OE Type Radiator Cap .....	10238	16
2005; Regular Locking Fuel Cap .....	10510		2007; OE Equivalent Fuel Cap .....	10840	
2005; Oil Filler Cap .....	10117		2007; Regular Locking Fuel Cap .....	10510	
2004-2003; OE Type Radiator Cap .....	10238	16	2007; Oil Filler Cap .....	10081	
2004-2003; OE Equivalent Fuel Cap .....	10832		2006; OE Type Radiator Cap .....	10238	16
2004-2003; Regular Locking Fuel Cap .....	10502		2006; OE Equivalent Fuel Cap .....	10840	
2004-2003; Oil Filler Cap .....	10117		2006; Regular Locking Fuel Cap .....	10510	
2002-1996; OE Type Radiator Cap .....	10238	16	2006; Oil Filler Cap .....	10117	
2002-1996; OE Equivalent Fuel Cap .....	10832		2005-2004; OE Type Radiator Cap .....	10238	16
2002-1996; Regular Locking Fuel Cap .....	10502		2005-2004; OE Equivalent Fuel Cap .....	10840	
2002-1996; Oil Filler Cap .....	10081		2005-2004; Regular Locking Fuel Cap .....	10510	
1995; OE Type Radiator Cap .....	10238	16	2005-2004; Oil Filler Cap .....	10081	
1995; Pre-Vent Non-Locking Fuel Cap .....	10819		2003-1998; OE Type Radiator Cap .....	10238	16
1995; Pre-Vent Locking Fuel Cap .....	10501		2003-1998; OE Equivalent Fuel Cap .....	10832	
1995; Oil Filler Cap .....	10081		2003-1998; Regular Locking Fuel Cap .....	10502	
<b>E Series Van</b>			2003-1998; Oil Filler Cap .....	10081	
<b>6-Cyl. 4.9 L</b>			1997; Lev-R-Vent Radiator Cap .....	10329	13
1996-1995; Lev-R-Vent Radiator Cap .....	10329	13	1997; OE Type Radiator Cap .....	10229	13
1996-1995; OE Type Radiator Cap .....	10229	13	1997; OE Equivalent Fuel Cap .....	10832	
			1997; Regular Locking Fuel Cap .....	10502	
			1997; Oil Filler Cap .....	10081	
			<b>V-8 5.0 L</b>		
			1996-1995; Lev-R-Vent Radiator Cap .....	10329	13
			1996-1995; OE Type Radiator Cap .....	10229	13

✓ Check Hood Clearance prior to installing this Cap.

## Caps for Passenger Cars and Light Trucks (1990 and Newer)

Application	Part Number	PSI	Application	Part Number	PSI
<b>Ford - Continued</b>			<b>Ford - Continued</b>		
<b>E Series Van - Continued</b>			<b>E Series Van - Continued</b>		
<b>V-8 5.0 L - Continued</b>			<b>V-8 7.3 L Diesel - Continued</b>		
1996-1995; Pre-Vent Non-Locking Fuel Cap .....	10819		1998-1997; OE Equivalent Fuel Cap; W/O Threaded Filler Neck .....	10832	
1996-1995; Pre-Vent Locking Fuel Cap .....	10501		1998-1997; Diesel Regular Non-Locking Fuel Cap; W/O Threaded Filler Neck .....	10832D	
1996-1995; Oil Filler Cap .....	10081		1998-1997; Regular Locking Fuel Cap; W/O Threaded Filler Neck .....	10502	
<b>V-8 5.4 L</b>			1998-1997; Diesel Regular Locking Fuel Cap; W/O Threaded Filler Neck .....		
2012; OE Equivalent Fuel Cap .....	10840		1998-1997; Oil Filler Cap .....	10081	
2012; Flex Fuel Regular Fuel Cap .....	10840Y		1996-1995; OE Type Radiator Cap .....	10238	16
2012; Regular Locking Fuel Cap .....	10510		1996-1995; OE Equivalent Fuel Cap .....	10817	
2012; Flex Fuel Regular Locking Fuel Cap .....	10510Y		1996-1995; Diesel Regular Non-Locking Fuel Cap .....	10830D	
2011; OE Type Radiator Cap .....	10238	16	1996-1995; Regular Locking Fuel Cap .....	10591	
2011; OE Equivalent Fuel Cap .....	10840		1996-1995; Diesel Regular Locking Fuel Cap .....	10591D	
2011; Regular Locking Fuel Cap .....	10510		1996-1995; Pre-Vent Non-Locking Fuel Cap .....	10819	
2011; Flex Fuel Regular Fuel Cap .....	10840Y		1996-1995; Diesel Pre-Vent Non-Locking Fuel Cap .....	10819D	
2011; Flex Fuel Regular Locking Fuel Cap .....	10510Y		1996-1995; Pre-Vent Locking Fuel Cap .....	10501	
2011; Oil Filler Cap .....	10117		1996-1995; Diesel Only Pre-Vent Locking Fuel Cap .....	10501D	
2010; OE Type Radiator Cap .....	10238	16	1996-1995; Oil Filler Cap .....	10081	
2010; OE Equivalent Fuel Cap .....	10840		<b>V-8 7.5 L</b>		
2010; Flex Fuel Regular Fuel Cap .....	10840Y		1996-1995; Lev-R-Vent Radiator Cap .....	10329	13
2010; Regular Locking Fuel Cap .....	10510		1996-1995; OE Type Radiator Cap .....	10229	13
2010; Flex Fuel Regular Locking Fuel Cap .....	10510Y		1996-1995; Pre-Vent Non-Locking Fuel Cap .....	10819	
2010; Oil Filler Cap .....	10117		1996-1995; Pre-Vent Locking Fuel Cap .....	10501	
2009; OE Type Radiator Cap .....	10238	16	1996-1995; Oil Filler Cap; W/O Oil Filler Tube .....	10100	
2009; OE Equivalent Fuel Cap .....	10840		1996-1995; Oil Breather Cap; W/O Oil Filler Tube .....	10071	
2009; Regular Locking Fuel Cap .....	10510		<b>Edge</b>		
2009; Flex Fuel Regular Fuel Cap .....	10840Y		<b>V-6 3.5 L</b>		
2009; Flex Fuel Regular Locking Fuel Cap .....	10510Y		2011; OE Type Radiator Cap .....	10238	16
2009; Oil Filler Cap .....	10117		2011; Oil Filler Cap .....	10117	
2008-2004; OE Type Radiator Cap .....	10238	16	2010-2007; OE Type Radiator Cap .....	10238	16
2008-2004; OE Equivalent Fuel Cap .....	10840		2010-2007; OE Equivalent Fuel Cap .....	10840	
2008-2004; Regular Locking Fuel Cap .....	10510		2010-2007; Regular Locking Fuel Cap .....	10510	
2008-2004; Oil Filler Cap .....	10117		2010-2007; Oil Filler Cap .....	10117	
2003-2002; OE Type Radiator Cap .....	10238	16	<b>V-6 3.7 L</b>		
2003-2002; OE Equivalent Fuel Cap; W/O Stripped Chassis .....	10832		2011; OE Type Radiator Cap .....	10238	16
2003-2002; Regular Locking Fuel Cap; W/O Stripped Chassis .....	10502		2011; Oil Filler Cap .....	10117	
2003-2002; Oil Filler Cap .....	10081		<b>Escape</b>		
2001-2000; OE Type Radiator Cap .....	10238	16	<b>4-Cyl. 2.0 L</b>		
2001-2000; OE Equivalent Fuel Cap; W/O Threaded Filler Neck .....	10832		2004; OE Type Radiator Cap .....	10251	17
2001-2000; Regular Locking Fuel Cap; W/O Threaded Filler Neck .....	10502		2004; OE Equivalent Fuel Cap .....	10832	
2001-2000; Regular Locking Fuel Cap; W/O Threaded Filler Neck .....	10503		2004; Regular Locking Fuel Cap .....	10502	
2001-2000; Oil Filler Cap .....	10081		2004; Oil Filler Cap .....	10144	
1999; OE Type Radiator Cap .....	10238	16	2003-2002; OE Type Radiator Cap .....	10251	17
1999; OE Equivalent Fuel Cap .....	10832		2003-2002; OE Equivalent Fuel Cap .....	10832	
1999; Flex Fuel Regular Fuel Cap .....	10832Y		2003-2002; Regular Locking Fuel Cap .....	10502	
1999; Regular Locking Fuel Cap .....	10502		2003-2002; Oil Filler Cap .....	10081	
1999; Flex Fuel Regular Locking Fuel Cap .....	10502Y		2001; OE Type Radiator Cap .....	10251	17
1999; Oil Filler Cap .....	10081		2001; OE Equivalent Fuel Cap .....	10832	
1998-1997; OE Type Radiator Cap .....	10238	16	2001; Regular Locking Fuel Cap .....	10502	
1998-1997; OE Equivalent Fuel Cap .....	10832		2001; Oil Filler Cap .....	10101	
1998-1997; Regular Locking Fuel Cap .....	10502		<b>4-Cyl. 2.3 L</b>		
1998-1997; Oil Filler Cap .....	10081		2008-2007; OE Type Radiator Cap .....	10251	17
<b>V-8 5.8 L</b>			2008-2007; OE Equivalent Fuel Cap .....	10840	
1996-1995; Lev-R-Vent Radiator Cap .....	10329	13	2008-2007; Regular Locking Fuel Cap .....	10510	
1996-1995; OE Type Radiator Cap .....	10229	13	2008-2007; Oil Filler Cap .....	10144	
1996-1995; Pre-Vent Non-Locking Fuel Cap .....	10819		2006; OE Type Radiator Cap .....	10251	17
1996-1995; Pre-Vent Locking Fuel Cap .....	10501		2006; OE Equivalent Fuel Cap .....	10840	
1996-1995; Oil Filler Cap .....	10081		2006; Regular Locking Fuel Cap .....	10510	
<b>V-8 7.3 L Diesel</b>			2006; Oil Filler Cap .....	10117	
1998-1997; OE Type Radiator Cap .....	10238	16	2005; OE Type Radiator Cap .....	10251	17
1998-1997; OE Equivalent Fuel Cap; W/Threaded Filler Neck .....	10817		2005; OE Equivalent Fuel Cap .....	10840	
1998-1997; Diesel Regular Non-Locking Fuel Cap; W/Threaded Filler Neck .....	10830D		2005; Regular Locking Fuel Cap .....	10510	
1998-1997; Regular Locking Fuel Cap; W/Threaded Filler Neck .....	10591		2005; Oil Filler Cap .....	10144	
1998-1997; Diesel Regular Locking Fuel Cap; W/Threaded Filler Neck .....	10591D		<b>4-Cyl. 2.3 L Electric Assist</b>		
1998-1997; Pre-Vent Non-Locking Fuel Cap; W/Threaded Filler Neck .....	10819		2008-2005; OE Type Radiator Cap .....	10251	17
1998-1997; Diesel Pre-Vent Non-Locking Fuel Cap; W/Threaded Filler Neck .....	10819D		2008-2005; OE Equivalent Fuel Cap .....	10840	
1998-1997; Pre-Vent Locking Fuel Cap; W/Threaded Filler Neck .....	10501		2008-2005; Regular Locking Fuel Cap .....	10510	
1998-1997; Diesel Only Pre-Vent Locking Fuel Cap; W/Threaded Filler Neck .....	10501D		2008-2005; Oil Filler Cap .....	10144	
<b>V-8 7.3 L Diesel</b>			<b>4-Cyl. 2.5 L</b>		
1998-1997; OE Type Radiator Cap .....	10238	16	2011; OE Type Radiator Cap .....	10251	17

## Caps for Passenger Cars and Light Trucks (1990 and Newer)

Application	Part Number	PSI	Application	Part Number	PSI
<b>Ford - Continued</b>			<b>Ford - Continued</b>		
<b>Escape - Continued</b>			<b>Excursion - Continued</b>		
<b>4-Cyl. 2.5 L - Continued</b>			<b>V-8 5.4 L</b>		
2010: OE Type Radiator Cap .....	10251	17	2005-2000: OE Type Radiator Cap .....	10238	16
2010: Oil Filler Cap .....	10117		2005-2000: OE Equivalent Fuel Cap .....	10832	
2009: OE Type Radiator Cap .....	10251	17	2005-2000: Regular Locking Fuel Cap .....	10502	
2005-2000: Oil Filler Cap .....			2005-2000: Oil Filler Cap .....	10081	
<b>4-Cyl. 2.5 L Electric Assist</b>			<b>V-8 6.0 L Diesel</b>		
2010-2009: OE Type Radiator Cap .....	10251	17	2005-2003: OE Type Radiator Cap .....	10238	16
<b>V-6 3.0 L</b>			2005-2003: OE Equivalent Fuel Cap; W/Threaded Filler Neck ...	10817	
2011: Oil Filler Cap .....	10117		2005-2003: Diesel Regular Non-Locking Fuel Cap; W/Threaded Filler Neck .....	10830D	
2010: OE Type Radiator Cap .....	10251	17	2005-2003: Regular Locking Fuel Cap; W/Threaded Filler Neck .....	10591	
2010: Oil Filler Cap .....	10117		2005-2003: Diesel Regular Locking Fuel Cap; W/Threaded Filler Neck .....	10591D	
2009: OE Type Radiator Cap .....	10251	17	2005-2003: Pre-Vent Non-Locking Fuel Cap; W/Threaded Filler Neck .....	10819	
2008-2005: OE Type Radiator Cap .....	10251	17	2005-2003: Diesel Pre-Vent Non-Locking Fuel Cap; W/Threaded Filler Neck .....	10819D	
2008-2005: OE Equivalent Fuel Cap .....	10840		2005-2003: Pre-Vent Locking Fuel Cap; W/Threaded Filler Neck .....	10501	
2008-2005: Regular Locking Fuel Cap .....	10510		2005-2003: Diesel Only Pre-Vent Locking Fuel Cap; W/Threaded Filler Neck .....	10501D	
2008-2005: Oil Filler Cap .....	10117		2005-2003: Oil Filler Cap .....	10081	
2004-2001: OE Type Radiator Cap .....	10251	17	<b>V-8 7.3 L Diesel</b>		
2004-2001: OE Equivalent Fuel Cap .....	10832		2003: OE Type Radiator Cap .....	10238	16
2004-2001: Regular Locking Fuel Cap .....	10502		2003: OE Equivalent Fuel Cap; W/Threaded Filler Neck .....	10817	
2004-2001: Oil Filler Cap .....	10117		2003: Diesel Regular Non-Locking Fuel Cap; W/Threaded Filler Neck .....	10830D	
<b>Escort</b>			2003: Regular Locking Fuel Cap; W/Threaded Filler Neck .....	10591	
<b>4-Cyl. 1.8 L</b>			2003: Diesel Regular Locking Fuel Cap; W/Threaded Filler Neck .....	10591D	
1996-1995: Lev-R-Vent Radiator Cap .....	✓10327	13	2003: Pre-Vent Non-Locking Fuel Cap; W/Threaded Filler Neck .....	10819	
1996-1995: OE Type Radiator Cap .....	10227	13	2003: Diesel Pre-Vent Non-Locking Fuel Cap; W/Threaded Filler Neck .....	10819D	
1996-1995: Pre-Vent Non-Locking Fuel Cap .....	10819		2003: Pre-Vent Locking Fuel Cap; W/Threaded Filler Neck .....	10501	
1996-1995: Pre-Vent Locking Fuel Cap .....	10501		2003: Diesel Only Pre-Vent Locking Fuel Cap; W/Threaded Filler Neck .....	10501D	
1996-1995: Oil Filler Cap .....	10082		2003: Oil Filler Cap .....	10081	
<b>4-Cyl. 1.9 L</b>			2002-2001: OE Type Radiator Cap .....	10238	16
1996-1995: Lev-R-Vent Radiator Cap .....	✓10327	13	2002-2001: OE Equivalent Fuel Cap; W/Threaded Filler Neck ...	10817	
1996-1995: OE Type Radiator Cap .....	10227	13	2002-2001: Diesel Regular Non-Locking Fuel Cap; W/Threaded Filler Neck .....	10830D	
1996-1995: Pre-Vent Non-Locking Fuel Cap .....	10819		2002-2001: Regular Locking Fuel Cap; W/Threaded Filler Neck .....	10591	
1996-1995: Pre-Vent Locking Fuel Cap .....	10501		2002-2001: Diesel Regular Locking Fuel Cap; W/Threaded Filler Neck .....	10591D	
1996-1995: Oil Filler Cap .....	10081		2002-2001: Pre-Vent Non-Locking Fuel Cap; W/Threaded Filler Neck .....	10819	
<b>4-Cyl. 2.0 L</b>			2002-2001: Diesel Pre-Vent Non-Locking Fuel Cap; W/Threaded Filler Neck .....	10819D	
2002: Lev-R-Vent Radiator Cap .....	✓10333	16	2002-2001: Pre-Vent Locking Fuel Cap; W/Threaded Filler Neck .....	10501	
2002: OE Type Radiator Cap .....	10233	16	2002-2001: Diesel Only Pre-Vent Locking Fuel Cap; W/Threaded Filler Neck .....	10501D	
2002: OE Equivalent Fuel Cap .....	10832		2002-2001: OE Equivalent Fuel Cap; W/O Threaded Filler Neck .....	10832	
2002: Regular Locking Fuel Cap .....	10502		2002-2001: Diesel Regular Non-Locking Fuel Cap; W/O Threaded Filler Neck .....	10832D	
2002: Oil Filler Cap; W/DOHC Eng. ....	10101		2002-2001: Regular Locking Fuel Cap; W/O Threaded Filler Neck .....	10502	
2001: Lev-R-Vent Radiator Cap .....	✓10333	16	2002-2001: Diesel Regular Locking Fuel Cap; W/O Threaded Filler Neck .....	10502D	
2001: OE Type Radiator Cap .....	10233	16	2002-2001: Oil Filler Cap .....	10081	
2001: OE Equivalent Fuel Cap .....	10832		2000: OE Type Radiator Cap .....	10238	16
2001: Regular Locking Fuel Cap .....	10502		2000: OE Equivalent Fuel Cap .....	10832	
2001: Oil Filler Cap; W/DOHC Eng. ....	10101		2000: Diesel Regular Non-Locking Fuel Cap .....	10832D	
2001: Oil Filler Cap; W/SOHC Eng. ....	10117		2000: Regular Locking Fuel Cap .....	10502	
2000: Lev-R-Vent Radiator Cap .....	✓10333	16	2000: Oil Filler Cap .....	10117	
2000: OE Type Radiator Cap .....	10233	16	<b>Expedition</b>		
2000: OE Equivalent Fuel Cap .....	10832		<b>V-8 4.6 L</b>		
2000: Regular Locking Fuel Cap .....	10502		2004: OE Type Radiator Cap .....	10238	16
2000: Oil Filler Cap .....	10117		2004: OE Equivalent Fuel Cap .....	10832	
1999: Lev-R-Vent Radiator Cap .....	✓10333	16	2004: Regular Locking Fuel Cap .....	10502	
1999: OE Type Radiator Cap .....	10233	16	2004: Oil Filler Cap .....	10081	
1999: OE Equivalent Fuel Cap .....	10832		2003: OE Type Radiator Cap .....	10238	16
1999: Regular Locking Fuel Cap .....	10502		2003: OE Equivalent Fuel Cap .....	10832	
1999: Oil Filler Cap .....	10081		2003: Regular Locking Fuel Cap .....	10502	
1998: Lev-R-Vent Radiator Cap .....	✓10333	16	2003: Oil Filler Cap .....	10117	
1998: OE Type Radiator Cap .....	10233	16	<b>Expedition</b>		
1998: OE Equivalent Fuel Cap .....	10832		<b>V-8 4.6 L</b>		
1998: Regular Locking Fuel Cap .....	10502		2004: OE Type Radiator Cap .....	10238	16
1998: Oil Filler Cap .....	10134		2004: OE Equivalent Fuel Cap .....	10832	
1997: Lev-R-Vent Radiator Cap .....	✓10333	16	2004: Regular Locking Fuel Cap .....	10502	
1997: OE Type Radiator Cap .....	10233	16	2004: Oil Filler Cap .....	10081	
1997: Pre-Vent Non-Locking Fuel Cap .....	10819		2003: OE Type Radiator Cap .....	10238	16
1997: Pre-Vent Locking Fuel Cap .....	10501		2003: OE Equivalent Fuel Cap .....	10832	
1997: Oil Filler Cap .....	10081		2003: Regular Locking Fuel Cap .....	10502	
<b>Excursion</b>			2003: Oil Filler Cap .....	10117	
<b>V-10 6.8 L</b>			<b>Expedition</b>		
2005-2000: OE Type Radiator Cap .....	10238	16	<b>V-8 4.6 L</b>		
2005-2000: OE Equivalent Fuel Cap .....	10832		2004: OE Type Radiator Cap .....	10238	16
2005-2000: Regular Locking Fuel Cap .....	10502		2004: OE Equivalent Fuel Cap .....	10832	
2005-2000: Oil Filler Cap .....	10081		2004: Regular Locking Fuel Cap .....	10502	
			2004: Oil Filler Cap .....	10081	
			2003: OE Type Radiator Cap .....	10238	16
			2003: OE Equivalent Fuel Cap .....	10832	
			2003: Regular Locking Fuel Cap .....	10502	
			2003: Oil Filler Cap .....	10117	

✓ Check Hood Clearance prior to installing this Cap.



## Caps for Passenger Cars and Light Trucks (1990 and Newer)

Application	Part Number	PSI	Application	Part Number	PSI
<b>Ford - Continued</b>			<b>Ford - Continued</b>		
<b>Expedition - Continued</b>			<b>Explorer - Continued</b>		
<b>V-8 4.6 L - Continued</b>			<b>V-6 4.0 L - Continued</b>		
2002-1997; OE Type Radiator Cap .....	10238	16	2000; Regular Locking Fuel Cap .....	10502	
2002-1997; OE Equivalent Fuel Cap .....	10832		2000; Oil Filler Cap; W/SOHC Eng. ....	10101	
2002-1997; Regular Locking Fuel Cap .....	10502		2000; Oil Filler Cap; W/O.H.V. Eng. ....	10081	
2002-1997; Oil Filler Cap .....	10081		1999; Lev-R-Vent Radiator Cap .....	✓10333	16
<b>V-8 5.4 L</b>			1999; OE Type Radiator Cap .....	10233	16
2011-2010; Lev-R-Vent Radiator Cap .....	10333	16	1999; OE Equivalent Fuel Cap .....	10832	
2011-2010; OE Type Radiator Cap .....	10233	16	1999; Regular Locking Fuel Cap .....	10502	
2011-2010; Oil Filler Cap .....	10117		1999; Oil Filler Cap; W/SOHC Eng. ....	10081	
2009; OE Type Radiator Cap .....	10233	16	1998-1997; Lev-R-Vent Radiator Cap .....	✓10333	16
2009; Oil Filler Cap .....	10117		1998-1997; OE Type Radiator Cap .....	10233	16
2008-2005; OE Type Radiator Cap .....	10238	16	1998-1997; OE Equivalent Fuel Cap .....	10832	
2008-2005; OE Equivalent Fuel Cap .....	10840		1998-1997; Regular Locking Fuel Cap .....	10502	
2008-2005; Regular Locking Fuel Cap .....	10510		1998-1997; Oil Filler Cap .....	10081	
2008-2005; Oil Filler Cap .....	10117		1996; Lev-R-Vent Radiator Cap .....	✓10333	16
2004; OE Type Radiator Cap .....	10238	16	1996; OE Type Radiator Cap .....	10233	16
2004; OE Equivalent Fuel Cap .....	10832		1996; OE Equivalent Fuel Cap .....	10833	
2004; Regular Locking Fuel Cap .....	10502		1996; Regular Locking Fuel Cap .....	10503	
2004; Oil Filler Cap; W/Threaded Filler Neck .....	10081		1996; Oil Filler Cap .....	10081	
2004; Oil Filler Cap; W/O Threaded Filler Neck .....	10117		1995; Lev-R-Vent Radiator Cap .....	✓10333	16
2003-1997; OE Type Radiator Cap .....	10238	16	1995; OE Type Radiator Cap .....	10233	16
2003-1997; OE Equivalent Fuel Cap .....	10832		1995; Pre-Vent Non-Locking Fuel Cap .....	10819	
2003-1997; Regular Locking Fuel Cap .....	10502		1995; Pre-Vent Locking Fuel Cap .....	10501	
2003-1997; Oil Filler Cap .....	10081		1995; Oil Filler Cap .....	10081	
<b>Explorer</b>			<b>V-8 4.6 L</b>		
<b>V-6 3.5 L</b>			2010-2009; OE Type Radiator Cap .....	10267	20
2011; OE Type Radiator Cap .....	10238	16	2010-2009; Oil Filler Cap .....	10117	
2011; Oil Filler Cap .....	10117		2008-2006; OE Type Radiator Cap .....	10267	20
<b>V-6 4.0 L</b>			2008-2006; OE Equivalent Fuel Cap .....	10840	
2010-2009; OE Type Radiator Cap .....	10267	20	2008-2006; Regular Locking Fuel Cap .....	10510	
2010-2009; Oil Filler Cap .....	10117		2008-2006; Oil Filler Cap .....	10117	
2008-2006; OE Type Radiator Cap .....	10267	20	2005; OE Type Radiator Cap .....	10238	16
2008-2006; OE Equivalent Fuel Cap .....	10840		2005; OE Equivalent Fuel Cap .....	10840	
2008-2006; Regular Locking Fuel Cap .....	10510		2005; Regular Locking Fuel Cap .....	10510	
2008-2006; Oil Filler Cap .....	10117		2005; Oil Filler Cap .....	10117	
2005; OE Type Radiator Cap .....	10238	16	2004; OE Type Radiator Cap .....	10238	16
2005; OE Equivalent Fuel Cap; Eng. VIN E .....	10840		2004; OE Equivalent Fuel Cap; For Black Bottom O.E. Cap .....	10832	
2005; Regular Locking Fuel Cap; Eng. VIN E .....	10510		2004; Regular Locking Fuel Cap; For Black Bottom O.E. Cap .....	10502	
2005; OE Equivalent Fuel Cap; Eng. VIN K .....	10840		2004; OE Equivalent Fuel Cap; For White Bottom O.E. Cap .....	10840	
2005; Regular Locking Fuel Cap; Eng. VIN K .....	10510		W/Orange O-Ring Seal .....	10840	
2005; Flex Fuel Regular Fuel Cap; Eng. VIN K .....	10840Y		2004; Regular Locking Fuel Cap; For White Bottom O.E. Cap .....	10510	
2005; Flex Fuel Regular Locking Fuel Cap; Eng. VIN K .....	10510Y		W/Orange O-Ring Seal .....	10510	
2005; Oil Filler Cap .....	10117		2004; Oil Filler Cap .....	10117	
2004; OE Type Radiator Cap .....	10238	16	2003; OE Type Radiator Cap .....	10238	16
2004; OE Equivalent Fuel Cap; For Black Bottom O.E. Cap .....	10832		2003; OE Equivalent Fuel Cap .....	10832	
2004; Regular Locking Fuel Cap; For Black Bottom O.E. Cap .....	10502		2003; Regular Locking Fuel Cap .....	10502	
2004; OE Equivalent Fuel Cap; For White Bottom O.E. Cap .....	10840		2003; Oil Filler Cap .....	10117	
W/Orange O-Ring Seal .....	10840		2002; OE Type Radiator Cap .....	10238	16
2004; Regular Locking Fuel Cap; For White Bottom O.E. Cap .....	10510		2002; OE Equivalent Fuel Cap .....	10832	
W/Orange O-Ring Seal .....	10510		2002; Regular Locking Fuel Cap .....	10502	
2004; Flex Fuel Regular Fuel Cap; Eng. VIN K; For Black Bottom O.E. Cap .....	10832Y		2002; Oil Filler Cap .....	10081	
2004; Flex Fuel Regular Locking Fuel Cap; Eng. VIN K; For Black Bottom O.E. Cap .....	10502Y		<b>V-8 5.0 L</b>		
2004; Flex Fuel Regular Locking Fuel Cap -Ring Seal; Eng. VIN K; For White Bottom O.E. Cap W/Orange O-Ring Seal .....	10510Y		2001-1999; Lev-R-Vent Radiator Cap .....	✓10333	16
2004; Flex Fuel Regular Fuel Cap -Ring Seal; Eng. VIN K; For White Bottom O.E. Cap W/Orange O-Ring Seal .....	10840Y		2001-1999; OE Type Radiator Cap .....	10233	16
2004; Oil Filler Cap .....	10117		2001-1999; OE Equivalent Fuel Cap .....	10832	
2003-2002; OE Type Radiator Cap .....	10238	16	2001-1999; Regular Locking Fuel Cap .....	10502	
2003-2002; OE Equivalent Fuel Cap .....	10832		2001-1999; Oil Filler Cap .....	10081	
2003-2002; Flex Fuel Regular Fuel Cap .....	10832Y		1998; Lev-R-Vent Radiator Cap .....	10329	13
2003-2002; Regular Locking Fuel Cap .....	10502		1998; OE Type Radiator Cap .....	10229	13
2003-2002; Flex Fuel Regular Locking Fuel Cap .....	10502Y		1998; OE Equivalent Fuel Cap .....	10832	
2003-2002; Oil Filler Cap .....	10117		1998; Regular Locking Fuel Cap .....	10502	
2001; Lev-R-Vent Radiator Cap .....	✓10333	16	1998; Oil Filler Cap .....	10081	
2001; OE Type Radiator Cap .....	10233	16	1997; Lev-R-Vent Radiator Cap .....	✓10333	16
2001; OE Equivalent Fuel Cap .....	10832		1997; OE Type Radiator Cap .....	10233	16
2001; Regular Locking Fuel Cap .....	10502		1997; OE Equivalent Fuel Cap .....	10832	
2001; Oil Filler Cap; Dec. 31, 2000 & Older; W/SOHC Eng. ....	10101		1997; Regular Locking Fuel Cap .....	10502	
2000; Lev-R-Vent Radiator Cap .....	✓10333	16	1997; Oil Filler Cap .....	10081	
2000; OE Type Radiator Cap .....	10233	16	1996; Lev-R-Vent Radiator Cap .....	✓10333	16
2000; OE Equivalent Fuel Cap .....	10832		1996; OE Type Radiator Cap .....	10233	16
			1996; OE Equivalent Fuel Cap .....	10833	
			1996; Regular Locking Fuel Cap .....	10503	
			1996; Oil Filler Cap .....	10081	

✓ Check Hood Clearance prior to installing this Cap.

## Caps for Passenger Cars and Light Trucks (1990 and Newer)

Application	Part Number	PSI	Application	Part Number	PSI
<b>Ford - Continued</b>			<b>Ford - Continued</b>		
<b>Explorer Sport Trac</b>			<b>F Series Pickup - Continued</b>		
<b>V-6 4.0 L</b>			<b>V-6 4.2 L - Continued</b>		
2010-2008: OE Type Radiator Cap .....	10267	20	1997: Oil Filler Cap .....	10081	
2010-2008: OE Equivalent Fuel Cap .....	10840		<b>V-8 4.6 L</b>		
2010-2008: Regular Locking Fuel Cap .....	10510		2010: Lev-R-Vent Radiator Cap .....	10333	16
2010-2008: Oil Filler Cap .....	10117		2010: OE Type Radiator Cap .....	10233	16
2007: OE Type Radiator Cap .....	10267	20	2010: Oil Filler Cap .....	10117	
2007: OE Equivalent Fuel Cap .....	10840		2009: OE Type Radiator Cap .....	10233	16
2007: Regular Locking Fuel Cap .....	10510		2009: Oil Filler Cap .....	10117	
2005: Lev-R-Vent Radiator Cap .....	✓10333	16	2008-2005: OE Type Radiator Cap .....	10238	16
2005: OE Type Radiator Cap .....	10233	16	2008-2005: OE Equivalent Fuel Cap .....	10840	
2005: OE Equivalent Fuel Cap .....	10840		2008-2005: Regular Locking Fuel Cap .....	10510	
2005: Regular Locking Fuel Cap .....	10510		2008-2005: Oil Filler Cap .....	10117	
2005: Oil Filler Cap .....	10117		2004: OE Type Radiator Cap .....	10238	16
2004: Lev-R-Vent Radiator Cap .....	✓10333	16	2004: OE Equivalent Fuel Cap; For Black Bottom O.E. Cap .....	10832	
2004: OE Type Radiator Cap .....	10233	16	2004: Regular Locking Fuel Cap; For Black Bottom O.E. Cap .....	10502	
2004: OE Equivalent Fuel Cap; For Black Bottom O.E. Cap .....	10832		2004: OE Equivalent Fuel Cap; For White Bottom O.E. Cap .....		
2004: Regular Locking Fuel Cap; For Black Bottom O.E. Cap .....	10502		W/Orange O-Ring Seal .....	10840	
2004: OE Equivalent Fuel Cap; For White Bottom O.E. Cap .....			2004: Regular Locking Fuel Cap; For White Bottom O.E. Cap .....		
W/Orange O-Ring Seal .....	10840		W/Orange O-Ring Seal .....	10510	
2004: Regular Locking Fuel Cap; For White Bottom O.E. Cap .....			2004: Oil Filler Cap .....	10117	
W/Orange O-Ring Seal .....	10510		2003-1998: OE Type Radiator Cap .....	10238	16
2004: Oil Filler Cap .....	10117		2003-1998: OE Equivalent Fuel Cap .....	10832	
2003-2002: Lev-R-Vent Radiator Cap .....	✓10333	16	2003-1998: Regular Locking Fuel Cap .....	10502	
2003-2002: OE Type Radiator Cap .....	10233	16	2003-1998: Oil Filler Cap .....	10081	
2003-2002: OE Equivalent Fuel Cap .....	10832		1997: OE Type Radiator Cap .....	10238	16
2003-2002: Regular Locking Fuel Cap .....	10502		1997: OE Equivalent Fuel Cap; W/Threaded Filler Neck .....	10833	
2003-2002: Oil Filler Cap .....	10117		1997: Regular Locking Fuel Cap; W/Threaded Filler Neck .....	10503	
2001: Lev-R-Vent Radiator Cap .....	✓10333	16	1997: OE Equivalent Fuel Cap; W/O Threaded Filler Neck .....	10832	
2001: OE Type Radiator Cap .....	10233	16	1997: Regular Locking Fuel Cap; W/O Threaded Filler Neck .....	10502	
2001: OE Equivalent Fuel Cap .....	10832		1997: Oil Filler Cap .....	10081	
2001: Regular Locking Fuel Cap .....	10502		<b>V-8 5.0 L</b>		
2001: Oil Filler Cap; Dec. 31, 2000 & Older .....	10101		2011: OE Type Radiator Cap .....	10238	16
<b>V-8 4.6 L</b>			2011: Oil Filler Cap .....	10117	
2010-2008: OE Type Radiator Cap .....	10267	20	1996-1995: Lev-R-Vent Radiator Cap .....	10329	13
2010-2008: OE Equivalent Fuel Cap .....	10840		1996-1995: OE Type Radiator Cap .....	10229	13
2010-2008: Regular Locking Fuel Cap .....	10510		1996-1995: Pre-Vent Non-Locking Fuel Cap .....	10819	
2010-2008: Oil Filler Cap .....	10117		1996-1995: Pre-Vent Locking Fuel Cap .....	10501	
2007: OE Type Radiator Cap .....	10267	20	1996-1995: Oil Filler Cap .....	10081	
2007: OE Equivalent Fuel Cap .....	10840		<b>V-8 5.4 L</b>		
2007: Regular Locking Fuel Cap .....	10510		2010: Lev-R-Vent Radiator Cap .....	10333	16
<b>F Series Pickup</b>			2010: OE Type Radiator Cap .....	10233	16
<b>6-Cyl. 4.9 L</b>			2010: Oil Filler Cap .....	10117	
1996-1995: Lev-R-Vent Radiator Cap .....	10329	13	2009: OE Type Radiator Cap .....	10233	16
1996-1995: OE Type Radiator Cap .....	10229	13	2009: Oil Filler Cap .....	10117	
1996-1995: Pre-Vent Non-Locking Fuel Cap .....	10819		2008-2006: OE Type Radiator Cap .....	10238	16
1996-1995: Pre-Vent Locking Fuel Cap .....	10501		2008-2006: OE Equivalent Fuel Cap .....	10840	
1996-1995: Oil Filler Cap .....	10081		2008-2006: Regular Locking Fuel Cap .....	10510	
<b>V-6 3.5 L; V-6 3.7 L</b>			2008-2006: Oil Filler Cap .....	10117	
2011: OE Type Radiator Cap .....	10238	16	2005: OE Type Radiator Cap .....	10238	16
2011: Oil Filler Cap .....	10117		2005: OE Equivalent Fuel Cap .....	10840	
<b>V-6 4.2 L</b>			2005: Regular Locking Fuel Cap .....	10510	
2008-2005: OE Type Radiator Cap .....	10238	16	2005: Oil Filler Cap; W/Threaded Filler Neck .....	10081	
2008-2005: OE Equivalent Fuel Cap .....	10840		2005: Oil Filler Cap; W/O Threaded Filler Neck .....	10117	
2008-2005: Regular Locking Fuel Cap .....	10510		2004: OE Type Radiator Cap .....	10238	16
2008-2005: Oil Filler Cap .....	10081		2004: OE Equivalent Fuel Cap; For Black Bottom O.E. Cap .....	10832	
2004: OE Type Radiator Cap .....	10238	16	2004: Regular Locking Fuel Cap; For Black Bottom O.E. Cap .....	10502	
2004: OE Equivalent Fuel Cap; For Black Bottom O.E. Cap .....	10832		2004: OE Equivalent Fuel Cap; For White Bottom O.E. Cap .....		
2004: Regular Locking Fuel Cap; For Black Bottom O.E. Cap .....	10502		W/Orange O-Ring Seal .....	10840	
2004: OE Equivalent Fuel Cap; For White Bottom O.E. Cap .....			2004: Regular Locking Fuel Cap; For White Bottom O.E. Cap .....		
W/Orange O-Ring Seal .....	10840		W/Orange O-Ring Seal .....	10510	
2004: Regular Locking Fuel Cap; For White Bottom O.E. Cap .....			2004: Oil Filler Cap; W/Threaded Filler Neck .....	10081	
W/Orange O-Ring Seal .....	10510		2004: Oil Filler Cap; W/O Threaded Filler Neck .....	10117	
2004: Oil Filler Cap .....	10081		2003: OE Type Radiator Cap .....	10238	16
2003-1998: OE Type Radiator Cap .....	10238	16	2003: Pre-Vent Non-Locking Fuel Cap; W/Threaded Filler Neck .....	10819	
2003-1998: OE Equivalent Fuel Cap .....	10832		2003: Pre-Vent Locking Fuel Cap; W/Threaded Filler Neck .....	10501	
2003-1998: Regular Locking Fuel Cap .....	10502		2003: OE Equivalent Fuel Cap; W/O Threaded Filler Neck .....	10832	
2003-1998: Oil Filler Cap .....	10081		2003: Regular Locking Fuel Cap; W/O Threaded Filler Neck .....	10502	
1997: OE Type Radiator Cap .....	10238	16	2003: Oil Filler Cap; W/Threaded Filler Neck .....	10081	
1997: OE Equivalent Fuel Cap; W/Threaded Filler Neck .....	10833		2003: Oil Filler Cap; W/O Threaded Filler Neck .....	10117	
1997: Regular Locking Fuel Cap; W/Threaded Filler Neck .....	10503		2002: OE Type Radiator Cap .....	10238	16
1997: OE Equivalent Fuel Cap; W/O Threaded Filler Neck .....	10832		2002: Pre-Vent Non-Locking Fuel Cap; W/Threaded Filler Neck .....	10819	
1997: Regular Locking Fuel Cap; W/O Threaded Filler Neck .....	10502		2002: Pre-Vent Locking Fuel Cap; W/Threaded Filler Neck .....	10501	
			2002: OE Equivalent Fuel Cap; W/O Threaded Filler Neck .....	10832	

✓ Check Hood Clearance prior to installing this Cap.

## Caps for Passenger Cars and Light Trucks (1990 and Newer)

Application	Part Number	PSI	Application	Part Number	PSI
<b>Ford - Continued</b>			<b>Ford - Continued</b>		
<b>F Series Pickup - Continued</b>			<b>Five Hundred</b>		
<b>V-8 5.4 L - Continued</b>			<b>V-6 3.0 L</b>		
2002; Flex Fuel Regular Fuel Cap; W/O Threaded Filler Neck ...	10832Y		2007-2005; OE Type Radiator Cap .....	10238	16
2002; Regular Locking Fuel Cap; W/O Threaded Filler Neck .....	10502		2007-2005; OE Equivalent Fuel Cap .....	10840	
2002; Flex Fuel Regular Locking Fuel Cap; W/O Threaded Filler Neck .....	10502Y		2007-2005; Regular Locking Fuel Cap .....	10510	
2002; Oil Filler Cap .....	10081		2007-2005; Oil Filler Cap .....	10117	
2001; OE Type Radiator Cap .....	10238	16	<b>Flex</b>		
2001; OE Equivalent Fuel Cap .....	10832		<b>V-6 3.5 L</b>		
2001; Flex Fuel Regular Fuel Cap .....	10832Y		2011-2009; OE Type Radiator Cap .....	10238	16
2001; Regular Locking Fuel Cap .....	10502		2011-2009; Oil Filler Cap .....	10117	
2001; Flex Fuel Regular Locking Fuel Cap .....	10502Y		<b>Focus</b>		
2001; Oil Filler Cap .....	10081		<b>4-Cyl. 2.0 L</b>		
2000; OE Type Radiator Cap .....	10238	16	2011-2009; OE Type Radiator Cap .....	10265	18
2000; OE Equivalent Fuel Cap; W/O Threaded Filler Neck .....	10832		2011-2009; Coolant Recovery Tank Cap .....	10261	
2000; Flex Fuel Regular Fuel Cap; W/O Threaded Filler Neck ...	10832Y		2011-2009; OE Equivalent Fuel Cap .....	10840	
2000; Regular Locking Fuel Cap; W/O Threaded Filler Neck .....	10502		2011-2009; Regular Locking Fuel Cap .....	10510	
2000; Flex Fuel Regular Locking Fuel Cap; W/O Threaded Filler Neck .....	10502Y		2008; Coolant Recovery Tank Cap .....	10238	
2000; Pre-Vent Non-Locking Fuel Cap; W/Threaded Filler Neck .....	10819		2008; OE Type Radiator Cap .....	10265	18
2000; Pre-Vent Locking Fuel Cap; W/Threaded Filler Neck .....	10501		2008; OE Equivalent Fuel Cap .....	10840	
2000; Oil Filler Cap .....	10081		2008; Regular Locking Fuel Cap .....	10510	
1999; OE Type Radiator Cap .....	10238	16	2008; Oil Filler Cap .....	10144	
1999; OE Equivalent Fuel Cap .....	10832		2007-2006; OE Type Radiator Cap .....	10238	16
1999; Flex Fuel Regular Fuel Cap .....	10832Y		2007-2006; OE Equivalent Fuel Cap .....	10840	
1999; Regular Locking Fuel Cap .....	10502		2007-2006; Regular Locking Fuel Cap .....	10510	
1999; Flex Fuel Regular Locking Fuel Cap .....	10502Y		2007-2006; Oil Filler Cap .....	10144	
1999; Oil Filler Cap .....	10081		2005; OE Type Radiator Cap .....	10250	18
1998; OE Type Radiator Cap .....	10238	16	2005; OE Equivalent Fuel Cap .....	10840	
1998; OE Equivalent Fuel Cap .....	10832		2005; Regular Locking Fuel Cap .....	10510	
1998; Regular Locking Fuel Cap .....	10502		2005; Oil Filler Cap .....	10144	
1998; Oil Filler Cap .....	10081		2004; OE Type Radiator Cap .....	10250	18
1997; OE Type Radiator Cap .....	10238	16	2004; OE Equivalent Fuel Cap .....	10837	
1997; OE Equivalent Fuel Cap; W/Threaded Filler Neck .....	10833		2004; Regular Locking Fuel Cap .....	10507	
1997; Regular Locking Fuel Cap; W/Threaded Filler Neck .....	10503		2004; Oil Filler Cap; Eng. VIN 5 .....	10081	
1997; OE Equivalent Fuel Cap; W/O Threaded Filler Neck .....	10832		2004; Oil Filler Cap; Eng. VIN 3; W/Threaded Filler Neck .....	10101	
1997; Regular Locking Fuel Cap; W/O Threaded Filler Neck .....	10502		2003; OE Type Radiator Cap .....	10250	18
1997; Oil Filler Cap .....	10081		2003; OE Equivalent Fuel Cap .....	10837	
<b>V-8 5.8 L</b>			2003; Regular Locking Fuel Cap .....	10507	
1997-1995; Lev-R-Vent Radiator Cap .....	10329	13	2003; Oil Filler Cap; Eng. VIN P .....	10117	
1997-1995; OE Type Radiator Cap .....	10229	13	2003; Oil Filler Cap; Eng. VIN 3, 5; W/Threaded Filler Neck .....	10101	
1997-1995; Pre-Vent Non-Locking Fuel Cap .....	10819		2002; OE Type Radiator Cap .....	10250	18
1997-1995; Pre-Vent Locking Fuel Cap .....	10501		2002; OE Equivalent Fuel Cap .....	10837	
1997-1995; Oil Filler Cap .....	10081		2002; Regular Locking Fuel Cap .....	10507	
<b>V-8 6.2 L</b>			2002; Oil Filler Cap; Eng. VIN P .....	10117	
2011; Lev-R-Vent Radiator Cap .....	10333	16	2002; Oil Filler Cap; Eng. VIN 3; W/Threaded Filler Neck .....	10101	
2011; OE Type Radiator Cap .....	10233	16	2001; OE Type Radiator Cap .....	10250	18
2011; Oil Filler Cap .....	10117		2001; OE Equivalent Fuel Cap .....	10837	
2010; Oil Filler Cap .....	10117		2001; Regular Locking Fuel Cap .....	10507	
<b>V-8 7.3 L Diesel</b>			2001; Oil Filler Cap; W/DOHC Eng. ....	10101	
1997-1995; OE Type Radiator Cap .....	10238	16	2001; Oil Filler Cap; W/SOHC Eng. ....	10117	
1997-1995; OE Equivalent Fuel Cap .....	10817		2000; OE Type Radiator Cap .....	10250	18
1997-1995; Diesel Regular Non-Locking Fuel Cap .....	10830D		2000; OE Equivalent Fuel Cap .....	10837	
1997-1995; Regular Locking Fuel Cap .....	10591		2000; Regular Locking Fuel Cap .....	10507	
1997-1995; Diesel Regular Locking Fuel Cap .....	10591D		2000; Oil Filler Cap; Eng. VIN 3 .....	10101	
1997-1995; Pre-Vent Non-Locking Fuel Cap .....	10819		2000; Oil Filler Cap; Eng. VIN P .....	10117	
1997-1995; Diesel Pre-Vent Non-Locking Fuel Cap .....	10819D		<b>4-Cyl. 2.3 L</b>		
1997-1995; Pre-Vent Locking Fuel Cap .....	10501		2007-2006; OE Type Radiator Cap .....	10238	16
1997-1995; Diesel Only Pre-Vent Locking Fuel Cap .....	10501D		2007-2006; OE Equivalent Fuel Cap .....	10840	
1997-1995; Oil Filler Cap .....	10081		2007-2006; Regular Locking Fuel Cap .....	10510	
<b>V-8 7.5 L</b>			2007-2006; Oil Filler Cap .....	10144	
1997-1996; Lev-R-Vent Radiator Cap .....	10329	13	2005; OE Type Radiator Cap .....	10238	16
1997-1996; OE Type Radiator Cap .....	10229	13	2005; OE Equivalent Fuel Cap .....	10840	
1997-1996; Pre-Vent Non-Locking Fuel Cap .....	10819		2005; Regular Locking Fuel Cap .....	10510	
1997-1996; Pre-Vent Locking Fuel Cap .....	10501		2004; OE Type Radiator Cap .....	10250	18
1997-1996; Oil Filler Cap; W/Oil Filler Tube .....	10081		2004; OE Equivalent Fuel Cap; W/O Threaded Filler Neck .....	10840	
1997-1996; Oil Breather Cap; W/O Oil Filler Tube .....	10071		2004; Regular Locking Fuel Cap; W/O Threaded Filler Neck .....	10510	
1995; Lev-R-Vent Radiator Cap .....	10329	13	2004; OE Equivalent Fuel Cap; W/Threaded Filler Neck .....	10837	
1995; OE Type Radiator Cap .....	10229	13	2004; Regular Locking Fuel Cap; W/Threaded Filler Neck .....	10507	
1995; Pre-Vent Non-Locking Fuel Cap; W/O Stripped Chassis ...	10819		2004; Oil Filler Cap .....	10144	
1995; Pre-Vent Locking Fuel Cap; W/O Stripped Chassis .....	10501		2003; OE Type Radiator Cap .....	10250	18
1995; Pre-Vent Non-Locking Fuel Cap; W/F53 Stripped Chassis	10821		2003; OE Equivalent Fuel Cap .....	10832	
1995; Oil Filler Cap; W/Oil Filler Tube .....	10081		2003; Regular Locking Fuel Cap .....	10502	
1995; Oil Breather Cap; W/O Oil Filler Tube .....	10071				

## Caps for Passenger Cars and Light Trucks (1990 and Newer)

Application	Part Number	PSI	Application	Part Number	PSI
<b>Ford - Continued</b>			<b>Ford - Continued</b>		
<b>Freestar</b>			<b>Mustang - Continued</b>		
V-6 3.9 L; V-6 4.2 L			V-6 3.8 L - Continued		
2007-2004: OE Type Radiator Cap .....	10238	16	1996: Pre-Vent Locking Fuel Cap .....	10501	
2007-2004: OE Equivalent Fuel Cap .....	10840		1996: Oil Filler Cap .....	10081	
2007-2004: Regular Locking Fuel Cap .....	10510		1995: Lev-R-Vent Radiator Cap .....	10331	16
2007-2004: Oil Filler Cap .....	10081		1995: OE Type Radiator Cap .....	10231	16
<b>Freestyle</b>			1995: Pre-Vent Non-Locking Fuel Cap .....		
V-6 3.0 L			1995: Pre-Vent Locking Fuel Cap .....		
2007-2005: OE Type Radiator Cap .....	10238	16	1995: Oil Filler Cap .....	10081	
2007-2005: OE Equivalent Fuel Cap .....	10840		V-6 3.9 L		
2007-2005: Regular Locking Fuel Cap .....	10510		2004: Lev-R-Vent Radiator Cap .....	✓10333	16
2007-2005: Oil Filler Cap .....	10117		2004: OE Type Radiator Cap .....	10233	16
<b>Fusion</b>			2004: OE Equivalent Fuel Cap .....		
4-Cyl. 2.3 L			2004: Regular Locking Fuel Cap .....		
2009-2008: OE Type Radiator Cap .....	10238	16	V-6 4.0 L		
2009-2008: OE Equivalent Fuel Cap .....	10840		2010: OE Type Radiator Cap .....		
2009-2008: Regular Locking Fuel Cap .....	10510		2010: Oil Filler Cap .....		
2007-2006: OE Type Radiator Cap .....	10238	16	2009-2005: OE Type Radiator Cap .....		
2007-2006: OE Equivalent Fuel Cap .....	10840		2009-2005: OE Equivalent Fuel Cap .....		
2007-2006: Regular Locking Fuel Cap .....	10510		2009-2005: Regular Locking Fuel Cap .....		
2007-2006: Oil Filler Cap .....	10144		2009-2005: Oil Filler Cap .....		
4-Cyl. 2.5 L			V-8 4.6 L		
2011-2010: OE Type Radiator Cap .....	10238	16	2010: OE Type Radiator Cap .....		
4-Cyl. 2.5 L Electric Assist			2010: Oil Filler Cap .....		
2010: OE Type Radiator Cap .....	10238	16	2009-2005: OE Type Radiator Cap .....		
V-6 3.0 L			2009-2005: OE Equivalent Fuel Cap .....		
2011-2010: OE Type Radiator Cap .....	10238	16	2009-2005: Regular Locking Fuel Cap .....		
2011-2010: Oil Filler Cap .....	10117		2009-2005: Oil Filler Cap .....		
2009-2006: OE Type Radiator Cap .....	10238	16	2004-2003: OE Type Radiator Cap .....		
2009-2006: OE Equivalent Fuel Cap .....	10840		2004-2003: OE Equivalent Fuel Cap .....		
2009-2006: Regular Locking Fuel Cap .....	10510		2004-2003: Regular Locking Fuel Cap .....		
2009-2006: Oil Filler Cap .....	10117		2004-2003: Oil Filler Cap: Eng. VIN R, Y .....		
V-6 3.5 L			2004-2003: Oil Filler Cap: Eng. VIN X .....		
2011-2010: OE Type Radiator Cap .....	10238	16	2002-1999: OE Type Radiator Cap .....		
2011-2010: Oil Filler Cap .....	10117		2002-1999: OE Equivalent Fuel Cap .....		
<b>GT</b>			2002-1999: Regular Locking Fuel Cap .....		
V-8 5.4 L			2002-1999: Oil Filler Cap .....		
2006: OE Type Radiator Cap .....	②10238	16	1998: OE Type Radiator Cap .....		
2006: Oil Filler Cap .....	10081		1998: Pre-Vent Non-Locking Fuel Cap -On Fuel Cap; W/O Snap-On Fuel Cap .....		
2005: OE Type Radiator Cap .....	10238	16	1998: Pre-Vent Locking Fuel Cap -On Fuel Cap; W/O Snap-On Fuel Cap .....		
2005: Oil Filler Cap .....	10081		1998: OE Equivalent Fuel Cap -On Fuel Cap; W/Snap-On Fuel Cap .....		
<b>Mustang</b>			1998: Regular Locking Fuel Cap -On Fuel Cap; W/Snap-On Fuel Cap .....		
V-6 3.7 L			1998: Oil Filler Cap .....		
2011: OE Type Radiator Cap .....	10238	16	1997-1996: OE Type Radiator Cap .....		
2011: Oil Filler Cap .....	10117		1997-1996: Pre-Vent Non-Locking Fuel Cap .....		
V-6 3.8 L			1997-1996: Pre-Vent Locking Fuel Cap .....		
2004-1999: Lev-R-Vent Radiator Cap .....	✓10333	16	1997-1996: Oil Filler Cap .....		
2004-1999: OE Type Radiator Cap .....	10233	16	V-8 5.0 L		
2004-1999: OE Equivalent Fuel Cap .....	10832		2011: OE Type Radiator Cap .....		
2004-1999: Regular Locking Fuel Cap .....	10502		2011: Oil Filler Cap .....		
2004-1999: Oil Filler Cap .....	10081		1995: Lev-R-Vent Radiator Cap .....		
1998: Lev-R-Vent Radiator Cap .....	✓10333	16	1995: OE Type Radiator Cap .....		
1998: OE Type Radiator Cap .....	10233	16	1995: Pre-Vent Non-Locking Fuel Cap .....		
1998: Pre-Vent Non-Locking Fuel Cap -On Fuel Cap; W/O Snap-On Fuel Cap .....	10819		1995: Pre-Vent Locking Fuel Cap .....		
1998: Pre-Vent Locking Fuel Cap -On Fuel Cap; W/O Snap-On Fuel Cap .....	10501		1995: Oil Filler Cap .....		
1998: OE Equivalent Fuel Cap -On Fuel Cap; W/Snap-On Fuel Cap .....	10832		V-8 5.4 L		
1998: Regular Locking Fuel Cap -On Fuel Cap; W/Snap-On Fuel Cap .....	10502		2011-2010: OE Type Radiator Cap .....		
1998: Oil Filler Cap .....	10081		2011-2010: Oil Filler Cap .....		
1997: Lev-R-Vent Radiator Cap .....	✓10333	16	2009-2007: OE Type Radiator Cap .....		
1997: OE Type Radiator Cap .....	10233	16	2009-2007: OE Equivalent Fuel Cap .....		
1997: Pre-Vent Non-Locking Fuel Cap .....	10819		2009-2007: Regular Locking Fuel Cap .....		
1997: Pre-Vent Locking Fuel Cap .....	10501		2009-2007: Oil Filler Cap .....		
1997: Oil Filler Cap .....	10081		2000: OE Equivalent Fuel Cap .....		
1996: Lev-R-Vent Radiator Cap .....	10330	16	2000: Regular Locking Fuel Cap .....		
1996: OE Type Radiator Cap .....	10230	16	2000: Oil Filler Cap .....		
1996: Pre-Vent Non-Locking Fuel Cap .....	10819		<b>Probe</b>		
			4-Cyl. 2.0 L		
			1997-1995: Lev-R-Vent Radiator Cap .....		
			1997-1995: OE Type Radiator Cap .....		

## Caps for Passenger Cars and Light Trucks (1990 and Newer)

Application	Part Number	PSI	Application	Part Number	PSI
<b>Ford - Continued</b>			<b>Ford - Continued</b>		
<b>Probe - Continued</b>			<b>Ranger - Continued</b>		
<b>4-Cyl. 2.0 L - Continued</b>			<b>V-6 3.0 L - Continued</b>		
1997-1995: Pre-Vent Non-Locking Fuel Cap .....	10819		2006-2005: Regular Locking Fuel Cap .....	10510	
1997-1995: Pre-Vent Locking Fuel Cap .....	10501		2006-2005: Oil Filler Cap .....	10117	
1997-1995: Oil Filler Cap .....	10082		2004: Lev-R-Vent Radiator Cap .....	✓10333	16
<b>V-6 2.5 L</b>			2004: OE Type Radiator Cap .....	10233	16
1997-1995: Lev-R-Vent Radiator Cap .....	✓10327	13	2004: OE Equivalent Fuel Cap .....	10840	
1997-1995: OE Type Radiator Cap .....	10227	13	2004: Flex Fuel Regular Fuel Cap .....	10840Y	
1997-1995: Pre-Vent Non-Locking Fuel Cap .....	10819		2004: Regular Locking Fuel Cap .....	10510	
1997-1995: Pre-Vent Locking Fuel Cap .....	10501		2004: Flex Fuel Regular Locking Fuel Cap .....	10510Y	
1997-1995: Oil Filler Cap .....	10082		2004: Oil Filler Cap .....	10117	
<b>Ranger</b>			2003-2001: Lev-R-Vent Radiator Cap .....	✓10333	16
<b>4-Cyl. 2.3 L</b>			2003-2001: OE Type Radiator Cap .....	10233	16
2011-2010: OE Type Radiator Cap .....	10238	16	2003-2001: OE Equivalent Fuel Cap .....	10832	
2011-2010: OE Equivalent Fuel Cap .....	10838		2003-2001: Flex Fuel Regular Fuel Cap .....	10832Y	
2011-2010: Regular Locking Fuel Cap .....	10508		2003-2001: Regular Locking Fuel Cap .....	10502	
2009: OE Type Radiator Cap .....	10238	16	2003-2001: Flex Fuel Regular Locking Fuel Cap .....	10502Y	
2009: OE Equivalent Fuel Cap .....	10840		2003-2001: Oil Filler Cap .....	10117	
2009: Regular Locking Fuel Cap .....	10510		2000-1999: Lev-R-Vent Radiator Cap .....	✓10333	16
2009: Oil Filler Cap .....	10144		2000-1999: OE Type Radiator Cap .....	10233	16
2008: OE Type Radiator Cap .....	10238	16	2000-1999: OE Equivalent Fuel Cap .....	10832	
2008: OE Equivalent Fuel Cap .....	10840		2000-1999: Flex Fuel Regular Fuel Cap .....	10832Y	
2008: Regular Locking Fuel Cap .....	10510		2000-1999: Regular Locking Fuel Cap .....	10502	
2007-2006: OE Type Radiator Cap .....	10238	16	2000-1999: Flex Fuel Regular Locking Fuel Cap .....	10502Y	
2007-2006: OE Equivalent Fuel Cap .....	10840		2000-1999: Oil Filler Cap .....	10081	
2007-2006: Regular Locking Fuel Cap .....	10510		1998-1995: Lev-R-Vent Radiator Cap .....	✓10333	16
2007-2006: Oil Filler Cap .....	10144		1998-1995: OE Type Radiator Cap .....	10233	16
2005: OE Type Radiator Cap .....	10238	16	1998-1995: Pre-Vent Non-Locking Fuel Cap .....	10819	
2005: OE Equivalent Fuel Cap .....	10840		1998-1995: Pre-Vent Locking Fuel Cap .....	10501	
2005: Regular Locking Fuel Cap .....	10510		1998-1995: Oil Filler Cap .....	10081	
2004: OE Type Radiator Cap .....	10238	16	<b>V-6 4.0 L</b>		
2004: OE Equivalent Fuel Cap .....	10840		2011-2010: Lev-R-Vent Radiator Cap .....	10333	16
2004: Regular Locking Fuel Cap .....	10510		2011-2010: OE Type Radiator Cap .....	10233	16
2004: Oil Filler Cap .....	10144		2011-2010: OE Equivalent Fuel Cap .....	10838	
2003: OE Type Radiator Cap .....	10238	16	2011-2010: Regular Locking Fuel Cap .....	10508	
2003: OE Equivalent Fuel Cap .....	10832		2011-2010: Oil Filler Cap .....	10117	
2003: Regular Locking Fuel Cap .....	10502		2009-2007: Lev-R-Vent Radiator Cap .....	10333	16
2003: Oil Filler Cap .....	10081		2009-2007: OE Type Radiator Cap .....	10233	16
2002: OE Type Radiator Cap .....	10238	16	2009-2007: OE Equivalent Fuel Cap .....	10840	
2002: OE Equivalent Fuel Cap .....	10832		2009-2007: Regular Locking Fuel Cap .....	10510	
2002: Regular Locking Fuel Cap .....	10502		2009-2007: Oil Filler Cap .....	10117	
2002: Oil Filler Cap .....	10117		2006-2004: Lev-R-Vent Radiator Cap .....	✓10333	16
2001: Lev-R-Vent Radiator Cap: Early .....	✓10333	16	2006-2004: OE Type Radiator Cap .....	10840	
2001: OE Type Radiator Cap: Early .....	10233	16	2006-2004: OE Equivalent Fuel Cap .....	10840	
2001: OE Type Radiator Cap: Late .....	10238	16	2006-2004: Regular Locking Fuel Cap .....	10510	
2001: OE Equivalent Fuel Cap .....	10832		2006-2004: Oil Filler Cap .....	10117	
2001: Regular Locking Fuel Cap .....	10502		2003-2001: Lev-R-Vent Radiator Cap .....	✓10333	16
2001: Oil Filler Cap .....	10117		2003-2001: OE Type Radiator Cap .....	10233	16
1997-1995: Lev-R-Vent Radiator Cap .....	10329	13	2003-2001: OE Equivalent Fuel Cap .....	10832	
1997-1995: OE Type Radiator Cap .....	10229	13	2003-2001: Regular Locking Fuel Cap .....	10502	
1997-1995: Pre-Vent Non-Locking Fuel Cap .....	10819		2003-2001: Oil Filler Cap .....	10117	
1997-1995: Pre-Vent Locking Fuel Cap .....	10501		2000-1999: Lev-R-Vent Radiator Cap .....	✓10333	16
1997-1995: Oil Filler Cap .....	10081		2000-1999: OE Type Radiator Cap .....	10233	16
<b>4-Cyl. 2.5 L</b>			2000-1999: OE Equivalent Fuel Cap .....	10832	
2001-1999: Lev-R-Vent Radiator Cap .....	✓10333	16	2000-1999: Regular Locking Fuel Cap .....	10502	
2001-1999: OE Type Radiator Cap .....	10233	16	2000-1999: Oil Filler Cap .....	10081	
2001-1999: OE Equivalent Fuel Cap .....	10832		1998-1995: Lev-R-Vent Radiator Cap .....	✓10333	16
2001-1999: Regular Locking Fuel Cap .....	10502		1998-1995: OE Type Radiator Cap .....	10233	16
2001-1999: Oil Filler Cap .....	10081		1998-1995: Pre-Vent Non-Locking Fuel Cap .....	10819	
1998: Lev-R-Vent Radiator Cap .....	✓10333	16	1998-1995: Pre-Vent Locking Fuel Cap .....	10501	
1998: OE Type Radiator Cap .....	10233	16	1998-1995: Oil Filler Cap .....	10081	
1998: Pre-Vent Non-Locking Fuel Cap .....	10819		<b>Sable</b>		
1998: Pre-Vent Locking Fuel Cap .....	10501		<b>V-6 3.0 L (Non-US)</b>		
1998: Oil Filler Cap .....	10081		1999: OE Type Radiator Cap .....	10238	16
<b>V-6 3.0 L</b>			1999: OE Equivalent Fuel Cap .....	10832	
2008-2007: Lev-R-Vent Radiator Cap .....	10333	16	1999: Flex Fuel Regular Fuel Cap .....	10832Y	
2008-2007: OE Type Radiator Cap .....	10233	16	1999: Regular Locking Fuel Cap .....	10502	
2008-2007: OE Equivalent Fuel Cap .....	10840		1999: Flex Fuel Regular Locking Fuel Cap .....	10502Y	
2008-2007: Regular Locking Fuel Cap .....	10510		1999: Oil Filler Cap .....	10081	
2008-2007: Oil Filler Cap .....	10117		<b>Super Duty Pickup</b>		
2006-2005: Lev-R-Vent Radiator Cap .....	✓10333	16	<b>V-10 6.8 L</b>		
2006-2005: OE Type Radiator Cap .....	10233	16	2010: OE Type Radiator Cap .....	10238	16
2006-2005: OE Equivalent Fuel Cap .....	10840		2010: OE Equivalent Fuel Cap .....	10840	

✓ Check Hood Clearance prior to installing this Cap.

## Caps for Passenger Cars and Light Trucks (1990 and Newer)

Application	Part Number	PSI	Application	Part Number	PSI
<b>Ford - Continued</b>			<b>Ford - Continued</b>		
<b>Super Duty Pickup - Continued</b>			<b>Super Duty Pickup - Continued</b>		
<b>V-10 6.8 L - Continued</b>			<b>V-8 5.4 L - Continued</b>		
2010; Regular Locking Fuel Cap .....	10510		1999; Oil Filler Cap .....	10081	
2010; Oil Filler Cap .....	10117		<b>V-8 6.0 L Diesel</b>		
2009; OE Type Radiator Cap .....	10267	20	2007-2006; OE Type Radiator Cap .....	10238	16
2009; Coolant Recovery Tank Cap .....	10238		2007-2006; OE Equivalent Fuel Cap .....	10817	
2009; OE Equivalent Fuel Cap .....	10840		2007-2006; Diesel Regular Non-Locking Fuel Cap .....	10830D	
2009; Regular Locking Fuel Cap .....	10510		2007-2006; Regular Locking Fuel Cap .....	10591	
2009; Oil Filler Cap .....	10117		2007-2006; Diesel Regular Locking Fuel Cap .....	10591D	
2008; OE Type Radiator Cap .....	10238	16	2007-2006; Pre-Vent Non-Locking Fuel Cap .....	10819	
2008; OE Equivalent Fuel Cap .....	10840		2007-2006; Diesel Pre-Vent Non-Locking Fuel Cap .....	10819D	
2008; Regular Locking Fuel Cap .....	10510		2007-2006; Pre-Vent Locking Fuel Cap .....	10501	
2008; Oil Filler Cap; W/O Threaded Filler Neck .....	10117		2007-2006; Diesel Only Pre-Vent Locking Fuel Cap .....	10501D	
2008; Oil Filler Cap; W/Threaded Filler Neck .....	10081		2007-2006; Oil Filler Cap .....	10081	
2007-2005; OE Type Radiator Cap .....	10238	16	2005-2003; OE Type Radiator Cap .....	10238	16
2007-2005; OE Equivalent Fuel Cap .....	10840		2005-2003; OE Equivalent Fuel Cap; W/Threaded Filler Neck ...	10817	
2007-2005; Regular Locking Fuel Cap .....	10510		2005-2003; Diesel Regular Non-Locking Fuel Cap; W/Threaded		
2007-2005; Oil Filler Cap .....	10117		Filler Neck .....	10830D	
2004-2002; OE Type Radiator Cap .....	10238	16	2005-2003; Regular Locking Fuel Cap; W/Threaded Filler Neck .	10591	
2004-2002; Pre-Vent Non-Locking Fuel Cap; W/Threaded Filler			2005-2003; Diesel Regular Locking Fuel Cap; W/Threaded Filler		
Neck .....	10819		Neck .....	10591D	
2004-2002; Pre-Vent Locking Fuel Cap; W/Threaded Filler Neck	10501		2005-2003; Pre-Vent Non-Locking Fuel Cap; W/Threaded Filler		
2004-2002; OE Equivalent Fuel Cap; W/O Threaded Filler Neck .	10832		Neck .....	10819	
2004-2002; Regular Locking Fuel Cap; W/O Threaded Filler			2005-2003; Diesel Pre-Vent Non-Locking Fuel Cap; W/Threaded		
Neck .....	10502		Filler Neck .....	10819D	
2004-2002; Oil Filler Cap .....	10081	16	2005-2003; Pre-Vent Locking Fuel Cap; W/Threaded Filler Neck	10501	
2001-2000; OE Type Radiator Cap .....	10238		2005-2003; Diesel Only Pre-Vent Locking Fuel Cap; W/Threaded		
2001-2000; OE Equivalent Fuel Cap; W/O Threaded Filler Neck .	10832		Filler Neck .....	10501D	
2001-2000; Regular Locking Fuel Cap; W/O Threaded Filler			2005-2003; OE Equivalent Fuel Cap; W/O Threaded Filler Neck .	10832	
Neck .....	10502		2005-2003; Diesel Regular Non-Locking Fuel Cap; W/O		
2001-2000; Pre-Vent Non-Locking Fuel Cap; W/Threaded Filler			Threaded Filler Neck .....	10832D	
Neck .....	10819		2005-2003; Regular Locking Fuel Cap; W/O Threaded Filler		
2001-2000; Pre-Vent Locking Fuel Cap; W/Threaded Filler Neck	10501		Neck .....	10502	
2001-2000; Oil Filler Cap .....	10081	16	2005-2003; Diesel Regular Locking Fuel Cap; W/O Threaded		
1999; OE Type Radiator Cap .....	10238		Filler Neck .....	10502D	
1999; Pre-Vent Non-Locking Fuel Cap; W/Threaded Filler Neck .	10819		2005-2003; Oil Filler Cap .....	10081	
1999; Pre-Vent Locking Fuel Cap; W/Threaded Filler Neck .....	10501		<b>V-8 6.2 L</b>		
1999; OE Equivalent Fuel Cap; W/O Threaded Filler Neck .....	10832		2012; OE Equivalent Fuel Cap .....	10840	
1999; Regular Locking Fuel Cap; W/O Threaded Filler Neck .....	10502		2012; Flex Fuel Regular Fuel Cap .....	10840Y	
1999; Oil Filler Cap .....	10081		2012; Regular Locking Fuel Cap .....	10510	
<b>V-8 5.4 L</b>			2012; Flex Fuel Regular Locking Fuel Cap .....	10510Y	
2010; OE Type Radiator Cap .....	10238	16	2011; OE Type Radiator Cap .....	10238	16
2010; OE Equivalent Fuel Cap .....	10840		2011; OE Equivalent Fuel Cap .....	10840	
2010; Regular Locking Fuel Cap .....	10510		2011; Flex Fuel Regular Fuel Cap .....	10840Y	
2010; Oil Filler Cap .....	10117		2011; Regular Locking Fuel Cap .....	10510	
2009; OE Type Radiator Cap .....	10267	20	2011; Flex Fuel Regular Locking Fuel Cap .....	10510Y	
2009; Coolant Recovery Tank Cap .....	10238		2011; Oil Filler Cap .....	10117	
2009; OE Equivalent Fuel Cap .....	10840		<b>V-8 6.4 L Diesel</b>		
2009; Regular Locking Fuel Cap .....	10510		2010-2009; OE Type Radiator Cap .....	10267	20
2009; Oil Filler Cap .....	10117		2010-2009; Coolant Recovery Tank Cap .....	10238	
2008-2005; OE Type Radiator Cap .....	10238	16	2010-2009; OE Equivalent Fuel Cap .....	10840	
2008-2005; OE Equivalent Fuel Cap .....	10840		2010-2009; Diesel Regular Non-Locking Fuel Cap .....	10840D	
2008-2005; Regular Locking Fuel Cap .....	10510		2010-2009; Regular Locking Fuel Cap .....	10510	
2008-2005; Oil Filler Cap .....	10117		2010-2009; Diesel Regular Locking Fuel Cap .....	10510D	
2004-2002; OE Type Radiator Cap .....	10238	16	2010-2009; Oil Filler Cap .....	10081	
2004-2002; Pre-Vent Non-Locking Fuel Cap; W/Threaded Filler			2008; OE Type Radiator Cap .....	10238	16
Neck .....	10819		2008; OE Equivalent Fuel Cap; W/Threaded Filler Neck .....	10817	
2004-2002; Pre-Vent Locking Fuel Cap; W/Threaded Filler Neck	10501		2008; Diesel Regular Non-Locking Fuel Cap; W/Threaded Filler		
2004-2002; OE Equivalent Fuel Cap; W/O Threaded Filler Neck .	10832		Neck .....	10830D	
2004-2002; Regular Locking Fuel Cap; W/O Threaded Filler			2008; Regular Locking Fuel Cap; W/Threaded Filler Neck .....	10591	
Neck .....	10502		2008; Diesel Regular Locking Fuel Cap; W/Threaded Filler Neck		
2004-2002; Oil Filler Cap .....	10081		2008; Pre-Vent Non-Locking Fuel Cap; W/Threaded Filler Neck .	10819	
2001-2000; OE Type Radiator Cap .....	10238	16	2008; Diesel Pre-Vent Non-Locking Fuel Cap; W/Threaded Filler		
2001-2000; OE Equivalent Fuel Cap; W/O Threaded Filler Neck .	10832		Neck .....	10819D	
2001-2000; Regular Locking Fuel Cap; W/O Threaded Filler			2008; Pre-Vent Locking Fuel Cap; W/Threaded Filler Neck .....	10501	
Neck .....	10502		2008; Diesel Only Pre-Vent Locking Fuel Cap; W/Threaded Filler		
2001-2000; Pre-Vent Non-Locking Fuel Cap; W/Threaded Filler			Neck .....	10501D	
Neck .....	10819		2008; OE Equivalent Fuel Cap; W/O Threaded Filler Neck .....	10840	
2001-2000; Pre-Vent Locking Fuel Cap; W/Threaded Filler Neck	10501		2008; Diesel Regular Non-Locking Fuel Cap; W/O Threaded		
2001-2000; Oil Filler Cap .....	10081	16	Filler Neck .....	10840D	
1999; OE Type Radiator Cap .....	10238		2008; Regular Locking Fuel Cap; W/O Threaded Filler Neck .....	10510	
1999; Pre-Vent Non-Locking Fuel Cap; W/Threaded Filler Neck .	10819		2008; Diesel Regular Locking Fuel Cap; W/O Threaded Filler		
1999; Pre-Vent Locking Fuel Cap; W/Threaded Filler Neck .....	10501		Neck .....	10510D	
1999; OE Equivalent Fuel Cap; W/O Threaded Filler Neck .....	10832		2008; Oil Filler Cap .....	10081	
1999; Regular Locking Fuel Cap; W/O Threaded Filler Neck .....	10502				

## Caps for Passenger Cars and Light Trucks (1990 and Newer)

Application	Part Number	PSI	Application	Part Number	PSI
<b>Ford - Continued</b>			<b>Ford - Continued</b>		
<b>Super Duty Pickup - Continued</b>			<b>Super Duty Van - Continued</b>		
<b>V-8 6.7 L Diesel</b>			<b>V-10 6.8 L - Continued</b>		
2012; OE Equivalent Fuel Cap .....	10840		2006-2004; OE Equivalent Fuel Cap .....	10840	
2012; Diesel Regular Non-Locking Fuel Cap .....	10840D		2006-2004; Regular Locking Fuel Cap .....	10510	
2012; Regular Locking Fuel Cap .....	10510		2006-2004; Oil Filler Cap .....	10117	
2012; Diesel Regular Locking Fuel Cap .....	10510D		2003-2002; OE Type Radiator Cap .....	10238	16
2011; Coolant Recovery Tank Cap .....	10238		2003-2002; OE Equivalent Fuel Cap; W/O Stripped Chassis .....	10832	
2011; OE Type Radiator Cap - Intercooler .....	10268	5	2003-2002; Regular Locking Fuel Cap; W/O Stripped Chassis ...	10502	
2011; OE Equivalent Fuel Cap .....	10840		2003-2002; Oil Filler Cap .....	10081	
2011; Diesel Regular Non-Locking Fuel Cap .....	10840D		2001; OE Type Radiator Cap .....	10238	16
2011; Regular Locking Fuel Cap .....	10510		2001; OE Equivalent Fuel Cap; W/O Threaded Fuel Cap .....	10832	
2011; Diesel Regular Locking Fuel Cap .....	10510D		2001; Regular Locking Fuel Cap; W/O Threaded Fuel Cap .....	10502	
2011; Oil Filler Cap .....	10117		2001; OE Equivalent Fuel Cap; W/Threaded Fuel Cap .....	10833	
<b>V-8 7.3 L Diesel</b>			2001; Regular Locking Fuel Cap; W/Threaded Fuel Cap .....	10503	
2003-1999; OE Type Radiator Cap .....	10238	16	2001; Oil Filler Cap .....	10081	
2003-1999; OE Equivalent Fuel Cap; W/Threaded Filler Neck ...	10817		2000; OE Type Radiator Cap .....	10238	16
2003-1999; Diesel Regular Non-Locking Fuel Cap; W/Threaded Filler Neck .....	10830D		2000; Pre-Vent Non-Locking Fuel Cap .....	10819	
2003-1999; Regular Locking Fuel Cap; W/Threaded Filler Neck .	10591		2000; Pre-Vent Locking Fuel Cap .....	10501	
2003-1999; Diesel Regular Locking Fuel Cap; W/Threaded Filler Neck .....	10591D		2000; Oil Filler Cap .....	10081	
2003-1999; Pre-Vent Non-Locking Fuel Cap; W/Threaded Filler Neck .....	10819		1999; OE Type Radiator Cap .....	10238	16
2003-1999; Diesel Pre-Vent Non-Locking Fuel Cap; W/Threaded Filler Neck .....	10819D		1999; OE Equivalent Fuel Cap .....	10832	
2003-1999; Pre-Vent Locking Fuel Cap; W/Threaded Filler Neck	10501		1999; Regular Locking Fuel Cap .....	10502	
2003-1999; Diesel Only Pre-Vent Locking Fuel Cap; W/Threaded Filler Neck .....	10501D		1999; Oil Filler Cap .....	10081	
2003-1999; OE Equivalent Fuel Cap; W/O Threaded Filler Neck .	10832		1998; OE Type Radiator Cap .....	10238	16
2003-1999; Diesel Regular Non-Locking Fuel Cap; W/O Threaded Filler Neck .....	10832D		1998; OE Equivalent Fuel Cap; W/O Threaded Filler Neck .....	10832	
2003-1999; Regular Locking Fuel Cap; W/O Threaded Filler Neck .....	10502		1998; Regular Locking Fuel Cap; W/O Threaded Filler Neck .....	10502	
2003-1999; Diesel Regular Locking Fuel Cap; W/O Threaded Filler Neck .....	10502D		1998; Pre-Vent Non-Locking Fuel Cap; W/Threaded Filler Neck .	10819	
2003-1999; Oil Filler Cap .....	10081		1998; Pre-Vent Locking Fuel Cap; W/Threaded Filler Neck .....	10501	
1997-1995; OE Type Radiator Cap .....	10238	16	1998; Oil Filler Cap .....	10081	
1997-1995; OE Equivalent Fuel Cap .....	10817		1997; Lev-R-Vent Radiator Cap .....	10329	13
1997-1995; Diesel Regular Non-Locking Fuel Cap .....	10830D		1997; OE Type Radiator Cap .....	10229	13
1997-1995; Regular Locking Fuel Cap .....	10591		1997; OE Equivalent Fuel Cap .....	10832	
1997-1995; Diesel Regular Locking Fuel Cap .....	10591D		1997; Regular Locking Fuel Cap .....	10502	
1997-1995; Pre-Vent Non-Locking Fuel Cap .....	10819		1997; Oil Filler Cap .....	10081	
1997-1995; Diesel Pre-Vent Non-Locking Fuel Cap .....	10819D		<b>V-6 4.2 L</b>		
1997-1995; Pre-Vent Locking Fuel Cap .....	10501		2003; OE Type Radiator Cap .....	10238	16
1997-1995; Diesel Only Pre-Vent Locking Fuel Cap .....	10501D		2003; OE Equivalent Fuel Cap; W/O Stripped Chassis .....	10832	
1997-1995; Oil Filler Cap .....	10081		2003; Regular Locking Fuel Cap; W/O Stripped Chassis .....	10502	
<b>V-8 7.5 L</b>			2003; Oil Filler Cap .....	10081	
1997-1995; Lev-R-Vent Radiator Cap .....	10329	13	2002; OE Type Radiator Cap .....	10238	16
1997-1995; OE Type Radiator Cap .....	10229	13	2002; OE Equivalent Fuel Cap; W/O Stripped Chassis .....	10832	
1997-1995; Pre-Vent Non-Locking Fuel Cap .....	10819		2002; Regular Locking Fuel Cap; W/O Stripped Chassis .....	10502	
1997-1995; Pre-Vent Locking Fuel Cap .....	10501		2001; OE Type Radiator Cap .....	10238	16
1997-1995; Oil Filler Cap; W/Oil Filler Tube .....	10081		2001; OE Equivalent Fuel Cap .....	10832	
1997-1995; Oil Breather Cap; W/O Oil Filler Tube .....	10071		2001; Regular Locking Fuel Cap .....	10502	
<b>Super Duty Van</b>			<b>V-8 4.6 L</b>		
<b>6-Cyl. 4.9 L</b>			2009; OE Type Radiator Cap .....	10238	16
1996; OE Type Radiator Cap .....	10238	16	2009; OE Equivalent Fuel Cap .....	10840	
<b>V-10 6.8 L</b>			2009; Regular Locking Fuel Cap .....	10510	
2012; OE Equivalent Fuel Cap .....	10840		2008; OE Equivalent Fuel Cap .....	10840	
2012; Regular Locking Fuel Cap .....	10510		2008; Regular Locking Fuel Cap .....	10510	
2011-2009; OE Type Radiator Cap .....	10238	16	2008; Oil Filler Cap .....	10117	
2011-2009; OE Equivalent Fuel Cap .....	10840		2006; OE Type Radiator Cap .....	10238	16
2011-2009; Regular Locking Fuel Cap .....	10510		2006; OE Equivalent Fuel Cap .....	10840	
2011-2009; Oil Filler Cap .....	10117		2006; Regular Locking Fuel Cap .....	10510	
2008; OE Type Radiator Cap .....	10238	16	2004; OE Type Radiator Cap .....	10238	16
2008; OE Equivalent Fuel Cap .....	10840		2004; OE Equivalent Fuel Cap .....	10840	
2008; Regular Locking Fuel Cap .....	10510		2004; Regular Locking Fuel Cap .....	10510	
2008; Oil Filler Cap; W/Threaded Filler Neck .....	10081		2004; Regular Locking Fuel Cap .....	10510	
2008; Oil Filler Cap; W/O Threaded Filler Neck .....	10117		2003; OE Type Radiator Cap .....	10238	16
2007; OE Type Radiator Cap .....	10238	16	2003; OE Equivalent Fuel Cap; W/O Stripped Chassis .....	10832	
2007; OE Equivalent Fuel Cap .....	10840		2003; Regular Locking Fuel Cap; W/O Stripped Chassis .....	10502	
2007; Regular Locking Fuel Cap .....	10510		2003; Oil Filler Cap .....	10081	
2007; Oil Filler Cap .....	10081		<b>V-8 5.4 L</b>		
2006-2004; OE Type Radiator Cap .....	10238	16	2012; OE Equivalent Fuel Cap .....	10840	
			2012; Regular Locking Fuel Cap .....	10510	
			2012; Flex Fuel Regular Fuel Cap .....	10840Y	
			2012; Flex Fuel Regular Locking Fuel Cap .....	10510Y	
			2011-2009; OE Type Radiator Cap .....	10238	16
			2011-2009; OE Equivalent Fuel Cap .....	10840	
			2011-2009; Regular Locking Fuel Cap .....	10510	
			2011-2009; Flex Fuel Regular Fuel Cap .....	10840Y	
			2011-2009; Flex Fuel Regular Locking Fuel Cap .....	10510Y	
			2011-2009; Oil Filler Cap .....	10117	
			2008-2004; OE Type Radiator Cap .....	10238	16

## Caps for Passenger Cars and Light Trucks (1990 and Newer)

Application	Part Number	PSI	Application	Part Number	PSI
<b>Ford - Continued</b>			<b>Ford - Continued</b>		
<b>Super Duty Van - Continued</b>			<b>Super Duty Van - Continued</b>		
<b>V-8 5.4 L - Continued</b>			<b>V-8 7.3 L Diesel - Continued</b>		
2008-2004; OE Equivalent Fuel Cap .....	10840		2001-2000; Regular Locking Fuel Cap; W/Threaded Filler Neck .	10591	
2008-2004; Regular Locking Fuel Cap .....	10510		2001-2000; Diesel Regular Locking Fuel Cap; W/Threaded Filler Neck .....	10591D	
2008-2004; Oil Filler Cap .....	10117		2001-2000; Pre-Vent Non-Locking Fuel Cap; W/Threaded Filler Neck .....	10819	
2003-2002; OE Type Radiator Cap .....	10238	16	2001-2000; Diesel Pre-Vent Non-Locking Fuel Cap; W/Threaded Filler Neck .....	10819D	
2003-2002; OE Equivalent Fuel Cap; W/O Stripped Chassis .....	10832		2001-2000; Pre-Vent Locking Fuel Cap; W/Threaded Filler Neck	10501	
2003-2002; Regular Locking Fuel Cap; W/O Stripped Chassis ...	10502		2001-2000; Diesel Only Pre-Vent Locking Fuel Cap; W/Threaded Filler Neck .....	10501D	
2003-2002; Oil Filler Cap .....	10081		2001-2000; OE Equivalent Fuel Cap; W/O Threaded Filler Neck .	10832	
2001; OE Type Radiator Cap .....	10238	16	2001-2000; Diesel Regular Non-Locking Fuel Cap; W/O Threaded Filler Neck .....	10832D	
2001; OE Equivalent Fuel Cap .....	10832		2001-2000; Regular Locking Fuel Cap; W/O Threaded Filler Neck .....	10502	
2001; Regular Locking Fuel Cap .....	10502		2001-2000; Diesel Regular Locking Fuel Cap; W/O Threaded Filler Neck .....	10502D	
2001; Oil Filler Cap .....	10081		2001-2000; Oil Filler Cap .....	10081	
2000; OE Type Radiator Cap .....	10238	16	1999-1998; OE Type Radiator Cap .....	10238	16
2000; OE Equivalent Fuel Cap; W/O Threaded Filler Neck .....	10832		1999-1998; OE Equivalent Fuel Cap; W/O Threaded Filler Neck .	10832	
2000; Regular Locking Fuel Cap; W/O Threaded Filler Neck .....	10502		1999-1998; Regular Locking Fuel Cap; W/O Threaded Filler Neck .....	10502	
2000; Pre-Vent Non-Locking Fuel Cap; W/Threaded Filler Neck .	10819		1999-1998; Diesel Regular Non-Locking Fuel Cap; W/O Threaded Filler Neck .....	10832D	
2000; Pre-Vent Locking Fuel Cap; W/Threaded Filler Neck .....	10501		1999-1998; Diesel Regular Locking Fuel Cap; W/O Threaded Filler Neck .....	10502D	
2000; Oil Filler Cap .....	10081		1999-1998; Pre-Vent Non-Locking Fuel Cap; W/Threaded Filler Neck .....	10819	
1999-1997; OE Type Radiator Cap .....	10238	16	1999-1998; Pre-Vent Locking Fuel Cap; W/Threaded Filler Neck	10501	
1999-1997; OE Equivalent Fuel Cap .....	10832		1999-1998; Diesel Pre-Vent Non-Locking Fuel Cap; W/Threaded Filler Neck .....	10819D	
1999-1997; Regular Locking Fuel Cap .....	10502		1999-1998; Diesel Only Pre-Vent Locking Fuel Cap; W/Threaded Filler Neck .....	10501D	
1999-1997; Oil Filler Cap .....	10081		1999-1998; Oil Filler Cap .....	10081	
<b>V-8 5.8 L</b>			1997; OE Type Radiator Cap .....	10238	16
1996; Lev-R-Vent Radiator Cap .....	10329	13	1997; OE Equivalent Fuel Cap .....	10832	
1996; OE Type Radiator Cap .....	10229	13	1997; Diesel Regular Non-Locking Fuel Cap .....	10832D	
<b>V-8 6.0 L Diesel</b>			1997; Regular Locking Fuel Cap .....	10502	
2010; OE Type Radiator Cap .....	10238	16	1997; Diesel Regular Locking Fuel Cap .....	10502D	
2010; OE Equivalent Fuel Cap .....	10840		1997; Pre-Vent Non-Locking Fuel Cap .....	10819	
2010; Regular Locking Fuel Cap .....	10510		1997; Diesel Pre-Vent Non-Locking Fuel Cap .....	10819D	
2010; Oil Filler Cap .....	10117		1997; Pre-Vent Locking Fuel Cap .....	10501	
2009-2008; OE Type Radiator Cap .....	10238	16	1997; Diesel Only Pre-Vent Locking Fuel Cap .....	10501D	
2009-2008; OE Equivalent Fuel Cap .....	10840		1997; Oil Filler Cap .....	10081	
2009-2008; Diesel Regular Non-Locking Fuel Cap .....	10840D		1996; OE Type Radiator Cap .....	10238	16
2009-2008; Regular Locking Fuel Cap .....	10510		1996; Pre-Vent Non-Locking Fuel Cap .....	10819	
2009-2008; Diesel Regular Locking Fuel Cap .....	10510D		1996; Diesel Pre-Vent Non-Locking Fuel Cap .....	10819D	
2009-2008; Oil Filler Cap .....	10117		1996; Pre-Vent Locking Fuel Cap .....	10501	
2007-2004; OE Type Radiator Cap .....	10238	16	1996; Diesel Only Pre-Vent Locking Fuel Cap .....	10501D	
2007-2004; OE Equivalent Fuel Cap .....	10840		1997; Oil Filler Cap .....	10081	
2007-2004; Diesel Regular Non-Locking Fuel Cap .....	10840D		1996; OE Type Radiator Cap .....	10238	16
2007-2004; Regular Locking Fuel Cap .....	10510		1996; Pre-Vent Non-Locking Fuel Cap .....	10819	
2007-2004; Diesel Regular Locking Fuel Cap .....	10510D		1996; Diesel Pre-Vent Non-Locking Fuel Cap .....	10819D	
2007-2004; Oil Filler Cap .....	10081		1996; Pre-Vent Locking Fuel Cap .....	10501	
<b>V-8 7.3 L Diesel</b>			1996; Diesel Only Pre-Vent Locking Fuel Cap .....	10501D	
2003; OE Type Radiator Cap .....	10238	16	2003; Lev-R-Vent Radiator Cap .....	10329	13
2003; OE Equivalent Fuel Cap; W/Threaded Filler Neck .....	10817		2003; OE Type Radiator Cap .....	10229	13
2003; Diesel Regular Non-Locking Fuel Cap; W/Threaded Filler Neck .....	10830D		<b>Taurus</b>		
2003; Regular Locking Fuel Cap; W/Threaded Filler Neck .....	10591		<b>V-6 3.0 L</b>		
2003; Diesel Regular Locking Fuel Cap; W/Threaded Filler Neck	10591D		2007; OE Type Radiator Cap .....	10238	16
2003; Pre-Vent Non-Locking Fuel Cap; W/Threaded Filler Neck .	10819		2007; OE Equivalent Fuel Cap .....	10840	
2003; Diesel Pre-Vent Non-Locking Fuel Cap; W/Threaded Filler Neck .....	10819D		2007; Regular Locking Fuel Cap .....	10510	
2003; Pre-Vent Locking Fuel Cap; W/Threaded Filler Neck .....	10501		2007; Oil Filler Cap .....	10117	
2003; Diesel Only Pre-Vent Locking Fuel Cap; W/Threaded Filler Neck .....	10501D		2006; OE Type Radiator Cap .....	10238	16
2003; OE Equivalent Fuel Cap; W/O Threaded Filler Neck .....	10832		2006; OE Equivalent Fuel Cap .....	10840	
2003; Diesel Regular Non-Locking Fuel Cap; W/O Threaded Filler Neck .....	10832D		2006; Flex Fuel Regular Fuel Cap .....	10840Y	
2003; Regular Locking Fuel Cap; W/O Threaded Filler Neck .....	10502		2006; Regular Locking Fuel Cap .....	10510	
2003; Diesel Regular Locking Fuel Cap; W/O Threaded Filler Neck .....	10502D		2006; Flex Fuel Regular Locking Fuel Cap .....	10510Y	
2003; Oil Filler Cap .....	10081		2006; Oil Filler Cap .....	10117	
2002; OE Type Radiator Cap .....	10238	16	2005-2004; OE Type Radiator Cap .....	10238	16
2002; OE Equivalent Fuel Cap; W/O Stripped Chassis .....	10832		2005-2004; OE Equivalent Fuel Cap; For Black Bottom O.E. Cap	10832	
2002; Regular Locking Fuel Cap; W/O Stripped Chassis .....	10502		2005-2004; Flex Fuel Regular Fuel Cap; For Black Bottom O.E. Cap .....	10832Y	
2002; Diesel Regular Non-Locking Fuel Cap; W/O Stripped Chassis .....	10832D		2005-2004; Regular Locking Fuel Cap; For Black Bottom O.E. Cap .....	10502	
2002; Diesel Regular Locking Fuel Cap; W/O Stripped Chassis .	10502D		2005-2004; Flex Fuel Regular Locking Fuel Cap; For Black Bottom O.E. Cap .....	10502Y	
2002; Oil Filler Cap .....	10081				
2001-2000; OE Type Radiator Cap .....	10238	16			
2001-2000; OE Equivalent Fuel Cap; W/Threaded Filler Neck ...	10817				
2001-2000; Diesel Regular Non-Locking Fuel Cap; W/Threaded Filler Neck .....	10830D				



## Caps for Passenger Cars and Light Trucks (1990 and Newer)

Application	Part Number	PSI	Application	Part Number	PSI
<b>Ford - Continued</b>			<b>Ford - Continued</b>		
<b>Taurus - Continued</b>			<b>Thunderbird - Continued</b>		
<b>V-6 3.0 L - Continued</b>			<b>V-6 3.8 L - Continued</b>		
2005-2004: OE Equivalent Fuel Cap; For White Bottom O.E. Cap W/Orange O-Ring Seal .....	10840		1997-1995: Pre-Vent Non-Locking Fuel Cap .....	10819	
2005-2004: Flex Fuel Regular Fuel Cap; For White Bottom O.E. Cap W/Orange O-Ring Seal .....	10840Y		1997-1995: Pre-Vent Locking Fuel Cap .....	10501	
2005-2004: Regular Locking Fuel Cap; For White Bottom O.E. Cap W/Orange O-Ring Seal .....	10510		1997-1995: Oil Filler Cap .....	10081	
2005-2004: Flex Fuel Regular Locking Fuel Cap; For White Bottom O.E. Cap W/Orange O-Ring Seal .....	10510Y		<b>V-8 3.9 L</b>		
2005-2004: Oil Filler Cap .....	10117		2005-2002: OE Type Radiator Cap .....	10238	16
2003-2001: OE Type Radiator Cap .....	10238	16	2005-2002: OE Equivalent Fuel Cap .....	10832	
2003-2001: OE Equivalent Fuel Cap .....	10832		2005-2002: Regular Locking Fuel Cap .....	10502	
2003-2001: Flex Fuel Regular Fuel Cap .....	10832Y		2005-2002: Oil Filler Cap .....	10101	
2003-2001: Regular Locking Fuel Cap .....	10502		<b>V-8 4.6 L</b>		
2003-2001: Flex Fuel Regular Locking Fuel Cap .....	10502Y		1997-1995: OE Type Radiator Cap .....	10238	16
2003-2001: Oil Filler Cap .....	10117		1997-1995: Pre-Vent Non-Locking Fuel Cap .....	10819	
2000: OE Type Radiator Cap .....	10238	16	1997-1995: Pre-Vent Locking Fuel Cap .....	10501	
2000: OE Equivalent Fuel Cap .....	10832		1997-1995: Oil Filler Cap .....	10081	
2000: Flex Fuel Regular Fuel Cap .....	10832Y		<b>Transit Connect</b>		
2000: Regular Locking Fuel Cap .....	10502		<b>4-Cyl. 2.0 L</b>		
2000: Flex Fuel Regular Locking Fuel Cap .....	10502Y		2012-2010: OE Equivalent Fuel Cap .....	10851	
2000: Oil Filler Cap; Eng. VIN U .....	10081		2012-2010: Regular Locking Fuel Cap .....	10521	
2000: Oil Filler Cap; Eng. VIN S .....	10117		<b>Windstar</b>		
1999-1996: OE Type Radiator Cap .....	10238	16	<b>V-6 3.0 L</b>		
1999-1996: OE Equivalent Fuel Cap .....	10832		2000: Lev-R-Vent Radiator Cap .....	✓10333	16
1999-1996: Flex Fuel Regular Fuel Cap .....	10832Y		2000: OE Type Radiator Cap .....	10238	16
1999-1996: Regular Locking Fuel Cap .....	10502		2000: OE Equivalent Fuel Cap .....	10832	
1999-1996: Flex Fuel Regular Locking Fuel Cap .....	10502Y		2000: Regular Locking Fuel Cap .....	10502	
1999-1996: Oil Filler Cap .....	10081		2000: Oil Filler Cap .....	10081	
1995: Lev-R-Vent Radiator Cap .....	10330	16	1999-1998: Lev-R-Vent Radiator Cap .....	✓10333	16
1995: OE Type Radiator Cap .....	10230	16	1999-1998: OE Type Radiator Cap .....	10233	16
1995: Pre-Vent Non-Locking Fuel Cap .....	10819		1999-1998: OE Equivalent Fuel Cap .....	10832	
1995: Pre-Vent Locking Fuel Cap .....	10501		1999-1998: Regular Locking Fuel Cap .....	10502	
1995: Oil Filler Cap .....	10081		1999-1998: Oil Filler Cap .....	10081	
<b>V-6 3.2 L</b>			1997-1995: Lev-R-Vent Radiator Cap .....	✓10333	16
1995: Lev-R-Vent Radiator Cap .....	10330	16	1997-1995: OE Type Radiator Cap .....	10233	16
1995: OE Type Radiator Cap .....	10230	16	1997-1995: Pre-Vent Non-Locking Fuel Cap .....	10819	
1995: Pre-Vent Non-Locking Fuel Cap .....	10819		1997-1995: Pre-Vent Locking Fuel Cap .....	10501	
1995: Pre-Vent Locking Fuel Cap .....	10501		1997-1995: Oil Filler Cap .....	10081	
1995: Oil Filler Cap .....	10081		<b>V-6 3.8 L</b>		
<b>V-6 3.5 L</b>			2003-2002: OE Type Radiator Cap .....	10238	16
2011-2010: OE Type Radiator Cap .....	10238	16	2003-2002: OE Equivalent Fuel Cap .....	10832	
2011-2010: Oil Filler Cap .....	10117		2003-2002: Regular Locking Fuel Cap .....	10502	
2009-2008: OE Type Radiator Cap .....	10238	16	2003-2002: Oil Filler Cap .....	10081	
2009-2008: OE Equivalent Fuel Cap .....	10840		2001: Lev-R-Vent Radiator Cap .....	✓10333	16
2009-2008: Regular Locking Fuel Cap .....	10510		2001: OE Type Radiator Cap .....	10233	16
2009-2008: Oil Filler Cap .....	10117		2001: Coolant Recovery Tank Cap .....	10236	
<b>V-6 3.8 L</b>			2001: OE Equivalent Fuel Cap .....	10832	
1995: Lev-R-Vent Radiator Cap .....	10330	16	2001: Regular Locking Fuel Cap .....	10502	
1995: OE Type Radiator Cap .....	10230	16	2001: Oil Filler Cap .....	10081	
1995: Pre-Vent Non-Locking Fuel Cap .....	10819		2000-1998: Lev-R-Vent Radiator Cap .....	✓10333	16
1995: Pre-Vent Locking Fuel Cap .....	10501		2000-1998: OE Type Radiator Cap .....	10233	16
1995: Oil Filler Cap .....	10081		2000-1998: OE Equivalent Fuel Cap .....	10832	
<b>V-8 3.4 L</b>			2000-1998: Regular Locking Fuel Cap .....	10502	
1999-1996: OE Type Radiator Cap .....	10238	16	2000-1998: Oil Filler Cap .....	10081	
1999-1996: OE Equivalent Fuel Cap .....	10832		1997-1995: Lev-R-Vent Radiator Cap .....	✓10333	16
1999-1996: Regular Locking Fuel Cap .....	10502		1997-1995: OE Type Radiator Cap .....	10233	16
1999-1996: Oil Filler Cap .....	10081		1997-1995: Pre-Vent Non-Locking Fuel Cap .....	10819	
<b>Taurus X</b>			1997-1995: Pre-Vent Locking Fuel Cap .....	10501	
<b>V-6 3.5 L</b>			1997-1995: Oil Filler Cap .....	10081	
2009: OE Type Radiator Cap .....	10238	16	<b>ZX2</b>		
2009: OE Equivalent Fuel Cap .....	10840		<b>4-Cyl. 2.0 L</b>		
2009: Regular Locking Fuel Cap .....	10510		2003: Lev-R-Vent Radiator Cap .....	✓10333	16
2009: Oil Filler Cap .....	10117		2003: OE Type Radiator Cap .....	10233	16
2008: OE Type Radiator Cap .....	10238	16	2003: OE Equivalent Fuel Cap .....	10832	
2008: OE Equivalent Fuel Cap .....	10840		2003: Regular Locking Fuel Cap .....	10502	
2008: Regular Locking Fuel Cap .....	10510		2003: Oil Filler Cap .....	10101	
<b>Thunderbird</b>			<b>Freightliner</b>		
<b>V-6 3.8 L</b>			<b>Sprinter</b>		
1997-1995: Lev-R-Vent Radiator Cap .....	✓10333	16	<b>5-Cyl. 2.7 L Diesel</b>		
1997-1995: OE Type Radiator Cap .....	10233	16	2006: OE Type Radiator Cap .....	10252	15
			2006: OE Equivalent Fuel Cap .....	10843	

✓ Check Hood Clearance prior to installing this Cap.

## Caps for Passenger Cars and Light Trucks (1990 and Newer)

Application	Part Number	PSI	Application	Part Number	PSI
<b>Freightliner - Continued</b>			<b>GMC - Continued</b>		
<b>Sprinter - Continued</b>			<b>C &amp; K Series Pickup - Continued</b>		
<b>5-Cyl. 2.7 L Diesel - Continued</b>			<b>V-6 4.3 L - Continued</b>		
2005-2003; Lev-R-Vent Radiator Cap .....	10334	18	1998; Regular Locking Fuel Cap .....	10504	
2005-2003; OE Type Radiator Cap .....	10234	18	1998; Oil Filler Cap .....	10099	
2005-2003; OE Equivalent Fuel Cap .....	10843		1997; Lev-R-Vent Radiator Cap .....	10331	16
<b>V-6 3.0 L Diesel</b>			1997; OE Type Radiator Cap .....	10231	16
2011-2010; OE Type Radiator Cap .....	10252	15	1997; OE Equivalent Fuel Cap; Wideside .....	10817	
2009-2008; OE Type Radiator Cap .....	10252	15	1997; Pre-Vent Non-Locking Fuel Cap; Wideside .....	10819	
2009-2008; Oil Filler Cap .....	10130		1997; Regular Locking Fuel Cap; Wideside .....	10591	
2007; OE Type Radiator Cap .....	10252	15	1997; Pre-Vent Locking Fuel Cap; Wideside .....	10501	
<b>V-6 3.5 L</b>			1997; OE Equivalent Fuel Cap; Sportside .....	10834	
2009; OE Type Radiator Cap .....	10252	15	1997; Regular Locking Fuel Cap; Sportside .....	10504	
2008; OE Type Radiator Cap .....	10252	15	1997; Oil Filler Cap .....	10099	
2008; Oil Filler Cap .....	10130		1996-1995; Lev-R-Vent Radiator Cap .....	10331	16
2007; OE Type Radiator Cap .....	10252	15	1996-1995; OE Type Radiator Cap .....	10231	16
<b>Geo</b>			1996-1995; OE Equivalent Fuel Cap .....	10817	
<b>Metro</b>			1996-1995; Pre-Vent Non-Locking Fuel Cap .....	10819	
<b>3-Cyl. 1.0 L</b>			1996-1995; Regular Locking Fuel Cap .....	10591	
1997-1995; OE Type Radiator Cap .....	10241	13	1996-1995; Pre-Vent Locking Fuel Cap .....	10501	
1997-1995; OE Equivalent Fuel Cap .....	10825		1996-1995; Oil Filler Cap .....	10099	
1997-1995; Regular Locking Fuel Cap .....	10595		<b>V-8 5.0 L</b>		
1997-1995; Oil Filler Cap .....	10101		1999-1998; Lev-R-Vent Radiator Cap .....	10331	16
<b>4-Cyl. 1.3 L</b>			1999-1998; OE Type Radiator Cap .....	10231	16
1997-1996; OE Type Radiator Cap .....	10241	13	1999-1998; OE Equivalent Fuel Cap .....	10834	
1997-1996; OE Equivalent Fuel Cap .....	10825		1999-1998; Regular Locking Fuel Cap .....	10504	
1997-1996; Regular Locking Fuel Cap .....	10595		1999-1998; Oil Filler Cap .....	10105	
1997-1996; Oil Filler Cap .....	10101		1997-1995; Lev-R-Vent Radiator Cap .....	10331	16
1995; OE Type Radiator Cap .....	10242	16	1997-1995; OE Type Radiator Cap .....	10231	16
1995; OE Equivalent Fuel Cap .....	10825		1997-1995; OE Equivalent Fuel Cap .....	10817	
1995; Regular Locking Fuel Cap .....	10595		1997-1995; Pre-Vent Non-Locking Fuel Cap .....	10819	
1995; Oil Filler Cap .....	10101		1997-1995; Regular Locking Fuel Cap .....	10591	
<b>Prizm</b>			1997-1995; Pre-Vent Locking Fuel Cap .....	10501	
<b>4-Cyl. 1.6 L; 4-Cyl. 1.8 L</b>			1997-1995; Oil Filler Cap .....	10105	
1997-1995; OE Type Radiator Cap .....	10241	13	<b>V-8 5.7 L</b>		
1997-1995; OE Equivalent Fuel Cap .....	10825		2000-1998; Lev-R-Vent Radiator Cap .....	10331	16
1997-1995; Regular Locking Fuel Cap .....	10595		2000-1998; OE Type Radiator Cap .....	10231	16
1997-1995; Oil Filler Cap .....	10080		2000-1998; OE Equivalent Fuel Cap .....	10834	
<b>Tracker</b>			2000-1998; Regular Locking Fuel Cap .....	10504	
<b>4-Cyl. 1.6 L</b>			2000-1998; Oil Filler Cap .....	10105	
1997; OE Type Radiator Cap .....	10242	16	1997-1995; Lev-R-Vent Radiator Cap .....	10331	16
1997; OE Equivalent Fuel Cap .....	10825		1997-1995; OE Type Radiator Cap .....	10231	16
1997; Regular Locking Fuel Cap .....	10595		1997-1995; OE Equivalent Fuel Cap .....	10817	
1997; Oil Filler Cap .....	10081		1997-1995; Pre-Vent Non-Locking Fuel Cap .....	10819	
1996; OE Type Radiator Cap .....	10242	16	1997-1995; Regular Locking Fuel Cap .....	10591	
1996; OE Equivalent Fuel Cap .....	10825		1997-1995; Pre-Vent Locking Fuel Cap .....	10501	
1996; Regular Locking Fuel Cap .....	10595		1997-1995; Oil Filler Cap .....	10105	
1996; Oil Filler Cap .....	10101		<b>V-8 6.5 L Diesel</b>		
1995; OE Type Radiator Cap .....	10242	16	2002; Lev-R-Vent Radiator Cap .....	10330	16
1995; OE Equivalent Fuel Cap .....	10825		2002; OE Type Radiator Cap .....	10230	16
1995; Regular Locking Fuel Cap .....	10595		2002; OE Equivalent Fuel Cap .....	10830	
1995; Oil Filler Cap .....	10101		2002; Diesel Regular Non-Locking Fuel Cap .....	10830D	
<b>GMC</b>			2002; Regular Locking Fuel Cap .....	10591	
<b>Acadia</b>			2002; Diesel Regular Locking Fuel Cap .....	10591D	
<b>V-6 3.6 L</b>			2002; Oil Filler Cap .....	10099	
2011; OE Type Radiator Cap .....	10248	15	2001; OE Type Radiator Cap .....	10248	15
2011; OE Equivalent Fuel Cap .....	10834		2001; OE Equivalent Fuel Cap .....	10830	
2011; Regular Locking Fuel Cap .....	10504		2001; Diesel Regular Non-Locking Fuel Cap .....	10830D	
2010-2007; OE Type Radiator Cap .....	10248	15	2001; Regular Locking Fuel Cap .....	10591	
2010-2007; OE Equivalent Fuel Cap .....	10841		2001; Diesel Regular Locking Fuel Cap .....	10591D	
2010-2007; Regular Locking Fuel Cap .....	10511		2001; Oil Filler Cap .....	10099	
2010-2007; Oil Filler Cap .....	10099		2000-1998; Lev-R-Vent Radiator Cap .....	10330	16
<b>C &amp; K Series Pickup</b>			2000-1998; OE Type Radiator Cap .....	10230	16
<b>V-6 4.3 L</b>			2000-1998; OE Equivalent Fuel Cap .....	10830	
1998; Lev-R-Vent Radiator Cap .....	10331	16	2000-1998; Diesel Regular Non-Locking Fuel Cap .....	10830D	
1998; OE Type Radiator Cap .....	10231	16	2000-1998; Regular Locking Fuel Cap .....	10591	
1998; OE Equivalent Fuel Cap .....	10834		2000-1998; Diesel Regular Locking Fuel Cap .....	10591D	
			2000-1998; Oil Filler Cap .....	10099	
			1997; Lev-R-Vent Radiator Cap .....	10330	16
			1997; OE Type Radiator Cap .....	10230	16
			1997; OE Equivalent Fuel Cap .....	10830	
			1997; Diesel Pre-Vent Non-Locking Fuel Cap .....	10819D	
			1997; Diesel Regular Non-Locking Fuel Cap .....	10830D	
			1997; Regular Locking Fuel Cap .....	10591	
			1997; Diesel Only Pre-Vent Locking Fuel Cap .....	10501D	

## Caps for Passenger Cars and Light Trucks (1990 and Newer)

Application	Part Number	PSI	Application	Part Number	PSI
<b>GMC - Continued</b>			<b>GMC - Continued</b>		
<b>C &amp; K Series Pickup - Continued</b>			<b>Canyon - Continued</b>		
<b>V-8 6.5 L Diesel - Continued</b>			<b>V-8 5.3 L</b>		
1997: Diesel Regular Locking Fuel Cap .....	10591D		2011-2009: OE Type Radiator Cap .....	10248	15
1997: Oil Filler Cap; W/Metal Oil Cap .....	10066		2011-2009: OE Equivalent Fuel Cap .....	10841	
1997: Oil Filler Cap; W/O Metal Oil Cap .....	10099		2011-2009: Regular Locking Fuel Cap .....	10511	
1996: Lev-R-Vent Radiator Cap .....	10330	16	2011-2009: Oil Filler Cap .....	10099	
1996: OE Type Radiator Cap .....	10230	16	<b>Envoy</b>		
1996: OE Equivalent Fuel Cap .....	10830		<b>6-Cyl. 4.2 L</b>		
1996: Diesel Pre-Vent Non-Locking Fuel Cap .....	10819D		2009-2005: OE Type Radiator Cap .....	10248	15
1996: Diesel Regular Non-Locking Fuel Cap .....	10830D		2009-2005: OE Equivalent Fuel Cap .....	10841	
1996: Regular Locking Fuel Cap .....	10591		2009-2005: Regular Locking Fuel Cap .....	10523	
1996: Diesel Only Pre-Vent Locking Fuel Cap .....	10501D		2009-2005: Oil Filler Cap .....	10099	
1996: Diesel Regular Locking Fuel Cap .....	10591D		2004-2002: OE Type Radiator Cap .....	10248	15
1996: Oil Filler Cap .....	10066		2004-2002: OE Equivalent Fuel Cap .....	10836	
1995: Lev-R-Vent Radiator Cap .....	10330	16	2004-2002: Regular Locking Fuel Cap .....	10522	
1995: OE Type Radiator Cap .....	10230	16	2004-2002: Oil Filler Cap .....	10099	
1995: OE Equivalent Fuel Cap .....	10817		<b>V-8 5.3 L</b>		
1995: Diesel Regular Non-Locking Fuel Cap .....	10830D		2009-2005: OE Type Radiator Cap .....	10248	15
1995: Regular Locking Fuel Cap .....	10591		2009-2005: OE Equivalent Fuel Cap .....	10841	
1995: Diesel Regular Locking Fuel Cap .....	10591D		2009-2005: Regular Locking Fuel Cap .....	10523	
1995: Pre-Vent Non-Locking Fuel Cap .....	10819		2009-2005: Oil Filler Cap .....	10099	
1995: Diesel Pre-Vent Non-Locking Fuel Cap .....	10819D		2004-2003: OE Type Radiator Cap .....	10248	15
1995: Pre-Vent Locking Fuel Cap .....	10501		2004-2003: OE Equivalent Fuel Cap .....	10836	
1995: Diesel Only Pre-Vent Locking Fuel Cap .....	10501D		2004-2003: Regular Locking Fuel Cap .....	10522	
1995: Oil Filler Cap .....	10066		2004-2003: Oil Filler Cap .....	10099	
<b>V-8 7.4 L</b>			<b>G Series Van</b>		
2000-1998: Lev-R-Vent Radiator Cap .....	10331	16	<b>V-6 4.3 L</b>		
2000-1998: OE Type Radiator Cap .....	10231	16	1996-1995: Lev-R-Vent Radiator Cap .....	10331	16
2000-1998: OE Equivalent Fuel Cap .....	10834		1996-1995: OE Type Radiator Cap .....	10231	16
2000-1998: Regular Locking Fuel Cap .....	10504		1996-1995: OE Equivalent Fuel Cap .....	10817	
2000-1998: Oil Filler Cap .....	10114		1996-1995: Pre-Vent Non-Locking Fuel Cap .....	10819	
1997-1996: Lev-R-Vent Radiator Cap .....	10331	16	1996-1995: Regular Locking Fuel Cap .....	10591	
1997-1996: OE Type Radiator Cap .....	10231	16	1996-1995: Pre-Vent Locking Fuel Cap .....	10501	
1997-1996: OE Equivalent Fuel Cap .....	10817		1996-1995: Oil Filler Cap .....	10072	
1997-1996: Pre-Vent Non-Locking Fuel Cap .....	10819		<b>V-8 5.0 L</b>		
1997-1996: Regular Locking Fuel Cap .....	10591		1995: Lev-R-Vent Radiator Cap .....	10331	16
1997-1996: Pre-Vent Locking Fuel Cap .....	10501		1995: OE Type Radiator Cap .....	10231	16
1997-1996: Oil Filler Cap .....	10114		1995: OE Equivalent Fuel Cap .....	10817	
1995: Lev-R-Vent Radiator Cap .....	10331	16	1995: Pre-Vent Non-Locking Fuel Cap .....	10819	
1995: OE Type Radiator Cap .....	10231	16	1995: Regular Locking Fuel Cap .....	10591	
1995: OE Equivalent Fuel Cap .....	10817		1995: Pre-Vent Locking Fuel Cap .....	10501	
1995: Pre-Vent Non-Locking Fuel Cap .....	10819		1995: Oil Filler Cap .....	10072	
1995: Regular Locking Fuel Cap .....	10591		<b>V-8 5.7 L</b>		
1995: Pre-Vent Locking Fuel Cap .....	10501		1996-1995: Lev-R-Vent Radiator Cap .....	10331	16
1995: Oil Filler Cap .....	10105		1996-1995: OE Type Radiator Cap .....	10231	16
<b>V-8 8.1 L</b>			1996-1995: OE Equivalent Fuel Cap .....	10817	
2002-2001: Lev-R-Vent Radiator Cap .....	10331	16	1996-1995: Pre-Vent Non-Locking Fuel Cap .....	10819	
2002-2001: OE Type Radiator Cap .....	10231	16	1996-1995: Regular Locking Fuel Cap .....	10591	
2002-2001: OE Equivalent Fuel Cap .....	10834		1996-1995: Pre-Vent Locking Fuel Cap .....	10501	
2002-2001: Regular Locking Fuel Cap .....	10504		1996-1995: Oil Filler Cap .....	10072	
2002-2001: Oil Filler Cap .....	10114		<b>V-8 6.5 L Diesel</b>		
<b>Canyon</b>			1996-1995: Lev-R-Vent Radiator Cap .....	10330	16
<b>4-Cyl. 2.8 L</b>			1996-1995: OE Type Radiator Cap .....	10230	16
2006-2004: OE Type Radiator Cap .....	10248	15	1996-1995: OE Equivalent Fuel Cap .....	10817	
2006-2004: OE Equivalent Fuel Cap .....	10841		1996-1995: Diesel Regular Non-Locking Fuel Cap .....	10830D	
2006-2004: Regular Locking Fuel Cap .....	10511		1996-1995: Regular Locking Fuel Cap .....	10591	
2006-2004: Oil Filler Cap .....	10099		1996-1995: Diesel Regular Locking Fuel Cap .....	10591D	
<b>4-Cyl. 2.9 L</b>			1996-1995: Pre-Vent Non-Locking Fuel Cap .....	10819	
2011-2007: OE Type Radiator Cap .....	10248	15	1996-1995: Diesel Pre-Vent Non-Locking Fuel Cap .....	10819D	
2011-2007: OE Equivalent Fuel Cap .....	10841		1996-1995: Pre-Vent Locking Fuel Cap .....	10501	
2011-2007: Regular Locking Fuel Cap .....	10511		1996-1995: Diesel Only Pre-Vent Locking Fuel Cap .....	10501D	
2011-2007: Oil Filler Cap .....	10099		1996-1995: Oil Filler Cap .....	10066	
<b>5-Cyl. 3.5 L</b>			<b>V-8 7.4 L</b>		
2006-2004: OE Type Radiator Cap .....	10248	15	1996-1995: Lev-R-Vent Radiator Cap .....	10331	16
2006-2004: OE Equivalent Fuel Cap .....	10841		1996-1995: OE Type Radiator Cap .....	10231	16
2006-2004: Regular Locking Fuel Cap .....	10511		1996-1995: OE Equivalent Fuel Cap .....	10817	
2006-2004: Oil Filler Cap .....	10099		1996-1995: Pre-Vent Non-Locking Fuel Cap .....	10819	
<b>5-Cyl. 3.7 L</b>			1996-1995: Regular Locking Fuel Cap .....	10591	
2011-2007: OE Type Radiator Cap .....	10248	15	1996-1995: Pre-Vent Locking Fuel Cap .....	10501	
2011-2007: OE Equivalent Fuel Cap .....	10841		1996-1995: Oil Filler Cap .....	10105	
2011-2007: Regular Locking Fuel Cap .....	10511				
2011-2007: Oil Filler Cap .....	10099				

## Caps for Passenger Cars and Light Trucks (1990 and Newer)

Application	Part Number	PSI	Application	Part Number	PSI
<b>GMC - Continued</b>			<b>GMC - Continued</b>		
<b>Jimmy</b>			<b>P Series Van - Continued</b>		
<b>V-6 4.3 L</b>			<b>V-8 6.5 L Diesel - Continued</b>		
2001-1996; Lev-R-Vent Radiator Cap .....	10330	16	1997-1995; Diesel Regular Locking Fuel Cap .....	10591D	
2001-1996; OE Type Radiator Cap .....	10230	16	1997-1995; Pre-Vent Non-Locking Fuel Cap .....	10819	
2001-1996; OE Equivalent Fuel Cap .....	10836		1997-1995; Diesel Pre-Vent Non-Locking Fuel Cap .....	10819D	
2001-1996; Regular Locking Fuel Cap .....	10506		1997-1995; Pre-Vent Locking Fuel Cap .....	10501	
2001-1996; Oil Filler Cap .....	10099		1997-1995; Diesel Only Pre-Vent Locking Fuel Cap .....	10501D	
1995; Lev-R-Vent Radiator Cap .....	10331	16	1997-1995; Oil Filler Cap .....	10066	
1995; OE Type Radiator Cap .....	10231	16			
1995; OE Equivalent Fuel Cap .....	10817		<b>V-8 7.4 L</b>		
1995; Pre-Vent Non-Locking Fuel Cap .....	10819		1999; Lev-R-Vent Radiator Cap .....	10330	16
1995; Regular Locking Fuel Cap .....	10591		1999; OE Type Radiator Cap .....	10230	16
1995; Pre-Vent Locking Fuel Cap .....	10501		1999; OE Equivalent Fuel Cap .....	10836	
1995; Oil Filler Cap .....	10099		1999; Regular Locking Fuel Cap .....	10506	
			1999; Oil Filler Cap .....	10114	
<b>V-6 4.3 L (Canada)</b>			1998; Lev-R-Vent Radiator Cap .....	10330	16
2005-2002; Lev-R-Vent Radiator Cap .....	10330	16	1998; OE Type Radiator Cap .....	10230	16
2005-2002; OE Type Radiator Cap .....	10230	16	1998; OE Equivalent Fuel Cap .....	10836	
2005-2002; OE Equivalent Fuel Cap .....	10836		1998; Regular Locking Fuel Cap .....	10506	
2005-2002; Regular Locking Fuel Cap .....	10506		1998; Oil Filler Cap; Eng. VIN J .....	10114	
2005-2002; Oil Filler Cap .....	10099		1997-1996; Lev-R-Vent Radiator Cap .....	10330	16
			1997-1996; OE Type Radiator Cap .....	10230	16
<b>P Series Van</b>			1997-1996; OE Equivalent Fuel Cap .....	10817	
<b>V-6 4.3 L</b>			1997-1996; Pre-Vent Non-Locking Fuel Cap .....	10819	
1999-1998; Lev-R-Vent Radiator Cap .....	10330	16	1997-1996; Regular Locking Fuel Cap .....	10591	
1999-1998; OE Type Radiator Cap .....	10230	16	1997-1996; Pre-Vent Locking Fuel Cap .....	10501	
1999-1998; OE Equivalent Fuel Cap .....	10836		1997-1996; Oil Filler Cap .....	10114	
1999-1998; Regular Locking Fuel Cap .....	10506		1995; Lev-R-Vent Radiator Cap .....	10330	16
1999-1998; Oil Filler Cap .....	10114		1995; OE Type Radiator Cap .....	10230	16
1997-1996; Lev-R-Vent Radiator Cap .....	10330	16	1995; OE Equivalent Fuel Cap .....	10817	
1997-1996; OE Type Radiator Cap .....	10230	16	1995; Pre-Vent Non-Locking Fuel Cap .....	10819	
1997-1996; OE Equivalent Fuel Cap .....	10817		1995; Regular Locking Fuel Cap .....	10591	
1997-1996; Pre-Vent Non-Locking Fuel Cap .....	10819		1995; Pre-Vent Locking Fuel Cap .....	10501	
1997-1996; Regular Locking Fuel Cap .....	10591		1995; Oil Filler Cap .....	10105	
1997-1996; Pre-Vent Locking Fuel Cap .....	10501				
1997-1996; Oil Filler Cap .....	10114		<b>Safari</b>		
1995; Lev-R-Vent Radiator Cap .....	10330	16	<b>V-6 4.3 L</b>		
1995; OE Type Radiator Cap .....	10230	16	2005-1997; Lev-R-Vent Radiator Cap .....	10331	16
1995; OE Equivalent Fuel Cap .....	10817		2005-1997; OE Type Radiator Cap .....	10231	16
1995; Pre-Vent Non-Locking Fuel Cap .....	10819		2005-1997; OE Equivalent Fuel Cap .....	10836	
1995; Regular Locking Fuel Cap .....	10591		2005-1997; Regular Locking Fuel Cap .....	10506	
1995; Pre-Vent Locking Fuel Cap .....	10501		2005-1997; Oil Filler Cap .....	10114	
1995; Oil Filler Cap .....	10072		1996; Lev-R-Vent Radiator Cap .....	10331	16
			1996; OE Type Radiator Cap .....	10231	16
<b>V-8 5.7 L</b>			1996; OE Equivalent Fuel Cap .....	10817	
1999-1998; Lev-R-Vent Radiator Cap .....	10330	16	1996; Pre-Vent Non-Locking Fuel Cap .....	10819	
1999-1998; OE Type Radiator Cap .....	10230	16	1996; Regular Locking Fuel Cap .....	10591	
1999-1998; OE Equivalent Fuel Cap .....	10836		1996; Pre-Vent Locking Fuel Cap .....	10501	
1999-1998; Regular Locking Fuel Cap .....	10506		1996; Oil Filler Cap .....	10114	
1999-1998; Oil Filler Cap .....	10114		1995; Lev-R-Vent Radiator Cap .....	10331	16
1997-1996; Lev-R-Vent Radiator Cap .....	10330	16	1995; OE Type Radiator Cap .....	10231	16
1997-1996; OE Type Radiator Cap .....	10230	16	1995; OE Equivalent Fuel Cap .....	10817	
1997-1996; OE Equivalent Fuel Cap .....	10817		1995; Pre-Vent Non-Locking Fuel Cap .....	10819	
1997-1996; Pre-Vent Non-Locking Fuel Cap .....	10819		1995; Regular Locking Fuel Cap .....	10591	
1997-1996; Regular Locking Fuel Cap .....	10591		1995; Pre-Vent Locking Fuel Cap .....	10501	
1997-1996; Pre-Vent Locking Fuel Cap .....	10501		1995; Oil Filler Cap .....	10072	
1997-1996; Oil Filler Cap .....	10114				
1995; Lev-R-Vent Radiator Cap .....	10330	16	<b>Savana</b>		
1995; OE Type Radiator Cap .....	10230	16	<b>V-6 4.3 L</b>		
1995; OE Equivalent Fuel Cap .....	10817		2011-2006; OE Type Radiator Cap .....	10248	15
1995; Pre-Vent Non-Locking Fuel Cap .....	10819		2011-2006; OE Equivalent Fuel Cap .....	10841	
1995; Regular Locking Fuel Cap .....	10591		2011-2006; Regular Locking Fuel Cap .....	10511	
1995; Pre-Vent Locking Fuel Cap .....	10501		2011-2006; Oil Filler Cap .....	10099	
1995; Oil Filler Cap .....	10066		2005; OE Type Radiator Cap .....	10248	15
			2005; OE Equivalent Fuel Cap .....	10848	
<b>V-8 6.5 L Diesel</b>			2005; Regular Locking Fuel Cap .....	10518	
1999-1998; Lev-R-Vent Radiator Cap .....	10330	16	2005; Oil Filler Cap .....	10099	
1999-1998; OE Type Radiator Cap .....	10230	16	2004; OE Type Radiator Cap .....	10248	15
1999-1998; OE Equivalent Fuel Cap .....	10836		2004; OE Equivalent Fuel Cap .....	10836	
1999-1998; Regular Locking Fuel Cap .....	10506		2004; Regular Locking Fuel Cap .....	10506	
1999-1998; Oil Filler Cap; Eng. VIN F .....	10066		2004; Oil Filler Cap .....	10099	
1999-1998; Oil Filler Cap; Eng. VIN Y .....	10099		2003; OE Type Radiator Cap .....	10248	15
1997-1995; Lev-R-Vent Radiator Cap .....	10330	16	2003; OE Equivalent Fuel Cap .....	10836	
1997-1995; OE Type Radiator Cap .....	10230	16	2003; Regular Locking Fuel Cap .....	10522	
1997-1995; OE Equivalent Fuel Cap .....	10817		2003; Oil Filler Cap .....	10099	
1997-1995; Diesel Regular Non-Locking Fuel Cap .....	10830D		2002-1998; Lev-R-Vent Radiator Cap .....	10331	16
1997-1995; Regular Locking Fuel Cap .....	10591				

## Caps for Passenger Cars and Light Trucks (1990 and Newer)

Application	Part Number	PSI	Application	Part Number	PSI
<b>GMC - Continued</b>			<b>GMC - Continued</b>		
<b>Savana - Continued</b>			<b>Savana - Continued</b>		
<b>V-6 4.3 L - Continued</b>			<b>V-8 5.3 L - Continued</b>		
2002-1998; OE Type Radiator Cap .....	10231	16	2005-2004; OE Type Radiator Cap .....	10248	15
2002-1998; OE Equivalent Fuel Cap .....	10836		2005-2004; OE Equivalent Fuel Cap .....	10848	
2002-1998; Regular Locking Fuel Cap .....	10522		2005-2004; Regular Locking Fuel Cap .....	10518	
2002-1998; Oil Filler Cap .....	10114		2005-2004; Oil Filler Cap .....	10099	
1997-1996; Lev-R-Vent Radiator Cap .....	10331	16	2003; OE Type Radiator Cap .....	10248	15
1997-1996; OE Type Radiator Cap .....	10231	16	2003; OE Equivalent Fuel Cap .....	10836	
1997-1996; OE Equivalent Fuel Cap .....	10817		2003; Regular Locking Fuel Cap .....	10522	
1997-1996; Pre-Vent Non-Locking Fuel Cap .....	10819		2003; Oil Filler Cap .....	10099	
1997-1996; Regular Locking Fuel Cap .....	10591				
1997-1996; Pre-Vent Locking Fuel Cap .....	10501		<b>V-8 5.7 L</b>		
1997-1996; Oil Filler Cap .....	10114		2002-1998; Lev-R-Vent Radiator Cap .....	10331	16
			2002-1998; OE Type Radiator Cap .....	10231	16
<b>V-8 4.8 L</b>			2002-1998; OE Equivalent Fuel Cap .....	10836	
2011-2010; OE Type Radiator Cap .....	10248	15	2002-1998; Regular Locking Fuel Cap .....	10522	
2011-2010; OE Equivalent Fuel Cap .....	10841		2002-1998; Oil Filler Cap .....	10114	
2011-2010; Regular Locking Fuel Cap .....	10511		1997-1996; Lev-R-Vent Radiator Cap .....	10331	16
2011-2010; Flex Fuel Regular Fuel Cap .....	10841Y		1997-1996; OE Type Radiator Cap .....	10231	16
2011-2010; Flex Fuel Regular Locking Fuel Cap .....	10511Y		1997-1996; OE Equivalent Fuel Cap .....	10817	
2011-2010; Oil Filler Cap .....	10099		1997-1996; Pre-Vent Non-Locking Fuel Cap .....	10819	
2009-2006; OE Type Radiator Cap .....	10248	15	1997-1996; Regular Locking Fuel Cap .....	10591	
2009-2006; OE Equivalent Fuel Cap .....	10841		1997-1996; Pre-Vent Locking Fuel Cap .....	10501	
2009-2006; Regular Locking Fuel Cap .....	10511		1997-1996; Oil Filler Cap .....	10114	
2009-2006; Oil Filler Cap .....	10099				
2005-2004; OE Type Radiator Cap .....	10248	15	<b>V-8 6.0 L</b>		
2005-2004; OE Equivalent Fuel Cap .....	10848		2012; OE Type Radiator Cap .....	10248	15
2005-2004; Regular Locking Fuel Cap .....	10518		2011-2010; OE Type Radiator Cap .....	10248	15
2005-2004; Oil Filler Cap .....	10099		2011-2010; OE Equivalent Fuel Cap .....	10841	
2003; OE Type Radiator Cap .....	10248	15	2011-2010; Regular Locking Fuel Cap .....	10511	
2003; OE Equivalent Fuel Cap .....	10836		2011-2010; Flex Fuel Regular Fuel Cap .....	10841Y	
2003; Regular Locking Fuel Cap .....	10522		2011-2010; Flex Fuel Regular Locking Fuel Cap .....	10511Y	
2003; Oil Filler Cap .....	10099		2011-2010; Oil Filler Cap .....	10099	
			2009-2006; OE Type Radiator Cap .....	10248	15
<b>V-8 5.0 L</b>			2009-2006; OE Equivalent Fuel Cap .....	10841	
2002-1998; Lev-R-Vent Radiator Cap .....	10331	16	2009-2006; Regular Locking Fuel Cap .....	10511	
2002-1998; OE Type Radiator Cap .....	10231	16	2009-2006; Oil Filler Cap .....	10099	
2002-1998; OE Equivalent Fuel Cap .....	10836		2005-2004; OE Type Radiator Cap .....	10248	15
2002-1998; Regular Locking Fuel Cap .....	10522		2005-2004; OE Equivalent Fuel Cap .....	10848	
2002-1998; Oil Filler Cap .....	10114		2005-2004; Regular Locking Fuel Cap .....	10518	
1997-1996; Lev-R-Vent Radiator Cap .....	10331	16	2005-2004; Oil Filler Cap .....	10099	
1997-1996; OE Type Radiator Cap .....	10231	16	2003; OE Type Radiator Cap .....	10248	15
1997-1996; OE Equivalent Fuel Cap .....	10817		2003; OE Equivalent Fuel Cap .....	10836	
1997-1996; Pre-Vent Non-Locking Fuel Cap .....	10819		2003; Regular Locking Fuel Cap .....	10522	
1997-1996; Regular Locking Fuel Cap .....	10591		2003; Oil Filler Cap .....	10099	
1997-1996; Pre-Vent Locking Fuel Cap .....	10501				
1997-1996; Oil Filler Cap .....	10114		<b>V-8 6.5 L Diesel</b>		
			2002; Lev-R-Vent Radiator Cap .....	10330	16
<b>V-8 5.3 L</b>			2002; OE Type Radiator Cap .....	10230	16
2011; OE Type Radiator Cap .....	10248	15	2002; OE Equivalent Fuel Cap .....	10830	
2011; OE Equivalent Fuel Cap .....	10841		2002; Diesel Regular Non-Locking Fuel Cap .....	10830D	
2011; Regular Locking Fuel Cap .....	10511		2002; Regular Locking Fuel Cap .....	10591	
2011; Flex Fuel Regular Fuel Cap .....	10841Y		2002; Diesel Regular Locking Fuel Cap .....	10591D	
2011; Flex Fuel Regular Locking Fuel Cap .....	10511Y		2002; Oil Filler Cap .....	10099	
2011; Oil Filler Cap .....	10099		2001; OE Type Radiator Cap .....	10248	15
2010-2009; OE Type Radiator Cap .....	10248	15	2001; OE Equivalent Fuel Cap .....	10830	
2010-2009; OE Equivalent Fuel Cap .....	10841		2001; Diesel Regular Non-Locking Fuel Cap .....	10830D	
2010-2009; Flex Fuel Regular Fuel Cap .....	10841Y		2001; Regular Locking Fuel Cap .....	10591	
2010-2009; Regular Locking Fuel Cap .....	10511		2001; Diesel Regular Locking Fuel Cap .....	10591D	
2010-2009; Flex Fuel Regular Locking Fuel Cap .....	10511Y		2001; Oil Filler Cap .....	10099	
2010-2009; Oil Filler Cap .....	10099		2000; Lev-R-Vent Radiator Cap .....	10331	16
2008; OE Type Radiator Cap .....	10248	15	2000; OE Type Radiator Cap .....	10231	16
2008; OE Equivalent Fuel Cap .....	10841		2000; OE Equivalent Fuel Cap .....	10830	
2008; Regular Locking Fuel Cap .....	10511		2000; Diesel Regular Non-Locking Fuel Cap .....	10830D	
2008; Flex Fuel Regular Fuel Cap .....	10841Y		2000; Regular Locking Fuel Cap .....	10591	
2008; Flex Fuel Regular Locking Fuel Cap .....	10511Y		2000; Diesel Regular Locking Fuel Cap .....	10591D	
2008; Oil Filler Cap .....	10099		2000; Oil Filler Cap .....	10099	
2007; OE Type Radiator Cap .....	10248	15	1999; Lev-R-Vent Radiator Cap .....	10330	16
2007; OE Equivalent Fuel Cap .....	10841		1999; OE Type Radiator Cap .....	10230	16
2007; Flex Fuel Regular Fuel Cap .....	10841Y		1999; OE Equivalent Fuel Cap .....	10836	
2007; Regular Locking Fuel Cap .....	10511		1999; Regular Locking Fuel Cap .....	10522	
2007; Flex Fuel Regular Locking Fuel Cap .....	10511Y		1999; Oil Filler Cap .....	10099	
2007; Oil Filler Cap .....	10099		1998; Lev-R-Vent Radiator Cap .....	10330	16
2006; OE Type Radiator Cap .....	10248	15	1998; OE Type Radiator Cap .....	10230	16
2006; OE Equivalent Fuel Cap .....	10841		1998; OE Equivalent Fuel Cap .....	10817	
2006; Regular Locking Fuel Cap .....	10511		1998; Diesel Regular Non-Locking Fuel Cap .....	10830D	
2006; Oil Filler Cap .....	10099		1998; Regular Locking Fuel Cap .....	10591	

## Caps for Passenger Cars and Light Trucks (1990 and Newer)

Application	Part Number	PSI	Application	Part Number	PSI
<b>GMC - Continued</b>			<b>GMC - Continued</b>		
<b>Savana - Continued</b>			<b>Savana - Continued</b>		
<b>V-8 6.5 L Diesel - Continued</b>			<b>V-8 7.4 L - Continued</b>		
1998: Diesel Regular Locking Fuel Cap .....	10591D		1998: OE Type Radiator Cap .....	10231	16
1998: Pre-Vent Non-Locking Fuel Cap .....	10819		1998: OE Equivalent Fuel Cap .....	10836	
1998: Diesel Pre-Vent Non-Locking Fuel Cap .....	10819D		1998: Regular Locking Fuel Cap .....	10506	
1998: Pre-Vent Locking Fuel Cap .....	10501		1997-1996: Lev-R-Vent Radiator Cap .....	10331	16
1998: Diesel Only Pre-Vent Locking Fuel Cap .....	10501D		1997-1996: OE Type Radiator Cap .....	10231	16
1998: Oil Filler Cap .....	10099		1997-1996: OE Equivalent Fuel Cap .....	10817	
1997: Lev-R-Vent Radiator Cap .....	10330	16	1997-1996: Pre-Vent Non-Locking Fuel Cap .....	10819	
1997: OE Type Radiator Cap .....	10230	16	1997-1996: Regular Locking Fuel Cap .....	10591	
1997: OE Equivalent Fuel Cap .....	10817		1997-1996: Pre-Vent Locking Fuel Cap .....	10501	
1997: Diesel Regular Non-Locking Fuel Cap .....	10830D		1997-1996: Oil Filler Cap .....	10114	
1997: Regular Locking Fuel Cap .....	10591		<b>V-8 8.1 L</b>		
1997: Diesel Regular Locking Fuel Cap .....	10591D		2002-2001: Lev-R-Vent Radiator Cap .....	10331	16
1997: Pre-Vent Non-Locking Fuel Cap .....	10819		2002-2001: OE Type Radiator Cap .....	10231	16
1997: Diesel Pre-Vent Non-Locking Fuel Cap .....	10819D		2002-2001: OE Equivalent Fuel Cap .....	10836	
1997: Pre-Vent Locking Fuel Cap .....	10501		2002-2001: Regular Locking Fuel Cap .....	10522	
1997: Diesel Only Pre-Vent Locking Fuel Cap .....	10501D		2002-2001: Oil Filler Cap .....	10114	
1997: Oil Filler Cap: W/Metal Oil Cap .....	10066		<b>Sierra Series Pickup</b>		
1997: Oil Filler Cap: W/O Metal Oil Cap .....	10099		<b>V-6 4.3 L</b>		
1996: Lev-R-Vent Radiator Cap .....	10330	16	2011: OE Equivalent Fuel Cap .....	10841	
1996: OE Type Radiator Cap .....	10230	16	2011: Regular Locking Fuel Cap .....	10511	
1996: OE Equivalent Fuel Cap .....	10817		2011: Oil Filler Cap .....	10099	
1996: Diesel Regular Non-Locking Fuel Cap .....	10830D		2010-2005: OE Type Radiator Cap .....	10248	15
1996: Regular Locking Fuel Cap .....	10591		2010-2005: OE Equivalent Fuel Cap .....	10841	
1996: Diesel Regular Locking Fuel Cap .....	10591D		2010-2005: Regular Locking Fuel Cap .....	10511	
1996: Pre-Vent Non-Locking Fuel Cap .....	10819		2010-2005: Oil Filler Cap .....	10099	
1996: Diesel Pre-Vent Non-Locking Fuel Cap .....	10819D		2004: OE Type Radiator Cap .....	10248	15
1996: Pre-Vent Locking Fuel Cap .....	10501		2004: OE Equivalent Fuel Cap: W/O Threaded Filler Neck .....	10841	
1996: Diesel Only Pre-Vent Locking Fuel Cap .....	10501D		2004: Regular Locking Fuel Cap: W/O Threaded Filler Neck .....	10511	
1996: Oil Filler Cap .....	10066		2004: OE Equivalent Fuel Cap: W/Threaded Filler Neck .....	10834	
<b>V-8 6.6 L Diesel</b>			2004: Regular Locking Fuel Cap: W/Threaded Filler Neck .....	10504	
2011: OE Equivalent Fuel Cap .....	10817		2004: Oil Filler Cap .....	10099	
2011: Diesel Regular Non-Locking Fuel Cap .....	10830D		2003-1999: OE Type Radiator Cap .....	10248	15
2011: Regular Locking Fuel Cap .....	10591		2003-1999: OE Equivalent Fuel Cap .....	10834	
2011: Diesel Regular Locking Fuel Cap .....	10591D		2003-1999: Regular Locking Fuel Cap .....	10504	
2011: Pre-Vent Non-Locking Fuel Cap .....	10819		2003-1999: Oil Filler Cap .....	10099	
2011: Diesel Pre-Vent Non-Locking Fuel Cap .....	10819D		<b>V-8 4.8 L</b>		
2011: Pre-Vent Locking Fuel Cap .....	10501		2011: OE Equivalent Fuel Cap .....	10841	
2011: Diesel Only Pre-Vent Locking Fuel Cap .....	10501D		2011: Regular Locking Fuel Cap .....	10511	
2011: Oil Filler Cap .....	10099		2011: Flex Fuel Regular Fuel Cap .....	10841Y	
2010: OE Type Radiator Cap .....	10248	15	2011: Flex Fuel Regular Locking Fuel Cap .....	10511Y	
2010: OE Equivalent Fuel Cap .....	10817		2011: Oil Filler Cap .....	10099	
2010: Diesel Regular Non-Locking Fuel Cap .....	10830D		2010: OE Type Radiator Cap .....	10248	15
2010: Regular Locking Fuel Cap .....	10591		2010: OE Equivalent Fuel Cap .....	10841	
2010: Diesel Regular Locking Fuel Cap .....	10591D		2010: Regular Locking Fuel Cap .....	10511	
2010: Pre-Vent Non-Locking Fuel Cap .....	10819		2010: Flex Fuel Regular Fuel Cap .....	10841Y	
2010: Diesel Pre-Vent Non-Locking Fuel Cap .....	10819D		2010: Flex Fuel Regular Locking Fuel Cap .....	10511Y	
2010: Pre-Vent Locking Fuel Cap .....	10501		2010: Oil Filler Cap .....	10099	
2010: Diesel Only Pre-Vent Locking Fuel Cap .....	10501D		2009-2005: OE Type Radiator Cap .....	10248	15
2010: Oil Filler Cap .....	10099		2009-2005: OE Equivalent Fuel Cap .....	10841	
2009: OE Type Radiator Cap .....	10248	15	2009-2005: Regular Locking Fuel Cap .....	10511	
2009: OE Equivalent Fuel Cap .....	10830		2009-2005: Oil Filler Cap .....	10099	
2009: Diesel Regular Non-Locking Fuel Cap .....	10830D		2004: OE Type Radiator Cap .....	10248	15
2009: Pre-Vent Non-Locking Fuel Cap .....	10819		2004: OE Equivalent Fuel Cap: W/O Threaded Filler Neck .....	10841	
2009: Diesel Pre-Vent Non-Locking Fuel Cap .....	10819D		2004: Regular Locking Fuel Cap: W/O Threaded Filler Neck .....	10511	
2009: Regular Locking Fuel Cap .....	10591		2004: OE Equivalent Fuel Cap: W/Threaded Filler Neck .....	10834	
2009: Diesel Regular Locking Fuel Cap .....	10591D		2004: Regular Locking Fuel Cap: W/Threaded Filler Neck .....	10504	
2009: Pre-Vent Locking Fuel Cap .....	10501		2004: Oil Filler Cap .....	10099	
2009: Diesel Only Pre-Vent Locking Fuel Cap .....	10501D		2003-1999: OE Type Radiator Cap .....	10248	15
2009: Oil Filler Cap .....	10099		2003-1999: OE Equivalent Fuel Cap .....	10834	
2008-2006: OE Type Radiator Cap .....	10248	15	2003-1999: Regular Locking Fuel Cap .....	10504	
2008-2006: OE Equivalent Fuel Cap .....	10830		2003-1999: Oil Filler Cap .....	10099	
2008-2006: Diesel Regular Non-Locking Fuel Cap .....	10830D		<b>V-8 5.3 L</b>		
2008-2006: Regular Locking Fuel Cap .....	10591		2011: OE Equivalent Fuel Cap .....	10841	
2008-2006: Diesel Regular Locking Fuel Cap .....	10591D		2011: Regular Locking Fuel Cap .....	10511	
2008-2006: Oil Filler Cap .....	10099		2011: Flex Fuel Regular Fuel Cap .....	10841Y	
<b>V-8 7.4 L</b>			2011: Flex Fuel Regular Locking Fuel Cap .....	10511Y	
2000-1999: Lev-R-Vent Radiator Cap .....	10331	16	2011: Oil Filler Cap .....	10099	
2000-1999: OE Type Radiator Cap .....	10231	16	2010-2007: OE Type Radiator Cap .....	10248	15
2000-1999: OE Equivalent Fuel Cap .....	10836		2010-2007: OE Equivalent Fuel Cap .....	10841	
2000-1999: Regular Locking Fuel Cap .....	10522		2010-2007: Regular Locking Fuel Cap .....	10511	
2000-1999: Oil Filler Cap .....	10114		2010-2007: Flex Fuel Regular Fuel Cap .....	10841Y	
1998: Lev-R-Vent Radiator Cap .....	10331	16			

## Caps for Passenger Cars and Light Trucks (1990 and Newer)

Application	Part Number	PSI	Application	Part Number	PSI
<b>GMC - Continued</b>			<b>GMC - Continued</b>		
<b>Sierra Series Pickup - Continued</b>			<b>Sierra Series Pickup - Continued</b>		
<b>V-8 5.3 L - Continued</b>			<b>V-8 6.0 L Electric Assist</b>		
2010-2007: Flex Fuel Regular Locking Fuel Cap .....	10511Y		2010-2009: OE Type Radiator Cap .....	10248	15
2010-2007: Oil Filler Cap .....	10099		2010-2009: OE Equivalent Fuel Cap .....	10841	
2006-2005: OE Type Radiator Cap .....	10248	15	2010-2009: Regular Locking Fuel Cap .....	10511	
2006-2005: OE Equivalent Fuel Cap .....	10841		2010-2009: Oil Filler Cap .....	10099	
2006-2005: Flex Fuel Regular Fuel Cap .....	10841Y		<b>V-8 6.2 L</b>		
2006-2005: Regular Locking Fuel Cap .....	10511		2011: OE Equivalent Fuel Cap .....	10841	
2006-2005: Flex Fuel Regular Locking Fuel Cap .....	10511Y		2011: Regular Locking Fuel Cap .....	10511	
2006-2005: Oil Filler Cap .....	10099		2011: Flex Fuel Regular Fuel Cap .....	10841Y	
2004: OE Type Radiator Cap .....	10248	15	2011: Flex Fuel Regular Locking Fuel Cap .....	10511Y	
2004: OE Equivalent Fuel Cap; W/O Threaded Filler Neck .....	10841		2011: Oil Filler Cap .....	10099	
2004: Flex Fuel Regular Fuel Cap; W/O Threaded Filler Neck ...	10841Y		2010: OE Type Radiator Cap .....	10248	15
2004: Regular Locking Fuel Cap; W/O Threaded Filler Neck .....	10511		2010: OE Equivalent Fuel Cap .....	10841	
2004: Flex Fuel Regular Locking Fuel Cap; W/O Threaded Filler Neck .....	10511Y		2010: Regular Locking Fuel Cap .....	10511	
2004: OE Equivalent Fuel Cap; W/Threaded Filler Neck .....	10834		2010: Flex Fuel Regular Fuel Cap .....	10841Y	
2004: Flex Fuel Regular Fuel Cap; W/Threaded Filler Neck .....	10834Y		2010: Flex Fuel Regular Locking Fuel Cap .....	10511Y	
2004: Regular Locking Fuel Cap; W/Threaded Filler Neck .....	10504		2010: Oil Filler Cap .....	10099	
2004: Flex Fuel Regular Locking Fuel Cap; W/Threaded Filler Neck .....	10504Y		2009-2008: OE Type Radiator Cap .....	10248	15
2004: Oil Filler Cap .....	10099		2009-2008: OE Equivalent Fuel Cap .....	10841	
2003-2002: OE Type Radiator Cap .....	10248	15	2009-2008: Regular Locking Fuel Cap .....	10511	
2003-2002: OE Equivalent Fuel Cap .....	10834		2009-2008: Oil Filler Cap .....	10099	
2003-2002: Flex Fuel Regular Fuel Cap .....	10834Y		2007: OE Type Radiator Cap .....	10248	15
2003-2002: Regular Locking Fuel Cap .....	10504		2007: OE Equivalent Fuel Cap .....	10841	
2003-2002: Flex Fuel Regular Locking Fuel Cap .....	10504Y		2007: Regular Locking Fuel Cap .....	10511	
2003-2002: Oil Filler Cap .....	10099		<b>V-8 6.5 L Diesel</b>		
2001-1999: OE Type Radiator Cap .....	10248	15	1999: Oil Filler Cap .....	10099	
2001-1999: OE Equivalent Fuel Cap .....	10834		<b>V-8 6.6 L Diesel</b>		
2001-1999: Regular Locking Fuel Cap .....	10504		2011: OE Equivalent Fuel Cap .....	10830	
2001-1999: Oil Filler Cap .....	10099		2011: Regular Locking Fuel Cap .....	10591	
<b>V-8 5.3 L Electric Assist</b>			2011: Diesel Regular Non-Locking Fuel Cap .....	10830D	
2007-2004: OE Type Radiator Cap .....	10248	15	2011: Diesel Regular Locking Fuel Cap .....	10591D	
2007-2004: OE Equivalent Fuel Cap .....	10841		2011: Oil Filler Cap .....	10099	
2007-2004: Regular Locking Fuel Cap .....	10511		2010-2001: OE Type Radiator Cap .....	10248	15
2007-2004: Oil Filler Cap .....	10099		2010-2001: OE Equivalent Fuel Cap .....	10830	
<b>V-8 6.0 L</b>			2010-2001: Diesel Regular Non-Locking Fuel Cap .....	10830D	
2011: OE Equivalent Fuel Cap; 2500, 3500 .....	10834		2010-2001: Regular Locking Fuel Cap .....	10591	
2011: Flex Fuel Regular Fuel Cap; 2500, 3500 .....	10834Y		2010-2001: Diesel Regular Locking Fuel Cap .....	10591D	
2011: Regular Locking Fuel Cap; 2500, 3500 .....	10504		2010-2001: Oil Filler Cap .....	10099	
2011: Flex Fuel Regular Locking Fuel Cap; 2500, 3500 .....	10504Y		<b>V-8 8.1 L</b>		
2011: Oil Filler Cap .....	10099		2007: OE Type Radiator Cap .....	10248	15
2010: OE Type Radiator Cap .....	10248	15	2007: OE Equivalent Fuel Cap; W/Threaded Filler Neck .....	10834	
2010: OE Equivalent Fuel Cap; W/O Threaded Filler Neck .....	10841		2007: Regular Locking Fuel Cap; W/Threaded Filler Neck .....	10504	
2010: Regular Locking Fuel Cap; W/O Threaded Filler Neck .....	10511		2007: OE Equivalent Fuel Cap; W/O Threaded Filler Neck .....	10841	
2010: Flex Fuel Regular Fuel Cap; W/O Threaded Filler Neck ...	10841Y		2007: Regular Locking Fuel Cap; W/O Threaded Filler Neck .....	10511	
2010: Flex Fuel Regular Locking Fuel Cap; W/O Threaded Filler Neck .....	10511Y		2007: Oil Filler Cap .....	10099	
2010: OE Equivalent Fuel Cap; W/Threaded Filler Neck .....	10834		2006: OE Type Radiator Cap .....	10248	15
2010: Regular Locking Fuel Cap; W/Threaded Filler Neck .....	10504		2006: OE Equivalent Fuel Cap; W/O Threaded Filler Neck .....	10841	
2010: Oil Filler Cap .....	10099		2006: Regular Locking Fuel Cap; W/O Threaded Filler Neck .....	10511	
2009-2008: OE Type Radiator Cap .....	10248	15	2006: OE Equivalent Fuel Cap; W/Threaded Filler Neck .....	10834	
2009-2008: OE Equivalent Fuel Cap .....	10841		2006: Regular Locking Fuel Cap; W/Threaded Filler Neck .....	10504	
2009-2008: Regular Locking Fuel Cap .....	10511		2006: Oil Filler Cap .....	10099	
2009-2008: Oil Filler Cap .....	10099		2005: OE Type Radiator Cap .....	10248	15
2007: OE Type Radiator Cap .....	10248	15	2005: OE Equivalent Fuel Cap; W/O Threaded Fuel Cap .....	10841	
2007: OE Equivalent Fuel Cap; W/Threaded Filler Neck .....	10834		2005: Regular Locking Fuel Cap; W/O Threaded Fuel Cap .....	10511	
2007: Regular Locking Fuel Cap; W/Threaded Filler Neck .....	10504		2005: OE Equivalent Fuel Cap; W/Threaded Fuel Cap .....	10834	
2007: OE Equivalent Fuel Cap; W/O Threaded Filler Neck .....	10841		2005: Regular Locking Fuel Cap; W/Threaded Fuel Cap .....	10504	
2007: Regular Locking Fuel Cap; W/O Threaded Filler Neck .....	10511		2005: Oil Filler Cap .....	10099	
2007: Oil Filler Cap .....	10099		2004: OE Type Radiator Cap .....	10248	15
2006-2004: OE Type Radiator Cap .....	10248	15	2004: OE Equivalent Fuel Cap; W/O Threaded Filler Neck .....	10841	
2006-2004: OE Equivalent Fuel Cap; W/O Threaded Filler Neck .	10841		2004: Regular Locking Fuel Cap; W/O Threaded Filler Neck .....	10511	
2006-2004: Regular Locking Fuel Cap; W/O Threaded Filler Neck .....	10511		2004: OE Equivalent Fuel Cap; W/Threaded Filler Neck .....	10834	
2006-2004: OE Equivalent Fuel Cap; W/Threaded Filler Neck ...	10834		2004: Regular Locking Fuel Cap; W/Threaded Filler Neck .....	10504	
2006-2004: Regular Locking Fuel Cap; W/Threaded Filler Neck .	10504		2004: Oil Filler Cap .....	10099	
2006-2004: Oil Filler Cap .....	10099		2003: OE Type Radiator Cap .....	10248	15
2003-1999: OE Type Radiator Cap .....	10248	15	2003: OE Equivalent Fuel Cap .....	10834	
2003-1999: OE Equivalent Fuel Cap .....	10834		2003: Regular Locking Fuel Cap .....	10504	
2003-1999: Regular Locking Fuel Cap .....	10504		2003: Oil Filler Cap .....	10099	
2003-1999: Oil Filler Cap .....	10099		2002-2001: OE Type Radiator Cap .....	10248	15
			2002-2001: OE Equivalent Fuel Cap .....	10834	
			2002-2001: Regular Locking Fuel Cap .....	10504	
			2002-2001: Oil Filler Cap .....	10114	

## Caps for Passenger Cars and Light Trucks (1990 and Newer)

Application	Part Number	PSI	Application	Part Number	PSI
<b>GMC - Continued</b>			<b>GMC - Continued</b>		
<b>Sonoma</b>			<b>Suburban - Continued</b>		
<b>4-Cyl. 2.2 L</b>			<b>V-8 6.5 L Diesel - Continued</b>		
2003-1998; Lev-R-Vent Radiator Cap .....	10330	16	1997; Oil Filler Cap; W/O Metal Oil Cap .....	10099	
2003-1998; OE Type Radiator Cap .....	10230	16	1996-1995; Lev-R-Vent Radiator Cap .....	10330	16
2003-1998; OE Equivalent Fuel Cap .....	10836		1996-1995; OE Type Radiator Cap .....	10230	16
2003-1998; Regular Locking Fuel Cap .....	10506		1996-1995; OE Equivalent Fuel Cap .....	10817	
2003-1998; Oil Filler Cap .....	10125		1996-1995; Diesel Regular Non-Locking Fuel Cap .....	10830D	
1997-1996; Lev-R-Vent Radiator Cap .....	10330	16	1996-1995; Regular Locking Fuel Cap .....	10591	
1997-1996; OE Type Radiator Cap .....	10230	16	1996-1995; Diesel Regular Locking Fuel Cap .....	10591D	
1997-1996; OE Equivalent Fuel Cap .....	10836		1996-1995; Pre-Vent Non-Locking Fuel Cap .....	10819	
1997-1996; Regular Locking Fuel Cap .....	10506		1996-1995; Diesel Pre-Vent Non-Locking Fuel Cap .....	10819D	
1997-1996; Oil Filler Cap .....	10128		1996-1995; Pre-Vent Locking Fuel Cap .....	10501	
1995; Lev-R-Vent Radiator Cap .....	10331	16	1996-1995; Diesel Only Pre-Vent Locking Fuel Cap .....	10501D	
1995; OE Type Radiator Cap .....	10231	16	1996-1995; Oil Filler Cap .....	10066	
1995; OE Equivalent Fuel Cap .....	10817				
1995; Pre-Vent Non-Locking Fuel Cap .....	10819		<b>V-8 7.4 L</b>		
1995; Regular Locking Fuel Cap .....	10591		1999; OE Type Radiator Cap .....	10248	15
1995; Pre-Vent Locking Fuel Cap .....	10501		1999; OE Equivalent Fuel Cap .....	10834	
1995; Oil Filler Cap .....	10128		1999; Regular Locking Fuel Cap .....	10504	
			1999; Oil Filler Cap .....	10114	
<b>V-6 4.3 L</b>			1998; Lev-R-Vent Radiator Cap .....	10331	16
2004-1996; Lev-R-Vent Radiator Cap .....	10330	16	1998; OE Type Radiator Cap .....	10231	16
2004-1996; OE Type Radiator Cap .....	10230	16	1998; OE Equivalent Fuel Cap .....	10834	
2004-1996; OE Equivalent Fuel Cap .....	10836		1998; Regular Locking Fuel Cap .....	10504	
2004-1996; Regular Locking Fuel Cap .....	10506		1998; Oil Filler Cap .....	10114	
2004-1996; Oil Filler Cap .....	10099		1997-1996; Lev-R-Vent Radiator Cap .....	10331	16
1995; Lev-R-Vent Radiator Cap .....	10331	16	1997-1996; OE Type Radiator Cap .....	10231	16
1995; OE Type Radiator Cap .....	10231	16	1997-1996; OE Equivalent Fuel Cap .....	10817	
1995; OE Equivalent Fuel Cap .....	10817		1997-1996; Pre-Vent Non-Locking Fuel Cap .....	10819	
1995; Pre-Vent Non-Locking Fuel Cap .....	10819		1997-1996; Regular Locking Fuel Cap .....	10591	
1995; Regular Locking Fuel Cap .....	10591		1997-1996; Pre-Vent Locking Fuel Cap .....	10501	
1995; Pre-Vent Locking Fuel Cap .....	10501		1997-1996; Oil Filler Cap .....	10114	
1995; Oil Filler Cap .....	10099		1995; Lev-R-Vent Radiator Cap .....	10331	16
			1995; OE Type Radiator Cap .....	10231	16
<b>Suburban</b>			1995; OE Equivalent Fuel Cap .....	10817	
<b>V-8 5.7 L</b>			1995; Pre-Vent Non-Locking Fuel Cap .....	10819	
1999; OE Type Radiator Cap .....	10248	15	1995; Regular Locking Fuel Cap .....	10591	
1999; OE Equivalent Fuel Cap .....	10834		1995; Pre-Vent Locking Fuel Cap .....	10501	
1999; Regular Locking Fuel Cap .....	10504		1995; Oil Filler Cap .....	10105	
1999; Oil Filler Cap .....	10105				
1998; Lev-R-Vent Radiator Cap .....	10331	16	<b>Terrain</b>		
1998; OE Type Radiator Cap .....	10231	16	<b>4-Cyl. 2.4 L</b>		
1998; OE Equivalent Fuel Cap .....	10834		2011; OE Type Radiator Cap .....	10248	15
1998; Regular Locking Fuel Cap .....	10504		2011; OE Equivalent Fuel Cap .....	10834	
1998; Oil Filler Cap .....	10105		2011; Regular Locking Fuel Cap .....	10504	
1997-1995; Lev-R-Vent Radiator Cap .....	10331	16	2010; OE Type Radiator Cap .....	10248	15
1997-1995; OE Type Radiator Cap .....	10231	16	2010; OE Equivalent Fuel Cap .....	10834	
1997-1995; OE Equivalent Fuel Cap .....	10817		2010; Regular Locking Fuel Cap .....	10504	
1997-1995; Pre-Vent Non-Locking Fuel Cap .....	10819		2010; Oil Filler Cap .....	10099	
1997-1995; Regular Locking Fuel Cap .....	10591				
1997-1995; Pre-Vent Locking Fuel Cap .....	10501		<b>V-6 3.0 L</b>		
1997-1995; Oil Filler Cap .....	10105		2011; OE Equivalent Fuel Cap .....	10834	
<b>V-8 6.5 L Diesel</b>			2011; Regular Locking Fuel Cap .....	10504	
1999-1998; Lev-R-Vent Radiator Cap .....	10330	16	2011; Flex Fuel Regular Fuel Cap .....	10834Y	
1999-1998; OE Type Radiator Cap .....	10230	16	2011; Flex Fuel Regular Locking Fuel Cap .....	10504Y	
1999-1998; OE Equivalent Fuel Cap .....	10817		2010; OE Type Radiator Cap .....	10248	15
1999-1998; Diesel Regular Non-Locking Fuel Cap .....	10830D		2010; OE Equivalent Fuel Cap .....	10834	
1999-1998; Regular Locking Fuel Cap .....	10591		2010; Regular Locking Fuel Cap .....	10504	
1999-1998; Diesel Regular Locking Fuel Cap .....	10591D		2010; Oil Filler Cap .....	10099	
1999-1998; Pre-Vent Non-Locking Fuel Cap .....	10819				
1999-1998; Diesel Pre-Vent Non-Locking Fuel Cap .....	10819D		<b>Yukon</b>		
1999-1998; Pre-Vent Locking Fuel Cap .....	10501		<b>V-8 4.8 L</b>		
1999-1998; Diesel Only Pre-Vent Locking Fuel Cap .....	10501D		2009-2005; OE Type Radiator Cap .....	10248	15
1999-1998; Oil Filler Cap .....	10099		2009-2005; OE Equivalent Fuel Cap .....	10841	
1997; Lev-R-Vent Radiator Cap .....	10330	16	2009-2005; Regular Locking Fuel Cap .....	10511	
1997; OE Type Radiator Cap .....	10230	16	2009-2005; Oil Filler Cap .....	10099	
1997; OE Equivalent Fuel Cap .....	10817		2004; OE Type Radiator Cap .....	10248	15
1997; Diesel Regular Non-Locking Fuel Cap .....	10830D		2004; OE Equivalent Fuel Cap; W/O Threaded Filler Neck .....	10841	
1997; Regular Locking Fuel Cap .....	10591		2004; Regular Locking Fuel Cap; W/O Threaded Filler Neck .....	10511	
1997; Diesel Regular Locking Fuel Cap .....	10591D		2004; OE Equivalent Fuel Cap; W/Threaded Filler Neck .....	10834	
1997; Pre-Vent Non-Locking Fuel Cap .....	10819		2004; Regular Locking Fuel Cap; W/Threaded Filler Neck .....	10504	
1997; Diesel Pre-Vent Non-Locking Fuel Cap .....	10819D		2004; Oil Filler Cap .....	10099	
1997; Pre-Vent Locking Fuel Cap .....	10501		2003-2000; OE Type Radiator Cap .....	10248	15
1997; Diesel Only Pre-Vent Locking Fuel Cap .....	10501D		2003-2000; OE Equivalent Fuel Cap .....	10834	
1997; Oil Filler Cap; W/Metal Oil Cap .....	10066		2003-2000; Regular Locking Fuel Cap .....	10504	
			2003-2000; Oil Filler Cap .....	10099	



## Caps for Passenger Cars and Light Trucks (1990 and Newer)

Application	Part Number	PSI	Application	Part Number	PSI
<b>GMC - Continued</b>			<b>GMC - Continued</b>		
<b>Yukon - Continued</b>			<b>Yukon - Continued</b>		
<b>V-8 5.3 L</b>			<b>V-8 6.0 L - Continued</b>		
2011; OE Equivalent Fuel Cap .....	10841		2004; Regular Locking Fuel Cap; W/Threaded Filler Neck .....	10504	
2011; Regular Locking Fuel Cap .....	10511		2004; Oil Filler Cap .....	10099	
2011; Flex Fuel Regular Fuel Cap .....	10841Y		2003-2000; OE Type Radiator Cap .....	10248	15
2011; Flex Fuel Regular Locking Fuel Cap .....	10511Y		2003-2000; OE Equivalent Fuel Cap .....	10834	
2011; Oil Filler Cap .....	10099		2003-2000; Regular Locking Fuel Cap .....	10504	
2010-2008; OE Type Radiator Cap .....	10248	15	2003-2000; Oil Filler Cap .....	10099	
2010-2008; OE Equivalent Fuel Cap .....	10841		<b>V-8 6.0 L Electric Assist</b>		
2010-2008; Regular Locking Fuel Cap .....	10511		2010-2008; OE Type Radiator Cap .....	10248	15
2010-2008; Flex Fuel Regular Fuel Cap .....	10841Y		2010-2008; OE Equivalent Fuel Cap .....	10841	
2010-2008; Flex Fuel Regular Locking Fuel Cap .....	10511Y		2010-2008; Regular Locking Fuel Cap .....	10511	
2010-2008; Oil Filler Cap .....	10099		2010-2008; Oil Filler Cap .....	10099	
2007-2005; OE Type Radiator Cap .....	10248	15	<b>V-8 6.2 L</b>		
2007-2005; OE Equivalent Fuel Cap .....	10841		2011; OE Equivalent Fuel Cap .....	10841	
2007-2005; Flex Fuel Regular Fuel Cap .....	10841Y		2011; Regular Locking Fuel Cap .....	10511	
2007-2005; Regular Locking Fuel Cap .....	10511		2011; Flex Fuel Regular Fuel Cap .....	10841Y	
2007-2005; Flex Fuel Regular Locking Fuel Cap .....	10511Y		2011; Flex Fuel Regular Locking Fuel Cap .....	10511Y	
2007-2005; Oil Filler Cap .....	10099		2011; Oil Filler Cap .....	10099	
2004; OE Type Radiator Cap .....	10248	15	2010; OE Type Radiator Cap .....	10248	15
2004; OE Equivalent Fuel Cap; W/O Threaded Filler Neck .....	10841		2010; OE Equivalent Fuel Cap .....	10841	
2004; Flex Fuel Regular Fuel Cap; W/O Threaded Filler Neck ...	10841Y		2010; Regular Locking Fuel Cap .....	10511	
2004; Regular Locking Fuel Cap; W/O Threaded Filler Neck .....	10511		2010; Flex Fuel Regular Fuel Cap .....	10841Y	
2004; Flex Fuel Regular Locking Fuel Cap; W/O Threaded Filler Neck .....	10511Y		2010; Flex Fuel Regular Locking Fuel Cap .....	10511Y	
2004; OE Equivalent Fuel Cap; W/Threaded Filler Neck .....	10834		2010; Oil Filler Cap .....	10099	
2004; Flex Fuel Regular Fuel Cap; W/Threaded Filler Neck .....	10834Y		2009-2007; OE Type Radiator Cap .....	10248	15
2004; Regular Locking Fuel Cap; W/Threaded Filler Neck .....	10504		2009-2007; OE Equivalent Fuel Cap .....	10841	
2004; Flex Fuel Regular Locking Fuel Cap; W/Threaded Filler Neck .....	10504Y		2009-2007; Regular Locking Fuel Cap .....	10511	
2004; Oil Filler Cap .....	10099		2009-2007; Oil Filler Cap .....	10099	
2003-2002; OE Type Radiator Cap .....	10248	15	<b>V-8 6.5 L Diesel</b>		
2003-2002; OE Equivalent Fuel Cap .....	10834		1997; Lev-R-Vent Radiator Cap .....	10330	16
2003-2002; Flex Fuel Regular Fuel Cap .....	10834Y		1997; OE Type Radiator Cap .....	10230	16
2003-2002; Regular Locking Fuel Cap .....	10504		1997; OE Equivalent Fuel Cap .....	10830	
2003-2002; Flex Fuel Regular Locking Fuel Cap .....	10504Y		1997; Diesel Regular Non-Locking Fuel Cap .....	10830D	
2003-2002; Oil Filler Cap .....	10099		1997; Regular Locking Fuel Cap .....	10591	
2001-2000; OE Type Radiator Cap .....	10248	15	1997; Diesel Regular Locking Fuel Cap .....	10591D	
2001-2000; OE Equivalent Fuel Cap .....	10834		1997; Diesel Pre-Vent Non-Locking Fuel Cap .....	10819D	
2001-2000; Regular Locking Fuel Cap .....	10504		1997; Diesel Only Pre-Vent Locking Fuel Cap .....	10501D	
2001-2000; Oil Filler Cap .....	10099		1997; Oil Filler Cap; W/Metal Oil Cap .....	10066	
<b>V-8 5.7 L</b>			1997; Oil Filler Cap; W/O Metal Oil Cap .....	10099	
2000-1998; Lev-R-Vent Radiator Cap .....	10331	16	1996; Lev-R-Vent Radiator Cap .....	10330	16
2000-1998; OE Type Radiator Cap .....	10231	16	1996; OE Type Radiator Cap .....	10230	16
2000-1998; OE Equivalent Fuel Cap .....	10834		1996; OE Equivalent Fuel Cap .....	10830	
2000-1998; Regular Locking Fuel Cap .....	10504		1996; Diesel Pre-Vent Non-Locking Fuel Cap .....	10819D	
2000-1998; Oil Filler Cap .....	10105		1996; Diesel Regular Non-Locking Fuel Cap .....	10830D	
1997-1995; Lev-R-Vent Radiator Cap .....	10331	16	1996; Regular Locking Fuel Cap .....	10591	
1997-1995; OE Type Radiator Cap .....	10231	16	1996; Diesel Only Pre-Vent Locking Fuel Cap .....	10501D	
1997-1995; OE Equivalent Fuel Cap .....	10817		1996; Diesel Regular Locking Fuel Cap .....	10591D	
1997-1995; Pre-Vent Non-Locking Fuel Cap .....	10819		1996; Oil Filler Cap .....	10066	
1997-1995; Regular Locking Fuel Cap .....	10591		1995; Lev-R-Vent Radiator Cap .....	10330	16
1997-1995; Pre-Vent Locking Fuel Cap .....	10501		1995; OE Type Radiator Cap .....	10230	16
1997-1995; Oil Filler Cap .....	10105		1995; OE Equivalent Fuel Cap .....	10817	
<b>V-8 6.0 L</b>			1995; Diesel Regular Non-Locking Fuel Cap .....	10830D	
2011; OE Equivalent Fuel Cap .....	10841		1995; Regular Locking Fuel Cap .....	10591	
2011; Regular Locking Fuel Cap .....	10511		1995; Diesel Regular Locking Fuel Cap .....	10591D	
2011; Flex Fuel Regular Fuel Cap .....	10841Y		1995; Pre-Vent Non-Locking Fuel Cap .....	10819	
2011; Flex Fuel Regular Locking Fuel Cap .....	10511Y		1995; Diesel Pre-Vent Non-Locking Fuel Cap .....	10819D	
2011; Oil Filler Cap .....	10099		1995; Pre-Vent Locking Fuel Cap .....	10501	
2010; OE Type Radiator Cap .....	10248	15	1995; Diesel Only Pre-Vent Locking Fuel Cap .....	10501D	
2010; OE Equivalent Fuel Cap .....	10841		1995; Oil Filler Cap .....	10066	
2010; Regular Locking Fuel Cap .....	10511		<b>V-8 8.1 L</b>		
2010; Flex Fuel Regular Fuel Cap .....	10841Y		2006-2005; OE Type Radiator Cap .....	10248	15
2010; Flex Fuel Regular Locking Fuel Cap .....	10511Y		2006-2005; OE Equivalent Fuel Cap .....	10841	
2010; Oil Filler Cap .....	10099		2006-2005; Regular Locking Fuel Cap .....	10511	
2009-2005; OE Type Radiator Cap .....	10248	15	2006-2005; Oil Filler Cap .....	10099	
2009-2005; OE Equivalent Fuel Cap .....	10841		2004; OE Type Radiator Cap .....	10248	15
2009-2005; Regular Locking Fuel Cap .....	10511		2004; OE Equivalent Fuel Cap; W/O Threaded Filler Neck .....	10841	
2009-2005; Oil Filler Cap .....	10099		2004; Regular Locking Fuel Cap; W/O Threaded Filler Neck .....	10511	
2004; OE Type Radiator Cap .....	10248	15	2004; OE Equivalent Fuel Cap; W/Threaded Filler Neck .....	10834	
2004; OE Equivalent Fuel Cap; W/O Threaded Filler Neck .....	10841		2004; Regular Locking Fuel Cap; W/Threaded Filler Neck .....	10504	
2004; Regular Locking Fuel Cap; W/O Threaded Filler Neck .....	10511		2004; Oil Filler Cap .....	10099	
2004; OE Equivalent Fuel Cap; W/Threaded Filler Neck .....	10834		2003; OE Type Radiator Cap .....	10248	15
			2003; OE Equivalent Fuel Cap .....	10834	
			2003; Regular Locking Fuel Cap .....	10504	

## Caps for Passenger Cars and Light Trucks (1990 and Newer)

Application	Part Number	PSI	Application	Part Number	PSI
<b>GMC - Continued</b>			<b>Honda - Continued</b>		
<b>Yukon - Continued</b>			<b>Accord - Continued</b>		
<b>V-8 8.1 L - Continued</b>			<b>V-6 3.0 L - Continued</b>		
2003: Oil Filler Cap .....	10099		2004: OE Type Radiator Cap .....	10242	16
2002-2001: OE Type Radiator Cap .....	10248	15	2004: OE Equivalent Fuel Cap .....	10834	
2002-2001: OE Equivalent Fuel Cap .....	10834		2004: Regular Locking Fuel Cap .....	10504	
2002-2001: Regular Locking Fuel Cap .....	10504		2004: Oil Filler Cap .....	10134	
2002-2001: Oil Filler Cap .....	10114		2003-1998: OE Type Radiator Cap .....	10242	16
<b>Honda</b>			2003-1998: OE Equivalent Fuel Cap .....	10834	
<b>Accord</b>			2003-1998: Regular Locking Fuel Cap .....	10504	
<b>4-Cyl. 2.2 L</b>			2003-1998: Oil Filler Cap .....	10081	
1997: OE Type Radiator Cap .....	10242	16	<b>V-6 3.0 L Electric Assist</b>		
1997: OE Equivalent Fuel Cap .....	10834		2007: OE Type Radiator Cap .....	10242	16
1997: Regular Locking Fuel Cap .....	10504		2007: OE Equivalent Fuel Cap .....	10837	
1997: Oil Filler Cap .....	10081		2007: Regular Locking Fuel Cap .....	10507	
1996-1995: Lev-R-Vent Radiator Cap; W/Toyo Rad. ....	✓10333	16	2007: Oil Filler Cap .....	10134	
1996-1995: OE Type Radiator Cap; W/Toyo Rad. ....	10233	16	2006: Oil Filler Cap .....	10134	
1996-1995: OE Type Radiator Cap; W/O Toyo Rad. ....	10242	16	2005: OE Type Radiator Cap .....	10242	16
1996-1995: OE Equivalent Fuel Cap .....	10834		2005: Oil Filler Cap .....	10134	
1996-1995: Regular Locking Fuel Cap .....	10504		<b>V-6 3.5 L</b>		
1996-1995: Oil Filler Cap .....	10081		2011: OE Type Radiator Cap .....	10242	16
<b>4-Cyl. 2.3 L</b>			2011: OE Equivalent Fuel Cap .....	10837	
2002-2000: OE Type Radiator Cap; W/Nippondenso Rad. ....	10242	16	2011: Regular Locking Fuel Cap .....	10507	
2002-2000: Lev-R-Vent Radiator Cap; W/Valeo Rad. ....	✓10333	16	2010-2008: OE Type Radiator Cap .....	10242	16
2002-2000: OE Type Radiator Cap; W/Valeo Rad. ....	10233	16	2010-2008: OE Equivalent Fuel Cap .....	10837	
2002-2000: OE Equivalent Fuel Cap .....	10834		2010-2008: Regular Locking Fuel Cap .....	10507	
2002-2000: Regular Locking Fuel Cap .....	10504		2010-2008: Oil Filler Cap .....	10134	
2002-2000: Oil Filler Cap .....	10081		<b>Civic</b>		
1999-1998: OE Type Radiator Cap; W/Auto. Trans. ....	10242	16	<b>4-Cyl. 1.3 L Electric Assist</b>		
1999-1998: Lev-R-Vent Radiator Cap; W/Man. Trans. ....	✓10333	16	2011: OE Type Radiator Cap .....	10242	16
1999-1998: OE Type Radiator Cap; W/Man. Trans. ....	10233	16	2011: OE Equivalent Fuel Cap .....	10837	
1999-1998: OE Equivalent Fuel Cap .....	10834		2011: Regular Locking Fuel Cap .....	10507	
1999-1998: Regular Locking Fuel Cap .....	10504		2010-2006: OE Type Radiator Cap .....	10242	16
1999-1998: Oil Filler Cap .....	10081		2010-2006: OE Equivalent Fuel Cap .....	10837	
<b>4-Cyl. 2.4 L</b>			2010-2006: Regular Locking Fuel Cap .....	10507	
2011: OE Type Radiator Cap .....	10242	16	2010-2006: Oil Filler Cap .....	10134	
2011: OE Equivalent Fuel Cap .....	10837		2005-2003: OE Type Radiator Cap .....	10242	16
2011: Regular Locking Fuel Cap .....	10507		2005-2003: OE Equivalent Fuel Cap .....	10834	
2010: OE Type Radiator Cap .....	10242	16	2005-2003: Regular Locking Fuel Cap .....	10504	
2010: OE Equivalent Fuel Cap .....	10837		2005-2003: Oil Filler Cap .....	10134	
2010: Regular Locking Fuel Cap .....	10507		<b>4-Cyl. 1.5 L</b>		
2010: Oil Filler Cap .....	10134		1995: OE Type Radiator Cap .....	10242	16
2009-2008: OE Type Radiator Cap .....	10242	16	1995: OE Equivalent Fuel Cap .....	10834	
2009-2008: OE Equivalent Fuel Cap .....	10837		1995: Regular Locking Fuel Cap .....	10504	
2009-2008: Regular Locking Fuel Cap .....	10507		1995: Oil Filler Cap .....	10081	
2007-2005: OE Type Radiator Cap; W/Nippondenso Rad. ....	10242	16	<b>4-Cyl. 1.6 L</b>		
2007-2005: Lev-R-Vent Radiator Cap; W/Valeo Rad. ....	✓10333	16	2000-1995: OE Type Radiator Cap .....	10242	16
2007-2005: OE Type Radiator Cap; W/Valeo Rad. ....	10233	16	2000-1995: OE Equivalent Fuel Cap .....	10834	
2007-2005: OE Equivalent Fuel Cap .....	10837		2000-1995: Regular Locking Fuel Cap .....	10504	
2007-2005: Regular Locking Fuel Cap .....	10507		2000-1995: Oil Filler Cap .....	10081	
2007-2005: Oil Filler Cap .....	10134		<b>4-Cyl. 1.7 L</b>		
2004-2003: OE Type Radiator Cap; W/Nippondenso Rad. ....	10242	16	2005-2003: OE Type Radiator Cap .....	10242	16
2004-2003: Lev-R-Vent Radiator Cap; W/Valeo Rad. ....	✓10333	16	2005-2003: OE Equivalent Fuel Cap .....	10834	
2004-2003: OE Type Radiator Cap; W/Valeo Rad. ....	10233	16	2005-2003: Regular Locking Fuel Cap .....	10504	
2004-2003: OE Equivalent Fuel Cap .....	10834		2005-2003: Oil Filler Cap .....	10134	
2004-2003: Regular Locking Fuel Cap .....	10504		2002-2001: OE Type Radiator Cap .....	10242	16
2004-2003: Oil Filler Cap .....	10134		2002-2001: OE Equivalent Fuel Cap .....	10834	
<b>V-6 2.7 L</b>			2002-2001: Regular Locking Fuel Cap .....	10504	
1997-1995: OE Type Radiator Cap .....	10242	16	2002-2001: Oil Filler Cap .....	10081	
1997-1995: OE Equivalent Fuel Cap .....	10834		<b>4-Cyl. 1.8 L</b>		
1997-1995: Regular Locking Fuel Cap .....	10504		2011-2006: OE Type Radiator Cap .....	10242	16
1997-1995: Oil Filler Cap .....	10081		2011-2006: OE Equivalent Fuel Cap .....	10837	
<b>V-6 3.0 L</b>			2011-2006: Regular Locking Fuel Cap .....	10507	
2007: OE Type Radiator Cap; W/Nippondenso Rad. ....	10242	16	2011-2006: Oil Filler Cap .....	10134	
2007: Lev-R-Vent Radiator Cap; W/Valeo Rad. ....	✓10333	16	<b>4-Cyl. 2.0 L</b>		
2007: OE Type Radiator Cap; W/Valeo Rad. ....	10233	16	2011-2006: OE Type Radiator Cap .....	10242	16
2007: OE Equivalent Fuel Cap .....	10837		2011-2006: OE Equivalent Fuel Cap .....	10837	
2007: Regular Locking Fuel Cap .....	10507		2011-2006: Regular Locking Fuel Cap .....	10507	
2007: Oil Filler Cap .....	10134		2011-2006: Oil Filler Cap .....	10134	
2006-2005: OE Type Radiator Cap .....	10242	16	2005-2002: OE Type Radiator Cap .....	10242	16
2006-2005: OE Equivalent Fuel Cap .....	10837		2005-2002: OE Equivalent Fuel Cap .....	10834	
2006-2005: Regular Locking Fuel Cap .....	10507		2005-2002: Regular Locking Fuel Cap .....	10504	
2006-2005: Oil Filler Cap .....	10134		2005-2002: Oil Filler Cap .....	10134	

✓ Check Hood Clearance prior to installing this Cap.

## Caps for Passenger Cars and Light Trucks (1990 and Newer)

Application	Part Number	PSI	Application	Part Number	PSI
<b>Honda - Continued</b>			<b>Honda - Continued</b>		
<b>Civic Del Sol</b>			<b>Insight</b>		
<b>4-Cyl. 1.5 L</b>			<b>3-Cyl. 1.0 L Electric Assist</b>		
1995: OE Type Radiator Cap .....	10242	16	2006-2000: OE Type Radiator Cap .....	10242	16
1995: OE Equivalent Fuel Cap .....	10834		2006-2000: OE Equivalent Fuel Cap .....	10834	
1995: Regular Locking Fuel Cap .....	10504		2006-2000: Regular Locking Fuel Cap .....	10504	
1995: Oil Filler Cap .....	10081		2006-2000: Oil Filler Cap .....	10134	
<b>4-Cyl. 1.6 L</b>			<b>4-Cyl. 1.3 L Electric Assist</b>		
1997-1995: OE Type Radiator Cap .....	10242	16	2011-2010: OE Type Radiator Cap .....	10242	16
1997-1995: OE Equivalent Fuel Cap .....	10834		2011-2010: OE Equivalent Fuel Cap .....	10837	
1997-1995: Regular Locking Fuel Cap .....	10504		2011-2010: Regular Locking Fuel Cap .....	10507	
1997-1995: Oil Filler Cap .....	10081		2011-2010: Oil Filler Cap .....	10134	
<b>CR-V</b>			<b>Odyssey</b>		
<b>4-Cyl. 2.0 L</b>			<b>4-Cyl. 2.2 L</b>		
2001-1997: OE Type Radiator Cap .....	10242	16	1997-1995: OE Type Radiator Cap .....	10242	16
2001-1997: OE Equivalent Fuel Cap .....	10834		1997-1995: OE Equivalent Fuel Cap .....	10834	
2001-1997: Regular Locking Fuel Cap .....	10504		1997-1995: Regular Locking Fuel Cap .....	10504	
2001-1997: Oil Filler Cap .....	10081		1997-1995: Oil Filler Cap .....	10081	
<b>4-Cyl. 2.4 L</b>			<b>4-Cyl. 2.3 L</b>		
2011: OE Type Radiator Cap .....	10242	16	1998: OE Type Radiator Cap .....	10242	16
2011: OE Equivalent Fuel Cap .....	10837		1998: OE Equivalent Fuel Cap .....	10834	
2011: Regular Locking Fuel Cap .....	10507		1998: Regular Locking Fuel Cap .....	10504	
2010: OE Type Radiator Cap .....	10242	16	1998: Oil Filler Cap .....	10081	
2010: OE Equivalent Fuel Cap .....	10837		<b>V-6 3.5 L</b>		
2010: Regular Locking Fuel Cap .....	10507		2011: OE Type Radiator Cap .....	10242	16
2010: Oil Filler Cap .....	10134		2011: OE Equivalent Fuel Cap .....	10837	
2009: OE Type Radiator Cap .....	10242	16	2011: Regular Locking Fuel Cap .....	10507	
2009: OE Equivalent Fuel Cap .....	10837		2010-2005: OE Type Radiator Cap .....	10242	16
2009: Regular Locking Fuel Cap .....	10507		2010-2005: OE Equivalent Fuel Cap .....	10837	
2008-2005: OE Type Radiator Cap .....	10242	16	2010-2005: Regular Locking Fuel Cap .....	10507	
2008-2005: OE Equivalent Fuel Cap .....	10837		2010-2005: Oil Filler Cap .....	10134	
2008-2005: Regular Locking Fuel Cap .....	10507		2004-2001: OE Type Radiator Cap .....	10242	16
2008-2005: Oil Filler Cap .....	10134		2004-2001: OE Equivalent Fuel Cap .....	10834	
2004-2002: OE Type Radiator Cap .....	10242	16	2004-2001: Regular Locking Fuel Cap .....	10504	
2004-2002: OE Equivalent Fuel Cap .....	10834		2004-2001: Oil Filler Cap .....	10134	
2004-2002: Regular Locking Fuel Cap .....	10504		2000-1999: OE Type Radiator Cap .....	10242	16
2004-2002: Oil Filler Cap .....	10134		2000-1999: OE Equivalent Fuel Cap .....	10834	
<b>CR-Z</b>			<b>2000-1999: Regular Locking Fuel Cap .....</b>		
<b>4-Cyl. 1.5 L Electric Assist</b>			<b>2000-1999: Oil Filler Cap .....</b>		
2011: OE Type Radiator Cap .....	10242	16	<b>Passport</b>		
2011: OE Equivalent Fuel Cap .....	10837		<b>4-Cyl. 2.6 L</b>		
2011: Regular Locking Fuel Cap .....	10507		1996-1995: Lev-R-Vent Radiator Cap .....	✓10333	16
<b>Element</b>			1996-1995: OE Type Radiator Cap .....	10233	16
<b>4-Cyl. 2.4 L</b>			1996-1995: OE Equivalent Fuel Cap .....	10834	
2011: OE Type Radiator Cap .....	10242	16	1996-1995: Regular Locking Fuel Cap .....	10504	
2011: OE Equivalent Fuel Cap .....	10837		1996-1995: Oil Filler Cap .....	10101	
2011: Regular Locking Fuel Cap .....	10507		<b>V-6 3.2 L</b>		
2010: OE Type Radiator Cap .....	10242	16	2002-2001: Lev-R-Vent Radiator Cap .....	✓10333	16
2010: OE Equivalent Fuel Cap .....	10837		2002-2001: OE Type Radiator Cap .....	10233	16
2010: Regular Locking Fuel Cap .....	10507		2002-2001: OE Equivalent Fuel Cap .....	10834	
2010: Oil Filler Cap .....	10134		2002-2001: Regular Locking Fuel Cap .....	10504	
2009: OE Type Radiator Cap .....	10242	16	2002-2001: Oil Filler Cap .....	10101	
2009: OE Equivalent Fuel Cap .....	10837		2000-1999: Lev-R-Vent Radiator Cap .....	✓10333	16
2009: Regular Locking Fuel Cap .....	10507		2000-1999: OE Type Radiator Cap .....	10233	16
2008-2006: OE Type Radiator Cap .....	10242	16	2000-1999: OE Equivalent Fuel Cap .....	10834	
2008-2006: OE Equivalent Fuel Cap .....	10837		2000-1999: Regular Locking Fuel Cap .....	10504	
2008-2006: Regular Locking Fuel Cap .....	10507		2000-1999: Oil Filler Cap .....	10081	
2008-2006: Oil Filler Cap .....	10134		1998-1996: Lev-R-Vent Radiator Cap .....	✓10333	16
2005-2003: OE Type Radiator Cap .....	10242	16	1998-1996: OE Type Radiator Cap .....	10233	16
2005-2003: OE Equivalent Fuel Cap .....	10834		1998-1996: OE Equivalent Fuel Cap .....	10834	
2005-2003: Regular Locking Fuel Cap .....	10504		1998-1996: Regular Locking Fuel Cap .....	10504	
2005-2003: Oil Filler Cap .....	10134		1998-1996: Oil Filler Cap .....	10101	
<b>Fit</b>			1995: Lev-R-Vent Radiator Cap .....	✓10333	16
<b>4-Cyl. 1.5 L</b>			1995: OE Type Radiator Cap .....	10233	16
2011-2009: OE Type Radiator Cap .....	10242	16	1995: OE Equivalent Fuel Cap .....	10834	
2011-2009: OE Equivalent Fuel Cap .....	10837		1995: Regular Locking Fuel Cap .....	10504	
2011-2009: Regular Locking Fuel Cap .....	10507		1995: Oil Filler Cap .....	10134	
2011-2009: Oil Filler Cap .....	10134		<b>Pilot</b>		
2008-2007: OE Type Radiator Cap .....	10242	16	<b>V-6 3.5 L</b>		
2008-2007: OE Equivalent Fuel Cap .....	10837		2011-2005: OE Type Radiator Cap .....	10242	16
2008-2007: Oil Filler Cap .....	10134		2011-2005: OE Equivalent Fuel Cap .....	10837	
			2011-2005: Regular Locking Fuel Cap .....	10507	

✓ Check Hood Clearance prior to installing this Cap.

## Caps for Passenger Cars and Light Trucks (1990 and Newer)

Application	Part Number	PSI	Application	Part Number	PSI
<b>Honda - Continued</b>			<b>Hummer - Continued</b>		
<b>Pilot - Continued</b>			<b>H1 - Continued</b>		
<b>V-6 3.5 L - Continued</b>			<b>V-8 6.5 L Diesel - Continued</b>		
2011-2005: Oil Filler Cap .....	10134		2004: Oil Filler Cap .....	10099	
2004-2003: OE Type Radiator Cap .....	10242	16	2003-2002: Lev-R-Vent Radiator Cap .....	10330	16
2004-2003: OE Equivalent Fuel Cap .....	10834		2003-2002: OE Type Radiator Cap .....	10230	16
2004-2003: Regular Locking Fuel Cap .....	10504		2003-2002: OE Equivalent Fuel Cap .....	10826	
2004-2003: Oil Filler Cap .....	10134		2003-2002: Regular Locking Fuel Cap .....	10596	
<b>Prelude</b>			2003-2002: Oil Filler Cap .....		
<b>4-Cyl. 2.2 L</b>			2003-2002: Oil Filler Cap .....		
2001-1997: OE Type Radiator Cap; W/Nippondenso Rad. ....	10242	16	<b>V-8 6.6 L Diesel</b>		
2001-1997: Lev-R-Vent Radiator Cap; W/Toyo Rad. ....	✓10333	16	2006: Lev-R-Vent Radiator Cap .....	10330	16
2001-1997: OE Type Radiator Cap; W/Toyo Rad. ....	10233	16	2006: OE Type Radiator Cap .....	10230	16
2001-1997: OE Equivalent Fuel Cap .....	10834		2006: OE Equivalent Fuel Cap .....	10826	
2001-1997: Regular Locking Fuel Cap .....	10504		2006: Regular Locking Fuel Cap .....	10596	
2001-1997: Oil Filler Cap .....	10081		2006: Oil Filler Cap .....	10099	
1996: OE Type Radiator Cap; W/VTEC Eng. ....	10242	16	<b>H2</b>		
1996: Lev-R-Vent Radiator Cap; W/O VTEC Eng. ....	✓10333	16	<b>V-8 6.0 L</b>		
1996: OE Type Radiator Cap; W/O VTEC Eng. ....	10233	16	2007-2005: OE Type Radiator Cap .....	10248	15
1996: OE Equivalent Fuel Cap .....	10834		2007-2005: OE Equivalent Fuel Cap .....	10841	
1996: Regular Locking Fuel Cap .....	10504		2007-2005: Regular Locking Fuel Cap .....	10511	
1996: Oil Filler Cap .....	10081		2007-2005: Oil Filler Cap .....	10099	
1995: OE Type Radiator Cap; W/VTEC Eng.; W/Nippondenso Rad. ....	10242	16	2004: OE Type Radiator Cap .....	10248	15
1995: Lev-R-Vent Radiator Cap; W/VTEC Eng.; W/Toyo Rad. ....	✓10333	16	2004: OE Equivalent Fuel Cap; W/O Threaded Filler Neck .....	10841	
1995: OE Type Radiator Cap; W/VTEC Eng.; W/Toyo Rad. ....	10233	16	2004: Regular Locking Fuel Cap; W/O Threaded Filler Neck .....	10511	
1995: Lev-R-Vent Radiator Cap; W/O VTEC Eng. ....	✓10333	16	2004: OE Equivalent Fuel Cap; W/Threaded Filler Neck .....	10834	
1995: OE Type Radiator Cap; W/O VTEC Eng. ....	10233	16	2004: Regular Locking Fuel Cap; W/Threaded Filler Neck .....	10504	
1995: OE Equivalent Fuel Cap .....	10834		2004: Oil Filler Cap .....	10099	
1995: Regular Locking Fuel Cap .....	10504		2003: OE Type Radiator Cap .....	10248	15
1995: Oil Filler Cap .....	10081		2003: OE Equivalent Fuel Cap .....	10834	
<b>4-Cyl. 2.3 L</b>			2003: Regular Locking Fuel Cap .....		
1996: OE Type Radiator Cap .....	10242	16	2003: Oil Filler Cap .....		
1996: OE Equivalent Fuel Cap .....	10834		<b>V-8 6.2 L</b>		
1996: Regular Locking Fuel Cap .....	10504		2009-2008: OE Type Radiator Cap .....	10248	15
1996: Oil Filler Cap .....	10081		2009-2008: OE Equivalent Fuel Cap .....	10841	
1995: OE Type Radiator Cap; W/Nippondenso Rad. ....	10242	16	2009-2008: Regular Locking Fuel Cap .....	10511	
1995: Lev-R-Vent Radiator Cap; W/Toyo Rad. ....	✓10333	16	2009-2008: Oil Filler Cap .....	10099	
1995: OE Type Radiator Cap; W/Toyo Rad. ....	10233	16	<b>H3</b>		
1995: OE Equivalent Fuel Cap .....	10834		<b>5-Cyl. 3.5 L</b>		
1995: Regular Locking Fuel Cap .....	10504		2006: OE Type Radiator Cap .....	10248	15
1995: Oil Filler Cap .....	10081		2006: OE Equivalent Fuel Cap .....	10841	
<b>Ridgeline</b>			2006: Regular Locking Fuel Cap .....	10511	
<b>V-6 3.5 L</b>			2006: Oil Filler Cap .....	10099	
2011: OE Type Radiator Cap .....	10242	16	<b>5-Cyl. 3.7 L</b>		
2011: OE Equivalent Fuel Cap .....	10837		2010: OE Type Radiator Cap .....	10248	15
2011: Regular Locking Fuel Cap .....	10507		2010: Oil Filler Cap .....	10099	
2010-2006: OE Type Radiator Cap .....	10242	16	2009-2007: OE Type Radiator Cap .....	10248	15
2010-2006: OE Equivalent Fuel Cap .....	10837		2009-2007: OE Equivalent Fuel Cap .....	10841	
2010-2006: Regular Locking Fuel Cap .....	10507		2009-2007: Regular Locking Fuel Cap .....	10511	
2010-2006: Oil Filler Cap .....	10134		2009-2007: Oil Filler Cap .....	10099	
<b>S2000</b>			<b>V-8 5.3 L</b>		
<b>4-Cyl. 2.0 L</b>			2010: OE Type Radiator Cap .....	10248	15
2003-2000: OE Type Radiator Cap .....	10242	16	2010: Oil Filler Cap .....	10099	
2003-2000: OE Equivalent Fuel Cap .....	10834		2009-2008: OE Type Radiator Cap .....	10248	15
2003-2000: Regular Locking Fuel Cap .....	10504		2009-2008: OE Equivalent Fuel Cap .....	10841	
2003-2000: Oil Filler Cap .....	10081		2009-2008: Regular Locking Fuel Cap .....	10511	
<b>4-Cyl. 2.2 L</b>			2009-2008: Oil Filler Cap .....	10099	
2009-2006: OE Type Radiator Cap .....	10242	16	<b>H3T</b>		
2009-2006: OE Equivalent Fuel Cap .....	10837		<b>5-Cyl. 3.7 L; V-8 5.3 L</b>		
2009-2006: Regular Locking Fuel Cap .....	10507		2010: OE Type Radiator Cap .....	10248	15
2009-2006: Oil Filler Cap .....	10081		2010: Oil Filler Cap .....	10099	
2005-2004: OE Type Radiator Cap .....	10242	16	2009: OE Type Radiator Cap .....	10248	15
2005-2004: OE Equivalent Fuel Cap .....	10834		2009: OE Equivalent Fuel Cap .....	10841	
2005-2004: Regular Locking Fuel Cap .....	10504		2009: Regular Locking Fuel Cap .....	10511	
2005-2004: Oil Filler Cap .....	10081		2009: Oil Filler Cap .....	10099	
<b>Hummer</b>			<b>Hyundai</b>		
<b>H1</b>			<b>Accent</b>		
<b>V-8 6.5 L Diesel</b>			<b>4-Cyl. 1.5 L</b>		
2004: OE Equivalent Fuel Cap .....	10826		2002-2000: Lev-R-Vent Radiator Cap .....	✓10327	13
2004: Regular Locking Fuel Cap .....	10596		2002-2000: OE Type Radiator Cap .....	10227	13
			2002-2000: OE Equivalent Fuel Cap .....	10825	

✓ Check Hood Clearance prior to installing this Cap.

## Caps for Passenger Cars and Light Trucks (1990 and Newer)

Application	Part Number	PSI	Application	Part Number	PSI
<b>Hyundai - Continued</b>			<b>Hyundai - Continued</b>		
<b>Accent - Continued</b>			<b>Azera - Continued</b>		
<b>4-Cyl. 1.5 L - Continued</b>			<b>V-6 3.8 L - Continued</b>		
2002-2000: Regular Locking Fuel Cap .....	10595		2009-2008: Regular Locking Fuel Cap .....	10512	
2002-2000: Oil Filler Cap .....	10081		2009-2008: Oil Filler Cap .....	10081	
1999-1995: Lev-R-Vent Radiator Cap .....	✓10327	13	2007: Lev-R-Vent Radiator Cap .....	10333	16
1999-1995: OE Type Radiator Cap .....	10227	13	2007: OE Type Radiator Cap .....	10233	16
1999-1995: OE Equivalent Fuel Cap .....	10825		2007: OE Equivalent Fuel Cap .....	10842	
1999-1995: Regular Locking Fuel Cap .....	10595		2007: Regular Locking Fuel Cap .....	10512	
1999-1995: Oil Filler Cap .....	10088		2007: Oil Filler Cap .....	10081	
<b>4-Cyl. 1.6 L</b>			2006: Lev-R-Vent Radiator Cap .....	✓10333	16
2011: OE Equivalent Fuel Cap .....	10842		2006: OE Type Radiator Cap .....	10233	16
2011: Regular Locking Fuel Cap .....	10512		2006: OE Equivalent Fuel Cap .....	10842	
2011: Oil Filler Cap .....	10081		2006: Regular Locking Fuel Cap .....	10512	
2010: Lev-R-Vent Radiator Cap .....	✓10327	13	2006: Oil Filler Cap .....	10081	
2010: OE Type Radiator Cap .....	10227	13	<b>Elantra</b>		
2010: OE Equivalent Fuel Cap .....	10842		<b>4-Cyl. 1.6 L</b>		
2010: Regular Locking Fuel Cap .....	10512		1995: Lev-R-Vent Radiator Cap .....	✓10327	13
2009: OE Equivalent Fuel Cap .....	10842		1995: OE Type Radiator Cap .....	10227	13
2009: Regular Locking Fuel Cap .....	10512		1995: OE Equivalent Fuel Cap .....	10825	
2009: Oil Filler Cap .....	10081		1995: Regular Locking Fuel Cap .....	10595	
2008: OE Type Radiator Cap .....	10242	16	1995: Oil Filler Cap .....	10088	
2008: OE Equivalent Fuel Cap .....	10842		<b>4-Cyl. 1.8 L</b>		
2008: Regular Locking Fuel Cap .....	10512		2011: Lev-R-Vent Radiator Cap .....	10333	16
2008: Oil Filler Cap .....	10081		2011: OE Type Radiator Cap .....	10233	16
2007: OE Equivalent Fuel Cap .....	10842		2011: OE Equivalent Fuel Cap .....	10842	
2007: Regular Locking Fuel Cap .....	10512		2011: Regular Locking Fuel Cap .....	10512	
2007: Oil Filler Cap .....	10081		2011: Oil Filler Cap .....	10081	
2006: Lev-R-Vent Radiator Cap .....	✓10327	13	1998-1996: Lev-R-Vent Radiator Cap .....	✓10327	13
2006: OE Type Radiator Cap .....	10227	13	1998-1996: OE Type Radiator Cap .....	10227	13
2006: OE Equivalent Fuel Cap .....	10842		1998-1996: OE Equivalent Fuel Cap .....	10825	
2006: Regular Locking Fuel Cap .....	10512		1998-1996: Regular Locking Fuel Cap .....	10595	
2006: Oil Filler Cap .....	10082		1998-1996: Oil Filler Cap .....	10138	
2005: Lev-R-Vent Radiator Cap .....	✓10327	13	1995: Lev-R-Vent Radiator Cap .....	✓10327	13
2005: OE Type Radiator Cap .....	10227	13	1995: OE Type Radiator Cap .....	10227	13
2005: OE Equivalent Fuel Cap .....	10842		1995: OE Equivalent Fuel Cap .....	10825	
2005: Regular Locking Fuel Cap .....	10512		1995: Regular Locking Fuel Cap .....	10595	
2005: Oil Filler Cap .....	10081		1995: Oil Filler Cap .....	10088	
2004-2001: Lev-R-Vent Radiator Cap .....	✓10327	13	<b>4-Cyl. 2.0 L</b>		
2004-2001: OE Type Radiator Cap .....	10227	13	2011: OE Equivalent Fuel Cap .....	10842	
2004-2001: OE Equivalent Fuel Cap .....	10825		2011: Regular Locking Fuel Cap .....	10512	
2004-2001: Regular Locking Fuel Cap .....	10595		2011: Oil Filler Cap .....	10081	
2004-2001: Oil Filler Cap .....	10081		2010: Lev-R-Vent Radiator Cap .....	10333	16
<b>Azera</b>			2010: OE Type Radiator Cap .....	10233	16
<b>V-6 3.3 L</b>			2010: OE Equivalent Fuel Cap .....	10842	
2011: OE Equivalent Fuel Cap .....	10842		2010: Regular Locking Fuel Cap .....	10512	
2011: Regular Locking Fuel Cap .....	10512		2010: Lev-R-Vent Radiator Cap .....	✓10333	16
2011: Oil Filler Cap .....	10081		2009-2008: OE Type Radiator Cap .....	10233	16
2010: Lev-R-Vent Radiator Cap .....	10333	16	2009-2008: OE Equivalent Fuel Cap .....	10842	
2010: OE Type Radiator Cap .....	10233	16	2009-2008: Regular Locking Fuel Cap .....	10512	
2010: OE Equivalent Fuel Cap .....	10842		2009-2008: Oil Filler Cap .....	10081	
2010: Regular Locking Fuel Cap .....	10512		2007: Lev-R-Vent Radiator Cap .....	10333	16
2009-2008: Lev-R-Vent Radiator Cap .....	✓10333	16	2007: OE Type Radiator Cap .....	10233	16
2009-2008: OE Type Radiator Cap .....	10233	16	2007: OE Equivalent Fuel Cap .....	10842	
2009-2008: OE Equivalent Fuel Cap .....	10842		2007: Regular Locking Fuel Cap .....	10512	
2009-2008: Regular Locking Fuel Cap .....	10512		2007: Oil Filler Cap .....	10081	
2009-2008: Oil Filler Cap .....	10081		2006-2004: Lev-R-Vent Radiator Cap .....	✓10333	16
2007: Lev-R-Vent Radiator Cap .....	10333	16	2006-2004: OE Type Radiator Cap .....	10233	16
2007: OE Type Radiator Cap .....	10233	16	2006-2004: OE Equivalent Fuel Cap .....	10842	
2007: OE Equivalent Fuel Cap .....	10842		2006-2004: Regular Locking Fuel Cap .....	10512	
2007: Regular Locking Fuel Cap .....	10512		2006-2004: Oil Filler Cap .....	10081	
2007: Oil Filler Cap .....	10081		2003-2001: Lev-R-Vent Radiator Cap .....	✓10333	16
<b>V-6 3.8 L</b>			2003-2001: OE Type Radiator Cap .....	10233	16
2011: OE Equivalent Fuel Cap .....	10842		2003-2001: OE Equivalent Fuel Cap .....	10825	
2011: Regular Locking Fuel Cap .....	10512		2003-2001: Regular Locking Fuel Cap .....	10595	
2011: Oil Filler Cap .....	10081		2003-2001: Oil Filler Cap .....	10081	
2010: Lev-R-Vent Radiator Cap .....	10333	16	2000-1999: Lev-R-Vent Radiator Cap .....	✓10327	13
2010: OE Type Radiator Cap .....	10233	16	2000-1999: OE Type Radiator Cap .....	10227	13
2010: OE Equivalent Fuel Cap .....	10842		2000-1999: OE Equivalent Fuel Cap .....	10825	
2010: Regular Locking Fuel Cap .....	10512		2000-1999: Regular Locking Fuel Cap .....	10595	
2010: Oil Filler Cap .....	10081		2000-1999: Oil Filler Cap .....	10138	
2009-2008: Lev-R-Vent Radiator Cap .....	✓10333	16			
2009-2008: OE Type Radiator Cap .....	10233	16			
2009-2008: OE Equivalent Fuel Cap .....	10842				
2009-2008: Regular Locking Fuel Cap .....	10512				
2009-2008: Oil Filler Cap .....	10081				

✓ Check Hood Clearance prior to installing this Cap.

## Caps for Passenger Cars and Light Trucks (1990 and Newer)

Application	Part Number	PSI	Application	Part Number	PSI
<b>Hyundai - Continued</b>			<b>Hyundai - Continued</b>		
<b>Entourage</b>			<b>Santa Fe - Continued</b>		
<b>V-6 3.8 L</b>			<b>V-6 2.7 L - Continued</b>		
2009-2008; Lev-R-Vent Radiator Cap .....	✓10333	16	2003; OE Type Radiator Cap .....	10233	16
2009-2008; OE Type Radiator Cap .....	10233	16	2003; OE Equivalent Fuel Cap .....	10825	
2009-2008; OE Equivalent Fuel Cap .....	10842		2003; Regular Locking Fuel Cap .....	10595	
2009-2008; Regular Locking Fuel Cap .....	10512		2003; Oil Filler Cap .....	10082	
2009-2008; Oil Filler Cap .....	10081		2002-2001; Lev-R-Vent Radiator Cap .....	✓10333	16
2007; Lev-R-Vent Radiator Cap .....	10333	16	2002-2001; OE Type Radiator Cap .....	10233	16
2007; OE Type Radiator Cap .....	10233	16	2002-2001; OE Equivalent Fuel Cap .....	10825	
2007; OE Equivalent Fuel Cap .....	10842		2002-2001; Regular Locking Fuel Cap .....	10595	
2007; Regular Locking Fuel Cap .....	10512		2002-2001; Oil Filler Cap .....	10143	
2007; Oil Filler Cap .....	10081				
<b>Equus</b>			<b>V-6 3.3 L</b>		
<b>V-8 4.6 L</b>			2009-2007; Lev-R-Vent Radiator Cap .....		
2011; OE Equivalent Fuel Cap .....	10842			✓10333	16
2011; Regular Locking Fuel Cap .....	10512		2009-2007; OE Type Radiator Cap .....	10233	16
2011; Oil Filler Cap .....	10081		2009-2007; OE Equivalent Fuel Cap .....	10842	
			2009-2007; Regular Locking Fuel Cap .....	10512	
			2009-2007; Oil Filler Cap .....	10081	
<b>Genesis</b>			<b>V-6 3.5 L</b>		
<b>4-Cyl. 2.0 L</b>			2011; OE Equivalent Fuel Cap .....		
2011; OE Equivalent Fuel Cap .....	10842			10842	
2011; Regular Locking Fuel Cap .....	10512		2011; Regular Locking Fuel Cap .....	10512	
2011; Oil Filler Cap .....	10081		2011; Oil Filler Cap .....	10081	
2010; Lev-R-Vent Radiator Cap .....	10333	16	2010; Lev-R-Vent Radiator Cap .....	10333	16
2010; OE Type Radiator Cap .....	10233	16	2010; OE Type Radiator Cap .....	10233	16
2010; OE Equivalent Fuel Cap .....	10842		2010; OE Equivalent Fuel Cap .....	10842	
2010; Regular Locking Fuel Cap .....	10512		2010; Regular Locking Fuel Cap .....	10512	
<b>V-6 3.8 L; V-8 4.6 L</b>			2006-2003; Lev-R-Vent Radiator Cap .....		
2011; OE Equivalent Fuel Cap .....	10842			✓10333	16
2011; Regular Locking Fuel Cap .....	10512		2006-2003; OE Type Radiator Cap .....	10233	16
2011; Oil Filler Cap .....	10081		2006-2003; OE Equivalent Fuel Cap .....	10825	
2010; Lev-R-Vent Radiator Cap .....	10333	16	2006-2003; Regular Locking Fuel Cap .....	10595	
2010; OE Type Radiator Cap .....	10233	16	2006-2003; Oil Filler Cap .....	10088	
2010; OE Equivalent Fuel Cap .....	10842				
2010; Regular Locking Fuel Cap .....	10512		<b>Scoupe</b>		
2010; Oil Filler Cap .....	10081		<b>4-Cyl. 1.5 L</b>		
2009; Lev-R-Vent Radiator Cap .....	✓10333	16	1995; Lev-R-Vent Radiator Cap .....	✓10327	13
2009; OE Type Radiator Cap .....	10233	16	1995; OE Type Radiator Cap .....	10227	13
2009; OE Equivalent Fuel Cap .....	10842		1995; OE Equivalent Fuel Cap .....	10825	
2009; Regular Locking Fuel Cap .....	10512		1995; Regular Locking Fuel Cap .....	10595	
2009; Oil Filler Cap .....	10081		1995; Oil Filler Cap; W/Turbo .....	10082	
			1995; Oil Filler Cap; W/O Turbo .....	10088	
<b>Santa Fe</b>			<b>Sonata</b>		
<b>4-Cyl. 2.4 L</b>			<b>4-Cyl. 2.0 L</b>		
2011; OE Equivalent Fuel Cap .....	10842		2011; OE Equivalent Fuel Cap .....	10842	
2011; Regular Locking Fuel Cap .....	10512		2011; Regular Locking Fuel Cap .....	10512	
2011; Oil Filler Cap .....	10081		2011; Oil Filler Cap .....	10082	
2010; Lev-R-Vent Radiator Cap .....	10333	16	1998-1995; Lev-R-Vent Radiator Cap .....	✓10327	13
2010; OE Type Radiator Cap .....	10233	16	1998-1995; OE Type Radiator Cap .....	10227	13
2010; OE Equivalent Fuel Cap .....	10842		1998-1995; OE Equivalent Fuel Cap .....	10825	
2010; Regular Locking Fuel Cap .....	10512		1998-1995; Regular Locking Fuel Cap .....	10595	
2004-2002; Lev-R-Vent Radiator Cap .....	✓10333	16	1998-1995; Oil Filler Cap .....	10088	
2004-2002; OE Type Radiator Cap .....	10233	16			
2004-2002; OE Equivalent Fuel Cap .....	10825		<b>4-Cyl. 2.4 L</b>		
2004-2002; Regular Locking Fuel Cap .....	10595		2011; Lev-R-Vent Radiator Cap .....		
2004-2002; Oil Filler Cap .....	10082			10333	16
2001; Lev-R-Vent Radiator Cap .....	✓10333	16	2011; OE Type Radiator Cap .....	10233	16
2001; OE Type Radiator Cap .....	10233	16	2011; OE Equivalent Fuel Cap .....	10842	
2001; OE Equivalent Fuel Cap .....	10825		2011; Regular Locking Fuel Cap .....	10512	
2001; Regular Locking Fuel Cap .....	10595		2011; Oil Filler Cap .....	10081	
2001; Oil Filler Cap .....	10088		2010; Lev-R-Vent Radiator Cap .....	10333	16
			2010; OE Type Radiator Cap .....	10233	16
<b>V-6 2.7 L</b>			2010; OE Equivalent Fuel Cap .....		
2009-2007; Lev-R-Vent Radiator Cap .....	✓10333	16		10842	
2009-2007; OE Type Radiator Cap .....	10233	16	2010; Regular Locking Fuel Cap .....	10512	
2009-2007; OE Equivalent Fuel Cap .....	10842		2009-2008; Lev-R-Vent Radiator Cap .....	✓10333	16
2009-2007; Regular Locking Fuel Cap .....	10512		2009-2008; OE Equivalent Fuel Cap .....	10233	16
2009-2007; Oil Filler Cap .....	10081		2009-2008; Regular Locking Fuel Cap .....	10512	
2006-2004; Lev-R-Vent Radiator Cap .....	✓10333	16	2009-2008; Oil Filler Cap .....	10081	
2006-2004; OE Type Radiator Cap .....	10233	16	2007; Lev-R-Vent Radiator Cap .....	10333	16
2006-2004; OE Equivalent Fuel Cap .....	10825		2007; OE Type Radiator Cap .....	10233	16
2006-2004; Regular Locking Fuel Cap .....	10595		2007; OE Equivalent Fuel Cap .....	10842	
2006-2004; Oil Filler Cap .....	10143		2007; Regular Locking Fuel Cap .....	10512	
2003; Lev-R-Vent Radiator Cap .....	✓10333	16	2007; Oil Filler Cap .....	10081	
			2006; Lev-R-Vent Radiator Cap .....	✓10333	16
			2006; OE Type Radiator Cap .....	10233	16
			2006; OE Equivalent Fuel Cap .....	10842	
			2006; Regular Locking Fuel Cap .....	10512	

✓ Check Hood Clearance prior to installing this Cap.

## Caps for Passenger Cars and Light Trucks (1990 and Newer)

Application	Part Number	PSI	Application	Part Number	PSI
<b>Hyundai - Continued</b>			<b>Hyundai - Continued</b>		
<b>Sonata - Continued</b>			<b>Tiburon - Continued</b>		
<b>4-Cyl. 2.4 L - Continued</b>			<b>4-Cyl. 2.0 L - Continued</b>		
2006; Oil Filler Cap .....	10081		2007; Oil Filler Cap .....	10081	
2005-2002; Lev-R-Vent Radiator Cap .....	✓10333	16	2006-2005; Lev-R-Vent Radiator Cap .....	✓10333	16
2005-2002; OE Type Radiator Cap .....	10233	16	2006-2005; OE Type Radiator Cap .....	10233	16
2005-2002; OE Equivalent Fuel Cap .....	10825		2006-2005; OE Equivalent Fuel Cap .....	10842	
2005-2002; Regular Locking Fuel Cap .....	10595		2006-2005; Regular Locking Fuel Cap .....	10512	
2005-2002; Oil Filler Cap .....	10082		2006-2005; Oil Filler Cap .....	10081	
2001-1999; Lev-R-Vent Radiator Cap .....	✓10333	16	2004-2003; Lev-R-Vent Radiator Cap .....	✓10333	16
2001-1999; OE Type Radiator Cap .....	10233	16	2004-2003; OE Type Radiator Cap .....	10233	16
2001-1999; OE Equivalent Fuel Cap .....	10825		2004-2003; OE Equivalent Fuel Cap .....	10825	
2001-1999; Regular Locking Fuel Cap .....	10595		2004-2003; Regular Locking Fuel Cap .....	10595	
2001-1999; Oil Filler Cap .....	10088		2004-2003; Oil Filler Cap .....	10081	
<b>V-6 2.5 L</b>			2001; Lev-R-Vent Radiator Cap; W/Auto. Trans. ....		
2001-1999; Lev-R-Vent Radiator Cap .....	✓10333	16	2001; OE Type Radiator Cap; W/Auto. Trans. ....	✓10333	16
2001-1999; OE Type Radiator Cap .....	10233	16	2001; Lev-R-Vent Radiator Cap; W/Man. Trans. ....	✓10327	13
2001-1999; OE Equivalent Fuel Cap .....	10825		2001; OE Type Radiator Cap; W/Man. Trans. ....	10227	13
2001-1999; Regular Locking Fuel Cap .....	10595		2001; OE Equivalent Fuel Cap .....	10825	
2001-1999; Oil Filler Cap .....	10143		2001; Regular Locking Fuel Cap .....	10595	
<b>V-6 2.7 L</b>			2001; Oil Filler Cap .....		
2005-2002; Lev-R-Vent Radiator Cap .....	✓10333	16	2000-1999; Lev-R-Vent Radiator Cap .....	✓10327	13
2005-2002; OE Type Radiator Cap .....	10233	16	2000-1999; OE Type Radiator Cap .....	10227	13
2005-2002; OE Equivalent Fuel Cap .....	10825		2000-1999; OE Equivalent Fuel Cap .....	10825	
2005-2002; Regular Locking Fuel Cap .....	10595		2000-1999; Regular Locking Fuel Cap .....	10595	
2005-2002; Oil Filler Cap .....	10143		2000-1999; Oil Filler Cap .....	10138	
<b>V-6 3.0 L</b>			1998; Lev-R-Vent Radiator Cap; W/Auto. Trans. ....		
1998-1995; Lev-R-Vent Radiator Cap .....	✓10327	13	1998; OE Type Radiator Cap; W/Auto. Trans. ....	✓10333	16
1998-1995; OE Type Radiator Cap .....	10227	13	1998; Lev-R-Vent Radiator Cap; W/Man. Trans. ....	✓10327	13
1998-1995; OE Equivalent Fuel Cap .....	10825		1998; OE Type Radiator Cap; W/Man. Trans. ....	10227	13
1998-1995; Regular Locking Fuel Cap .....	10595		1998; OE Equivalent Fuel Cap .....	10825	
1998-1995; Oil Filler Cap .....	10088		1998; Regular Locking Fuel Cap .....	10595	
<b>V-6 3.3 L</b>			1998; Oil Filler Cap .....		
2010; Lev-R-Vent Radiator Cap .....	10333	16	1997; Lev-R-Vent Radiator Cap .....	✓10327	13
2010; OE Type Radiator Cap .....	10233	16	1997; OE Type Radiator Cap .....	10227	13
2010; OE Equivalent Fuel Cap .....	10842		1997; OE Equivalent Fuel Cap .....	10825	
2010; Regular Locking Fuel Cap .....	10512		1997; Regular Locking Fuel Cap .....	10595	
2009-2008; Lev-R-Vent Radiator Cap .....	✓10333	16	1997; Oil Filler Cap .....	10138	
2009-2008; OE Type Radiator Cap .....	10233	16	<b>V-6 2.7 L</b>		
2009-2008; OE Equivalent Fuel Cap .....	10842		2008; Lev-R-Vent Radiator Cap .....	✓10333	16
2009-2008; Regular Locking Fuel Cap .....	10512		2008; OE Type Radiator Cap .....	10233	16
2009-2008; Oil Filler Cap .....	10081		2008; OE Equivalent Fuel Cap .....	10842	
2007; Lev-R-Vent Radiator Cap .....	10333	16	2008; Regular Locking Fuel Cap .....	10512	
2007; OE Type Radiator Cap .....	10233	16	2008; Oil Filler Cap .....	10143	
2007; OE Equivalent Fuel Cap .....	10842		2007; Lev-R-Vent Radiator Cap .....	10333	16
2007; Regular Locking Fuel Cap .....	10512		2007; OE Type Radiator Cap .....	10233	16
2007; Oil Filler Cap .....	10081		2007; OE Equivalent Fuel Cap .....	10842	
2006; Lev-R-Vent Radiator Cap .....	✓10333	16	2007; Regular Locking Fuel Cap .....	10512	
2006; OE Type Radiator Cap .....	10233	16	2007; Oil Filler Cap .....	10143	
2006; OE Equivalent Fuel Cap .....	10842		2006-2005; Lev-R-Vent Radiator Cap .....	✓10333	16
2006; Regular Locking Fuel Cap .....	10512		2006-2005; OE Type Radiator Cap .....	10233	16
2006; Oil Filler Cap .....	10081		2006-2005; OE Equivalent Fuel Cap .....	10842	
<b>Tiburon</b>			2006-2005; Regular Locking Fuel Cap .....		
<b>4-Cyl. 1.8 L</b>			2006-2005; Oil Filler Cap .....		
1998; Lev-R-Vent Radiator Cap .....	✓10333	16	2004-2003; Lev-R-Vent Radiator Cap .....	✓10333	16
1998; OE Type Radiator Cap .....	10233	16	2004-2003; OE Type Radiator Cap .....	10233	16
1998; OE Equivalent Fuel Cap .....	10825		2004-2003; OE Equivalent Fuel Cap .....	10825	
1998; Regular Locking Fuel Cap .....	10595		2004-2003; Regular Locking Fuel Cap .....	10595	
1997; Lev-R-Vent Radiator Cap .....	✓10327	13	2004-2003; Oil Filler Cap .....	10143	
1997; OE Type Radiator Cap .....	10227	13	<b>Tucson</b>		
1997; OE Equivalent Fuel Cap .....	10825		<b>4-Cyl. 2.0 L</b>		
1997; Regular Locking Fuel Cap .....	10595		2011; OE Equivalent Fuel Cap .....	10842	
1997; Oil Filler Cap .....	10138		2011; Regular Locking Fuel Cap .....	10512	
<b>4-Cyl. 2.0 L</b>			2011; Oil Filler Cap .....	10081	
2008; Lev-R-Vent Radiator Cap .....	✓10333	16	2009-2005; Lev-R-Vent Radiator Cap .....	✓10333	16
2008; OE Type Radiator Cap .....	10233	16	2009-2005; OE Type Radiator Cap .....	10233	16
2008; OE Equivalent Fuel Cap .....	10842		2009-2005; OE Equivalent Fuel Cap .....	10842	
2008; Regular Locking Fuel Cap .....	10512		2009-2005; Regular Locking Fuel Cap .....	10512	
2008; Oil Filler Cap .....	10081		2009-2005; Oil Filler Cap .....	10081	
2007; Lev-R-Vent Radiator Cap .....	10333	16	<b>4-Cyl. 2.4 L</b>		
2007; OE Type Radiator Cap .....	10233	16	2011; OE Equivalent Fuel Cap .....	10842	
2007; OE Equivalent Fuel Cap .....	10842		2011; Regular Locking Fuel Cap .....	10512	
2007; Regular Locking Fuel Cap .....	10512		2011; Oil Filler Cap .....	10081	
			2010; Lev-R-Vent Radiator Cap .....	10333	16

✓ Check Hood Clearance prior to installing this Cap.

## Caps for Passenger Cars and Light Trucks (1990 and Newer)

Application	Part Number	PSI	Application	Part Number	PSI
<b>Hyundai - Continued</b>			<b>Infiniti - Continued</b>		
<b>Tucson - Continued</b>			<b>FX35 - Continued</b>		
<b>4-Cyl. 2.4 L - Continued</b>			<b>V-6 3.5 L - Continued</b>		
2010; OE Type Radiator Cap .....	10233	16	2008-2007; OE Equivalent Fuel Cap .....	10838	
2010; OE Equivalent Fuel Cap .....	10842		2008-2007; Regular Locking Fuel Cap .....	10508	
2010; Regular Locking Fuel Cap .....	10512		2008-2007; Oil Filler Cap .....	10107	
<b>V-6 2.7 L</b>			2006; Lev-R-Vent Radiator Cap .....	10327	13
2009-2006; Lev-R-Vent Radiator Cap .....	✓10333	16	2006; OE Type Radiator Cap .....	10227	13
2009-2006; OE Type Radiator Cap .....	10233	16	2006; OE Equivalent Fuel Cap .....	10838	
2009-2006; OE Equivalent Fuel Cap .....	10842		2006; Regular Locking Fuel Cap .....	10508	
2009-2006; Regular Locking Fuel Cap .....	10512		2005-2003; Lev-R-Vent Radiator Cap .....	✓10327	13
2009-2006; Oil Filler Cap .....	10143		2005-2003; OE Type Radiator Cap .....	10227	13
2005; Lev-R-Vent Radiator Cap .....	✓10333	16	2005-2003; OE Equivalent Fuel Cap .....	10838	
2005; OE Type Radiator Cap .....	10233	16	2005-2003; Regular Locking Fuel Cap .....	10508	
2005; OE Equivalent Fuel Cap .....	10842		2005-2003; Oil Filler Cap .....	10107	
2005; Regular Locking Fuel Cap .....	10512		<b>FX45</b>		
2005; Oil Filler Cap; GLS .....	10081		<b>V-8 4.5 L</b>		
2005; Oil Filler Cap; LX .....	10143		2008-2007; Lev-R-Vent Radiator Cap .....	10327	13
<b>Veracruz</b>			2008-2007; OE Type Radiator Cap .....	10227	13
<b>V-6 3.8 L</b>			2008-2007; OE Equivalent Fuel Cap .....	10838	
2011; OE Equivalent Fuel Cap .....	10842		2008-2007; Regular Locking Fuel Cap .....	10508	
2011; Regular Locking Fuel Cap .....	10512		2008-2007; Oil Filler Cap .....	10107	
2011; Oil Filler Cap .....	10081		2006; Lev-R-Vent Radiator Cap .....	10327	13
2010; Lev-R-Vent Radiator Cap .....	10333	16	2006; OE Type Radiator Cap .....	10227	13
2010; OE Type Radiator Cap .....	10233	16	2006; OE Equivalent Fuel Cap .....	10838	
2010; OE Equivalent Fuel Cap .....	10842		2006; Regular Locking Fuel Cap .....	10508	
2010; Regular Locking Fuel Cap .....	10512		2005-2003; Lev-R-Vent Radiator Cap .....	✓10327	13
2009-2008; Lev-R-Vent Radiator Cap .....	✓10333	16	2005-2003; OE Type Radiator Cap .....	10227	13
2009-2008; OE Type Radiator Cap .....	10233	16	2005-2003; OE Equivalent Fuel Cap .....	10838	
2009-2008; OE Equivalent Fuel Cap .....	10842		2005-2003; Regular Locking Fuel Cap .....	10508	
2009-2008; Regular Locking Fuel Cap .....	10512		2005-2003; Oil Filler Cap .....	10107	
2009-2008; Oil Filler Cap .....	10081		<b>FX50</b>		
2007; Lev-R-Vent Radiator Cap .....	10333	16	<b>V-8 5.0 L</b>		
2007; OE Type Radiator Cap .....	10233	16	2011; OE Equivalent Fuel Cap .....	10842	
2007; Oil Filler Cap .....	10082		2011; Regular Locking Fuel Cap .....	10512	
<b>XG300</b>			2010; OE Type Radiator Cap .....	10267	20
<b>V-6 3.0 L</b>			2010; Oil Filler Cap .....	10107	
2001; Lev-R-Vent Radiator Cap .....	✓10333	16	2009; OE Type Radiator Cap .....	10267	20
2001; OE Type Radiator Cap .....	10233	16	2009; OE Equivalent Fuel Cap .....	10838	
2001; OE Equivalent Fuel Cap .....	10825		2009; Regular Locking Fuel Cap .....	10508	
2001; Regular Locking Fuel Cap .....	10595		2009; Oil Filler Cap .....	10107	
2001; Oil Filler Cap .....	10088		<b>G20</b>		
<b>XG350</b>			<b>4-Cyl. 2.0 L</b>		
<b>V-6 3.5 L</b>			2002-2001; Lev-R-Vent Radiator Cap .....	✓10327	13
2005-2002; Lev-R-Vent Radiator Cap .....	✓10333	16	2002-2001; OE Type Radiator Cap .....	10227	13
2005-2002; OE Type Radiator Cap .....	10233	16	2002-2001; OE Equivalent Fuel Cap .....	10834	
2005-2002; OE Equivalent Fuel Cap .....	10825		2002-2001; Regular Locking Fuel Cap .....	10504	
2005-2002; Regular Locking Fuel Cap .....	10595		2002-2001; Oil Filler Cap .....	10107	
2005-2002; Oil Filler Cap .....	10088		2000-1999; Lev-R-Vent Radiator Cap .....	✓10327	13
<b>Infiniti</b>			2000-1999; OE Type Radiator Cap .....	10227	13
<b>EX35</b>			2000-1999; OE Equivalent Fuel Cap .....	10817	
<b>V-6 3.5 L</b>			2000-1999; Pre-Vent Non-Locking Fuel Cap .....	10819	
2011; OE Equivalent Fuel Cap .....	10842		2000-1999; Regular Locking Fuel Cap .....	10591	
2011; Regular Locking Fuel Cap .....	10512		2000-1999; Pre-Vent Locking Fuel Cap .....	10501	
2010-2008; OE Type Radiator Cap .....	10267	20	2000-1999; Oil Filler Cap .....	10107	
2010-2008; OE Equivalent Fuel Cap .....	10838		1996-1995; Lev-R-Vent Radiator Cap .....	✓10327	13
2010-2008; Regular Locking Fuel Cap .....	10508		1996-1995; OE Type Radiator Cap .....	10227	13
2010-2008; Oil Filler Cap .....	10107		1996-1995; OE Equivalent Fuel Cap .....	10817	
<b>FX35</b>			1996-1995; Pre-Vent Non-Locking Fuel Cap .....	10819	
<b>V-6 3.5 L</b>			1996-1995; Regular Locking Fuel Cap .....	10591	
2011; OE Equivalent Fuel Cap .....	10842		1996-1995; Pre-Vent Locking Fuel Cap .....	10501	
2011; Regular Locking Fuel Cap .....	10512		1996-1995; Oil Filler Cap .....	10107	
2010; OE Type Radiator Cap .....	10267	20	<b>G35</b>		
2010; Oil Filler Cap .....	10107		<b>V-6 3.5 L</b>		
2009; OE Type Radiator Cap .....	10267	20	2008; OE Type Radiator Cap .....	10267	20
2009; OE Equivalent Fuel Cap .....	10838		2008; OE Equivalent Fuel Cap .....	10838	
2009; Regular Locking Fuel Cap .....	10508		2008; Regular Locking Fuel Cap .....	10508	
2009; Oil Filler Cap .....	10107		2008; Oil Filler Cap .....	10107	
2008-2007; Lev-R-Vent Radiator Cap .....	10327	13	2007; Lev-R-Vent Radiator Cap; Early .....	10327	13
2008-2007; OE Type Radiator Cap .....	10227	13	2007; OE Type Radiator Cap; Early .....	10227	13
<b>Hyundai - Continued</b>			2007; OE Type Radiator Cap; Late .....	10267	20
<b>Tucson - Continued</b>			2007; OE Equivalent Fuel Cap .....	10838	
<b>4-Cyl. 2.4 L - Continued</b>			<b>Infiniti - Continued</b>		
<b>V-6 2.7 L</b>			<b>FX35 - Continued</b>		
<b>V-6 3.8 L</b>			<b>V-6 3.5 L - Continued</b>		
<b>XG300</b>			<b>V-8 4.5 L</b>		
<b>V-6 3.0 L</b>			<b>FX50</b>		
<b>XG350</b>			<b>V-8 5.0 L</b>		
<b>Infiniti</b>			<b>G20</b>		
<b>EX35</b>			<b>4-Cyl. 2.0 L</b>		
<b>V-6 3.5 L</b>			<b>G35</b>		
<b>FX35</b>			<b>V-6 3.5 L</b>		
<b>V-6 3.5 L</b>			<b>V-6 3.5 L</b>		

✓ Check Hood Clearance prior to installing this Cap.



## Caps for Passenger Cars and Light Trucks (1990 and Newer)

Application	Part Number	PSI	Application	Part Number	PSI
<b>Infiniti - Continued</b>			<b>Infiniti - Continued</b>		
<b>G35 - Continued</b>			<b>M37</b>		
<b>V-6 3.5 L - Continued</b>			<b>V-6 3.7 L</b>		
2007; Regular Locking Fuel Cap .....	10508		2012; OE Equivalent Fuel Cap .....	10838	
2007; Oil Filler Cap .....	10107		2012; Regular Locking Fuel Cap .....	10508	
2006-2003; Lev-R-Vent Radiator Cap .....	✓10327	13	2011; OE Equivalent Fuel Cap .....	10842	
2006-2003; OE Type Radiator Cap .....	10227	13	2011; Regular Locking Fuel Cap .....	10512	
2006-2003; OE Equivalent Fuel Cap .....	10838		2011; Oil Filler Cap .....	10107	
2006-2003; Regular Locking Fuel Cap .....	10508				
2006-2003; Oil Filler Cap .....	10107				
<b>G37</b>			<b>M45</b>		
<b>V-6 3.7 L</b>			<b>V-8 4.5 L</b>		
2011; OE Equivalent Fuel Cap .....	10838		2010; Lev-R-Vent Radiator Cap .....	10327	13
2011; Regular Locking Fuel Cap .....	10508		2010; OE Type Radiator Cap .....	10227	13
2010-2008; OE Type Radiator Cap .....	10267	20	2010; OE Equivalent Fuel Cap .....	10842	
2010-2008; OE Equivalent Fuel Cap .....	10838		2010; Regular Locking Fuel Cap .....	10512	
2010-2008; Regular Locking Fuel Cap .....	10508		2010; Oil Filler Cap .....	10107	
2010-2008; Oil Filler Cap .....	10107		2009; Lev-R-Vent Radiator Cap .....	10333	16
			2009; OE Type Radiator Cap .....	10233	16
			2009; OE Equivalent Fuel Cap .....	10838	
			2009; Regular Locking Fuel Cap .....	10508	
			2009; Oil Filler Cap .....	10107	
			2008-2007; Lev-R-Vent Radiator Cap .....	10327	13
			2008-2007; OE Type Radiator Cap .....	10227	13
			2008-2007; OE Equivalent Fuel Cap .....	10838	
			2008-2007; Regular Locking Fuel Cap .....	10508	
			2008-2007; Oil Filler Cap .....	10107	
			2006; Lev-R-Vent Radiator Cap .....	✓10327	13
			2006; OE Type Radiator Cap .....	10227	13
			2006; OE Equivalent Fuel Cap .....	10838	
			2006; Regular Locking Fuel Cap .....	10508	
			2006; Oil Filler Cap .....	10107	
			2004-2003; Lev-R-Vent Radiator Cap .....	✓10327	13
			2004-2003; OE Type Radiator Cap .....	10227	13
			2004-2003; OE Equivalent Fuel Cap .....	10838	
			2004-2003; Regular Locking Fuel Cap .....	10508	
			2004-2003; Oil Filler Cap .....	10107	
<b>I30</b>			<b>M56</b>		
<b>V-6 3.0 L</b>			<b>V-8 5.6 L</b>		
2001; Lev-R-Vent Radiator Cap .....	✓10327	13	2012; OE Equivalent Fuel Cap .....	10838	
2001; OE Type Radiator Cap .....	10227	13	2012; Regular Locking Fuel Cap .....	10508	
2001; OE Equivalent Fuel Cap .....	10834		2011; OE Equivalent Fuel Cap .....	10842	
2001; Regular Locking Fuel Cap .....	10504		2011; Regular Locking Fuel Cap .....	10512	
2001; Oil Filler Cap .....	10107		2011; Oil Filler Cap .....	10107	
2000-1996; Lev-R-Vent Radiator Cap .....	✓10327	13			
2000-1996; OE Type Radiator Cap .....	10227	13			
2000-1996; OE Equivalent Fuel Cap .....	10817				
2000-1996; Pre-Vent Non-Locking Fuel Cap .....	10819				
2000-1996; Regular Locking Fuel Cap .....	10591				
2000-1996; Pre-Vent Locking Fuel Cap .....	10501				
2000-1996; Oil Filler Cap .....	10107				
<b>I35</b>			<b>Q45</b>		
<b>V-6 3.5 L</b>			<b>V-8 4.1 L</b>		
2004-2002; Lev-R-Vent Radiator Cap .....	✓10327	13	2001; Lev-R-Vent Radiator Cap .....	✓10333	16
2004-2002; OE Type Radiator Cap .....	10227	13	2001; OE Type Radiator Cap .....	10233	16
2004-2002; OE Equivalent Fuel Cap .....	10838		2001; OE Equivalent Fuel Cap .....	10834	
2004-2002; Regular Locking Fuel Cap .....	10508		2001; Regular Locking Fuel Cap .....	10504	
2004-2002; Oil Filler Cap .....	10107		2001; Oil Filler Cap .....	10107	
			2000-1997; Lev-R-Vent Radiator Cap .....	✓10333	16
			2000-1997; OE Type Radiator Cap .....	10233	16
			2000-1997; OE Equivalent Fuel Cap .....	10817	
			2000-1997; Pre-Vent Non-Locking Fuel Cap .....	10819	
			2000-1997; Regular Locking Fuel Cap .....	10591	
			2000-1997; Pre-Vent Locking Fuel Cap .....	10501	
			2000-1997; Oil Filler Cap .....	10107	
<b>J30</b>			<b>V-8 4.5 L</b>		
<b>V-6 3.0 L</b>			2006; Lev-R-Vent Radiator Cap .....		
1997-1995; Lev-R-Vent Radiator Cap .....	✓10327	13		✓10327	13
1997-1995; OE Type Radiator Cap .....	10227	13	2006; OE Type Radiator Cap .....	10227	13
1997-1995; OE Equivalent Fuel Cap .....	10817		2006; OE Equivalent Fuel Cap .....	10838	
1997-1995; Pre-Vent Non-Locking Fuel Cap .....	10819		2006; Regular Locking Fuel Cap .....	10508	
1997-1995; Regular Locking Fuel Cap .....	10591		2006; Oil Filler Cap .....	10107	
1997-1995; Pre-Vent Locking Fuel Cap .....	10501				
1997-1995; Oil Filler Cap .....	10107				
<b>M35</b>			<b>V-8 4.5 L</b>		
<b>V-6 3.5 L</b>			2006; Lev-R-Vent Radiator Cap .....		
2010-2009; Lev-R-Vent Radiator Cap .....	10333	16		✓10327	13
2010-2009; OE Type Radiator Cap .....	10233	16	2006; OE Type Radiator Cap .....	10227	13
2010-2009; OE Equivalent Fuel Cap .....	10838		2006; OE Equivalent Fuel Cap .....	10838	
2010-2009; Regular Locking Fuel Cap .....	10508		2006; Regular Locking Fuel Cap .....	10508	
2010-2009; Oil Filler Cap .....	10107		2005-2002; Lev-R-Vent Radiator Cap .....	✓10327	13
2008-2007; Lev-R-Vent Radiator Cap .....	10327	13	2005-2002; OE Type Radiator Cap .....	10227	13
2008-2007; OE Type Radiator Cap .....	10227	13	2005-2002; OE Equivalent Fuel Cap .....	10838	
2008-2007; OE Equivalent Fuel Cap .....	10838		2005-2002; Regular Locking Fuel Cap .....	10508	
2008-2007; Regular Locking Fuel Cap .....	10508		2005-2002; Oil Filler Cap .....	10107	
2008-2007; Oil Filler Cap .....	10107		1996-1995; Lev-R-Vent Radiator Cap .....	✓10327	13
2006; Lev-R-Vent Radiator Cap .....	✓10327	13	1996-1995; OE Type Radiator Cap .....	10227	13
2006; OE Type Radiator Cap .....	10227	13	1996-1995; OE Equivalent Fuel Cap .....	10817	
2006; OE Equivalent Fuel Cap .....	10838		1996-1995; Pre-Vent Non-Locking Fuel Cap .....	10819	
2006; Regular Locking Fuel Cap .....	10508		1996-1995; Regular Locking Fuel Cap .....	10591	
2006; Oil Filler Cap .....	10107		1996-1995; Pre-Vent Locking Fuel Cap .....	10501	
			1996-1995; Oil Filler Cap .....	10107	
<b>M35h</b>			<b>V-6 3.5 L Electric Assist</b>		
<b>V-6 3.5 L Electric Assist</b>			2012; OE Equivalent Fuel Cap .....		
				10838	
				2012; Regular Locking Fuel Cap .....	
				10508	

✓ Check Hood Clearance prior to installing this Cap.

## Caps for Passenger Cars and Light Trucks (1990 and Newer)

Application	Part Number	PSI	Application	Part Number	PSI
<b>Infiniti - Continued</b>			<b>Isuzu - Continued</b>		
<b>QX4</b>			<b>Axiom</b>		
<b>V-6 3.3 L</b>			<b>V-6 3.5 L</b>		
2000-1997: Lev-R-Vent Radiator Cap .....	✓10327	13	2004-2002: Lev-R-Vent Radiator Cap .....	✓10333	16
2000-1997: OE Type Radiator Cap .....	10227	13	2004-2002: OE Type Radiator Cap .....	10233	16
2000-1997: OE Equivalent Fuel Cap .....	10817		2004-2002: OE Equivalent Fuel Cap .....	10834	
2000-1997: Pre-Vent Non-Locking Fuel Cap .....	10819		2004-2002: Regular Locking Fuel Cap .....	10504	
2000-1997: Regular Locking Fuel Cap .....	10591		2004-2002: Oil Filler Cap .....	10101	
2000-1997: Pre-Vent Locking Fuel Cap .....	10501				
2000-1997: Oil Filler Cap .....	10107		<b>Hombre</b>		
<b>V-6 3.5 L</b>			<b>4-Cyl. 2.2 L</b>		
2003-2002: Lev-R-Vent Radiator Cap .....	✓10327	13	2000-1998: Lev-R-Vent Radiator Cap .....	10330	16
2003-2002: OE Type Radiator Cap .....	10227	13	2000-1998: OE Type Radiator Cap .....	10230	16
2003-2002: OE Equivalent Fuel Cap .....	10838		2000-1998: OE Equivalent Fuel Cap .....	10836	
2003-2002: Regular Locking Fuel Cap .....	10508		2000-1998: Regular Locking Fuel Cap .....	10506	
2003-2002: Oil Filler Cap .....	10107		2000-1998: Oil Filler Cap .....	10125	
2001: Lev-R-Vent Radiator Cap .....	✓10327	13	1997: Lev-R-Vent Radiator Cap .....	10330	16
2001: OE Type Radiator Cap .....	10227	13	1997: OE Type Radiator Cap .....	10230	16
2001: OE Equivalent Fuel Cap .....	10834		1997: OE Equivalent Fuel Cap .....	10836	
2001: Regular Locking Fuel Cap .....	10504		1997: Regular Locking Fuel Cap .....	10506	
2001: Oil Filler Cap .....	10107		1997: Oil Filler Cap .....	10128	
<b>QX56</b>			1996: Lev-R-Vent Radiator Cap .....		
<b>V-8 5.6 L</b>			1996: OE Type Radiator Cap .....		
2011: OE Equivalent Fuel Cap .....	10838		1996: OE Equivalent Fuel Cap .....	10834	
2011: Regular Locking Fuel Cap .....	10508		1996: Regular Locking Fuel Cap .....	10504	
2010: Oil Filler Cap .....	10107		1996: Oil Filler Cap .....	10128	
2009-2004: OE Type Radiator Cap .....	10264	42	<b>V-6 4.3 L</b>		
2009-2004: Coolant Recovery Tank Cap .....	10238		2000-1997: Lev-R-Vent Radiator Cap .....	10330	16
2009-2004: OE Equivalent Fuel Cap .....	10838		2000-1997: OE Type Radiator Cap .....	10230	16
2009-2004: Regular Locking Fuel Cap .....	10508		2000-1997: OE Equivalent Fuel Cap .....	10836	
2009-2004: Oil Filler Cap .....	10107		2000-1997: Regular Locking Fuel Cap .....	10506	
<b>ISUZU</b>			2000-1997: Oil Filler Cap .....		
<b>Amigo</b>			10099		
<b>4-Cyl. 2.2 L</b>			<b>I-280</b>		
2000-1999: OE Type Radiator Cap .....	10242	16	<b>4-Cyl. 2.8 L</b>		
2000-1999: OE Equivalent Fuel Cap .....	10834		2006: OE Type Radiator Cap .....		
2000-1999: Regular Locking Fuel Cap .....	10504		2006: OE Equivalent Fuel Cap .....		
2000-1999: Oil Filler Cap .....	10101		2006: Regular Locking Fuel Cap .....		
<b>V-6 3.2 L</b>			2006: Oil Filler Cap .....		
2000: Lev-R-Vent Radiator Cap .....	✓10333	16	10099		
2000: OE Type Radiator Cap .....	10233	16	<b>I-290</b>		
2000: OE Equivalent Fuel Cap .....	10834		<b>4-Cyl. 2.9 L</b>		
2000: Regular Locking Fuel Cap .....	10504		2008-2007: OE Type Radiator Cap .....		
2000: Oil Filler Cap .....	10081		2008-2007: OE Equivalent Fuel Cap .....		
1999-1998: Lev-R-Vent Radiator Cap .....	✓10333	16	2008-2007: Regular Locking Fuel Cap .....		
1999-1998: OE Type Radiator Cap .....	10233	16	2008-2007: Oil Filler Cap .....		
1999-1998: OE Equivalent Fuel Cap .....	10834		<b>I-350</b>		
1999-1998: Regular Locking Fuel Cap .....	10504		<b>5-Cyl. 3.5 L</b>		
1999-1998: Oil Filler Cap .....	10101		2006: OE Type Radiator Cap .....		
<b>Ascender</b>			2006: OE Equivalent Fuel Cap .....		
<b>6-Cyl. 4.2 L</b>			2006: Regular Locking Fuel Cap .....		
2008-2005: OE Type Radiator Cap .....	10248	15	2006: Oil Filler Cap .....		
2008-2005: OE Equivalent Fuel Cap .....	10841		10099		
2008-2005: Regular Locking Fuel Cap .....	10511		<b>I-370</b>		
2008-2005: Oil Filler Cap .....	10099		<b>5-Cyl. 3.7 L</b>		
2004-2003: OE Type Radiator Cap .....	10248	15	2008-2007: OE Type Radiator Cap .....		
2004-2003: OE Equivalent Fuel Cap .....	10836		2008-2007: OE Equivalent Fuel Cap .....		
2004-2003: Regular Locking Fuel Cap .....	10506		2008-2007: Regular Locking Fuel Cap .....		
2004-2003: Oil Filler Cap .....	10099		2008-2007: Oil Filler Cap .....		
<b>V-8 5.3 L</b>			<b>Oasis</b>		
2006-2005: OE Type Radiator Cap .....	10248	15	<b>4-Cyl. 2.2 L</b>		
2006-2005: OE Equivalent Fuel Cap .....	10841		1997-1996: OE Type Radiator Cap .....		
2006-2005: Regular Locking Fuel Cap .....	10511		1997-1996: OE Equivalent Fuel Cap .....		
2006-2005: Oil Filler Cap .....	10099		1997-1996: Regular Locking Fuel Cap .....		
2004-2003: OE Type Radiator Cap .....	10248	15	1997-1996: Oil Filler Cap .....		
2004-2003: OE Equivalent Fuel Cap .....	10836		<b>4-Cyl. 2.3 L</b>		
2004-2003: Regular Locking Fuel Cap .....	10506		1999-1998: OE Type Radiator Cap .....		
2004-2003: Oil Filler Cap .....	10099		1999-1998: OE Equivalent Fuel Cap .....		
<b>Pickup</b>			1999-1998: Regular Locking Fuel Cap .....		
<b>4-Cyl. 2.3 L; 4-Cyl. 2.6 L</b>			1999-1998: Oil Filler Cap .....		
1995: Lev-R-Vent Radiator Cap .....			✓10333		
			16		

✓ Check Hood Clearance prior to installing this Cap.

## Caps for Passenger Cars and Light Trucks (1990 and Newer)

Application	Part Number	PSI	Application	Part Number	PSI
<b>Isuzu - Continued</b>			<b>Isuzu - Continued</b>		
<b>Pickup - Continued</b>			<b>Vehicross</b>		
<b>4-Cyl. 2.3 L; 4-Cyl. 2.6 L - Continued</b>			<b>V-6 3.5 L</b>		
1995; OE Type Radiator Cap .....	10233	16	2001-1999; Lev-R-Vent Radiator Cap .....	✓10333	16
1995; OE Equivalent Fuel Cap .....	10834		2001-1999; OE Type Radiator Cap .....	10233	16
1995; Regular Locking Fuel Cap .....	10504		2001-1999; OE Equivalent Fuel Cap .....	10834	
1995; Oil Filler Cap .....	10101		2001-1999; Regular Locking Fuel Cap .....	10504	
<b>Rodeo</b>			2001-1999; Oil Filler Cap .....		
<b>4-Cyl. 2.2 L</b>			<b>2001-1999; Oil Filler Cap .....</b>		
2003-2001; OE Type Radiator Cap .....	10242	16	<b>Jaguar</b>		
2003-2001; OE Equivalent Fuel Cap .....	10834		<b>S-Type</b>		
2003-2001; Regular Locking Fuel Cap .....	10504		<b>V-6 3.0 L</b>		
2000; OE Type Radiator Cap .....	10242	16	2008-2005; OE Type Radiator Cap .....	10238	16
2000; OE Equivalent Fuel Cap .....	10834		2008-2005; OE Equivalent Fuel Cap .....	10851	
2000; Regular Locking Fuel Cap .....	10504		2008-2005; Regular Locking Fuel Cap .....	10521	
2000; Oil Filler Cap .....	10101		2008-2005; Oil Filler Cap .....	10117	
1999-1998; OE Type Radiator Cap .....	10242	16	2004-2000; OE Type Radiator Cap .....	10238	16
1999-1998; OE Equivalent Fuel Cap .....	10834		2004-2000; Oil Filler Cap .....	10117	
1999-1998; Regular Locking Fuel Cap .....	10504		<b>V-8 4.0 L</b>		
<b>4-Cyl. 2.6 L</b>			2002-2000; OE Type Radiator Cap .....		
1997-1995; Lev-R-Vent Radiator Cap .....	✓10333	16	<b>V-8 4.2 L</b>		
1997-1995; OE Type Radiator Cap .....	10233	16	2008-2005; OE Type Radiator Cap .....	10238	16
1997-1995; OE Equivalent Fuel Cap .....	10834		2008-2005; OE Equivalent Fuel Cap .....	10851	
1997-1995; Regular Locking Fuel Cap .....	10504		2008-2005; Regular Locking Fuel Cap .....	10521	
1997-1995; Oil Filler Cap .....	10101		2004-2003; OE Type Radiator Cap .....	10238	16
<b>V-6 3.2 L</b>			<b>Super V8</b>		
2004-1996; Lev-R-Vent Radiator Cap .....	✓10333	16	<b>V-8 4.2 L</b>		
2004-1996; OE Type Radiator Cap .....	10233	16	2009; OE Type Radiator Cap .....	10238	16
2004-1996; OE Equivalent Fuel Cap .....	10834		2008-2005; OE Type Radiator Cap .....	10238	16
2004-1996; Regular Locking Fuel Cap .....	10504		2008-2005; Oil Filler Cap .....	10101	
2004-1996; Oil Filler Cap .....	10101		<b>Vanden Plas</b>		
1995; Lev-R-Vent Radiator Cap .....	✓10333	16	<b>V-8 4.0 L</b>		
1995; OE Type Radiator Cap .....	10233	16	2003-1998; OE Type Radiator Cap .....		
1995; OE Equivalent Fuel Cap .....	10834		<b>V-8 4.2 L</b>		
1995; Regular Locking Fuel Cap .....	10504		2009-2004; OE Type Radiator Cap .....		
1995; Oil Filler Cap .....	10134		<b>X-Type</b>		
<b>V-6 3.5 L</b>			<b>V-6 2.5 L</b>		
2004; Lev-R-Vent Radiator Cap .....	✓10333	16	2005-2002; OE Type Radiator Cap .....	10263	15
2004; OE Type Radiator Cap .....	10233	16	2005-2002; OE Equivalent Fuel Cap; W/Threaded Filler Neck ...	10837	
2004; OE Equivalent Fuel Cap .....	10834		2005-2002; Regular Locking Fuel Cap; W/Threaded Filler Neck .	10507	
2004; Regular Locking Fuel Cap .....	10504		2005-2002; OE Equivalent Fuel Cap; W/O Threaded Filler Neck .	10851	
2004; Oil Filler Cap .....	10101		2005-2002; Regular Locking Fuel Cap; W/O Threaded Filler Neck	10521	
<b>Trooper</b>			2005-2002; Oil Filler Cap .....	10117	
<b>V-6 3.2 L</b>			<b>V-6 3.0 L</b>		
1997-1996; Lev-R-Vent Radiator Cap .....	✓10333	16	2008; OE Type Radiator Cap .....	10238	16
1997-1996; OE Type Radiator Cap .....	10233	16	2008; OE Equivalent Fuel Cap .....	10837	
1997-1996; OE Equivalent Fuel Cap .....	10834		2008; Regular Locking Fuel Cap .....	10507	
1997-1996; Regular Locking Fuel Cap .....	10504		2008; Oil Filler Cap .....	10117	
1997-1996; Oil Filler Cap .....	10101		2007-2002; OE Type Radiator Cap .....	10263	15
1995; Lev-R-Vent Radiator Cap .....	✓10333	16	2007-2002; OE Equivalent Fuel Cap; W/Threaded Filler Neck ...	10837	
1995; OE Type Radiator Cap .....	10233	16	2007-2002; Regular Locking Fuel Cap; W/Threaded Filler Neck .	10507	
1995; OE Equivalent Fuel Cap .....	10834		2007-2002; OE Equivalent Fuel Cap; W/O Threaded Filler Neck .	10851	
1995; Regular Locking Fuel Cap .....	10504		2007-2002; Regular Locking Fuel Cap; W/O Threaded Filler Neck	10521	
1995; Oil Filler Cap .....	10134		2007-2002; Oil Filler Cap .....	10117	
<b>V-6 3.5 L</b>			<b>XF</b>		
2002-2001; Lev-R-Vent Radiator Cap .....	✓10333	16	<b>V-8 4.2 L</b>		
2002-2001; OE Type Radiator Cap .....	10233	16	2010; OE Type Radiator Cap .....		
2002-2001; OE Equivalent Fuel Cap .....	10834		2010; Oil Filler Cap .....		
2002-2001; Regular Locking Fuel Cap .....	10504		2009; OE Type Radiator Cap .....		
2002-2001; Oil Filler Cap .....	10101		<b>V-8 5.0 L</b>		
2000-1999; Lev-R-Vent Radiator Cap .....	✓10333	16	2010; OE Type Radiator Cap .....		
2000-1999; OE Type Radiator Cap .....	10233	16	<b>XFR</b>		
2000-1999; OE Equivalent Fuel Cap .....	10834		<b>V-8 5.0 L</b>		
2000-1999; Regular Locking Fuel Cap .....	10504		2010; OE Type Radiator Cap .....		
2000-1999; Oil Filler Cap .....	10081		2010; OE Type Radiator Cap .....		
1998; Lev-R-Vent Radiator Cap .....	✓10333	16	2010; OE Type Radiator Cap .....		
1998; OE Type Radiator Cap .....	10233	16	2010; OE Type Radiator Cap .....		
1998; OE Equivalent Fuel Cap .....	10834		2010; OE Type Radiator Cap .....		
1998; Regular Locking Fuel Cap .....	10504		2010; OE Type Radiator Cap .....		
1998; Oil Filler Cap .....	10101		2010; OE Type Radiator Cap .....		

✓ Check Hood Clearance prior to installing this Cap.

## Caps for Passenger Cars and Light Trucks (1990 and Newer)

Application	Part Number	PSI	Application	Part Number	PSI
<b>Jaguar - Continued</b>			<b>Jeep - Continued</b>		
<b>XJ8</b>			<b>Cherokee - Continued</b>		
V-8 4.0 L			6-Cyl. 4.0 L - Continued		
2003-1998; OE Type Radiator Cap .....	10263	15	2001-2000; OE Type Radiator Cap .....	10231	16
V-8 4.2 L			2001-2000; OE Equivalent Fuel Cap .....	10838	
2009-2006; OE Type Radiator Cap .....	10238	16	2001-2000; Regular Locking Fuel Cap .....	10508	
2005; OE Type Radiator Cap .....	10263	15	2001-2000; Oil Filler Cap .....	10111	
2004; OE Type Radiator Cap .....	10238	16	1999-1996; Lev-R-Vent Radiator Cap .....	10331	16
<b>XJR</b>			1999-1996; OE Type Radiator Cap .....	10231	16
V-8 4.0 L			1999-1996; OE Equivalent Fuel Cap .....	10817	
2003-2002; OE Type Radiator Cap .....	10238	16	1999-1996; Pre-Vent Non-Locking Fuel Cap .....	10819	
2001-1998; OE Type Radiator Cap .....	10263	15	1999-1996; Regular Locking Fuel Cap .....	10591	
V-8 4.2 L			1999-1996; Pre-Vent Locking Fuel Cap .....	10501	
2009-2004; OE Type Radiator Cap .....	10238	16	1999-1996; Oil Filler Cap .....	10111	
<b>XJS</b>			1995; Lev-R-Vent Radiator Cap .....	10329	13
6-Cyl. 4.0 L			1995; OE Type Radiator Cap .....	10229	13
1996-1995; Lev-R-Vent Radiator Cap .....	10330	16	1995; OE Equivalent Fuel Cap .....	10817	
1996-1995; OE Type Radiator Cap .....	10230	16	1995; Pre-Vent Non-Locking Fuel Cap .....	10819	
V-12 6.0 L			1995; Regular Locking Fuel Cap .....	10591	
1995; Lev-R-Vent Radiator Cap .....	10330	16	1995; Pre-Vent Locking Fuel Cap .....	10501	
1995; OE Type Radiator Cap .....	10230	16	1995; Oil Filler Cap .....	10066	
<b>XK</b>			<b>Commander</b>		
V-8 4.2 L			V-6 3.7 L		
2009-2007; OE Type Radiator Cap .....	10238	16	2010-2009; Lev-R-Vent Radiator Cap .....	10334	18
<b>XK8</b>			2010-2009; OE Type Radiator Cap .....	10234	18
V-8 4.0 L			2010-2009; OE Equivalent Fuel Cap .....	10838	
2002-1997; OE Type Radiator Cap .....	10263	15	2010-2009; Regular Locking Fuel Cap .....	10508	
V-8 4.2 L			2010-2009; Oil Filler Cap .....	10120	
2006; OE Type Radiator Cap .....	10263	15	2008; Lev-R-Vent Radiator Cap .....	10334	18
2004-2003; OE Type Radiator Cap .....	10263	15	2008; OE Type Radiator Cap .....	10234	18
<b>XKR</b>			2008; OE Equivalent Fuel Cap .....	10838	
V-8 4.0 L			2008; Regular Locking Fuel Cap .....	10508	
2002-2000; OE Type Radiator Cap .....	10263	15	2007-2006; Lev-R-Vent Radiator Cap .....	10334	18
V-8 4.2 L			2007-2006; OE Type Radiator Cap .....	10234	18
2009-2007; OE Type Radiator Cap .....	10238	16	2007-2006; OE Equivalent Fuel Cap .....	10838	
2006-2003; OE Type Radiator Cap .....	10263	15	2007-2006; Regular Locking Fuel Cap .....	10508	
<b>Jeep</b>			2007-2006; Oil Filler Cap .....	10120	
<b>Cherokee</b>			V-8 4.7 L		
4-Cyl. 2.5 L			2009; Lev-R-Vent Radiator Cap .....	10334	18
2000; Lev-R-Vent Radiator Cap .....	10331	16	2009; OE Type Radiator Cap .....	10234	18
2000; OE Type Radiator Cap .....	10231	16	2009; OE Equivalent Fuel Cap .....	10838	
2000; OE Equivalent Fuel Cap .....	10838		2009; Regular Locking Fuel Cap .....	10508	
2000; Regular Locking Fuel Cap .....	10508		2009; Oil Filler Cap .....	10120	
2000; Oil Filler Cap .....	10066		2008; Lev-R-Vent Radiator Cap .....	10334	18
1999; Lev-R-Vent Radiator Cap .....	10331	16	2008; OE Type Radiator Cap .....	10234	18
1999; OE Type Radiator Cap .....	10231	16	2008; OE Equivalent Fuel Cap .....	10838	
1999; OE Equivalent Fuel Cap .....	10817		2008; Regular Locking Fuel Cap .....	10508	
1999; Pre-Vent Non-Locking Fuel Cap .....	10819		2007-2006; Lev-R-Vent Radiator Cap .....	10334	18
1999; Regular Locking Fuel Cap .....	10591		2007-2006; OE Type Radiator Cap .....	10234	18
1999; Pre-Vent Locking Fuel Cap .....	10501		2007-2006; OE Equivalent Fuel Cap .....	10838	
1999; Oil Filler Cap .....	10066		2007-2006; Regular Locking Fuel Cap .....	10508	
1998; Lev-R-Vent Radiator Cap .....	10331	16	2007-2006; Oil Filler Cap .....	10120	
1998; OE Type Radiator Cap .....	10231	16	V-8 5.7 L		
1998; OE Equivalent Fuel Cap .....	10817		2010-2006; Lev-R-Vent Radiator Cap .....	10334	18
1998; Pre-Vent Non-Locking Fuel Cap .....	10819		2010-2006; OE Type Radiator Cap .....	10234	18
1998; Regular Locking Fuel Cap .....	10591		2010-2006; OE Equivalent Fuel Cap .....	10838	
1998; Pre-Vent Locking Fuel Cap .....	10501		2010-2006; Regular Locking Fuel Cap .....	10508	
1998; Oil Filler Cap .....	10111		2010-2006; Oil Filler Cap .....	10111	
1997-1995; Lev-R-Vent Radiator Cap .....	10331	16	<b>Compass</b>		
1997-1995; OE Type Radiator Cap .....	10231	16	4-Cyl. 2.0 L		
1997-1995; OE Equivalent Fuel Cap .....	10817		2011; OE Type Radiator Cap .....	10230	16
1997-1995; Pre-Vent Non-Locking Fuel Cap .....	10819		2011; Lev-R-Vent Radiator Cap .....	10330	16
1997-1995; Regular Locking Fuel Cap .....	10591		2011; OE Equivalent Fuel Cap .....	10838	
1997-1995; Pre-Vent Locking Fuel Cap .....	10501		2011; Regular Locking Fuel Cap .....	10508	
1997-1995; Oil Filler Cap .....	10066		2010-2007; OE Equivalent Fuel Cap .....	10838	
6-Cyl. 4.0 L			2010-2007; Regular Locking Fuel Cap .....	10508	
2001-2000; Lev-R-Vent Radiator Cap .....	10331	16	2010-2007; Oil Filler Cap .....	10111	
			4-Cyl. 2.4 L		
			2011; OE Type Radiator Cap .....	10230	16
			2011; Lev-R-Vent Radiator Cap .....	10330	16
			2011; OE Equivalent Fuel Cap .....	10838	
			2011; Regular Locking Fuel Cap .....	10508	
			2010-2008; OE Equivalent Fuel Cap .....	10838	

## Caps for Passenger Cars and Light Trucks (1990 and Newer)

Application	Part Number	PSI	Application	Part Number	PSI
<b>Jeep - Continued</b>			<b>Jeep - Continued</b>		
<b>Compass - Continued</b>			<b>Grand Cherokee - Continued</b>		
<b>4-Cyl. 2.4 L - Continued</b>			<b>V-8 4.7 L - Continued</b>		
2010-2008; Regular Locking Fuel Cap .....	10508		2009-2008; OE Type Radiator Cap .....	10234	18
2010-2008; Oil Filler Cap .....	10111		2009-2008; OE Equivalent Fuel Cap .....	10838	
2007; Lev-R-Vent Radiator Cap .....	10330	16	2009-2008; Regular Locking Fuel Cap .....	10508	
2007; OE Type Radiator Cap .....	10230	16	2009-2008; Oil Filler Cap .....	10120	
2007; OE Equivalent Fuel Cap .....	10838		2007; Lev-R-Vent Radiator Cap .....	10334	18
2007; Regular Locking Fuel Cap .....	10508		2007; OE Type Radiator Cap .....	10234	18
2007; Oil Filler Cap .....	10111		2007; OE Equivalent Fuel Cap; Eng. VIN N .....	10838	
<b>Grand Cherokee</b>			2007; Regular Locking Fuel Cap; Eng. VIN N .....	10508	
<b>6-Cyl. 4.0 L</b>			2007; OE Equivalent Fuel Cap; Eng. VIN P .....	10838	
2004-2001; Lev-R-Vent Radiator Cap .....	10334	18	2007; Regular Locking Fuel Cap; Eng. VIN P .....	10508	
2004-2001; OE Type Radiator Cap .....	10234	18	2007; Flex Fuel Regular Fuel Cap; Eng. VIN P .....	10838Y	
2004-2001; OE Equivalent Fuel Cap .....	10838		2007; Flex Fuel Regular Locking Fuel Cap; Eng. VIN P .....	10508Y	
2004-2001; Regular Locking Fuel Cap .....	10508		2007; Oil Filler Cap .....	10120	
2004-2001; Oil Filler Cap .....	10111		2006-2003; Lev-R-Vent Radiator Cap .....	10334	18
2000-1997; Lev-R-Vent Radiator Cap .....	10334	18	2006-2003; OE Type Radiator Cap .....	10234	18
2000-1997; OE Type Radiator Cap .....	10234	18	2006-2003; OE Equivalent Fuel Cap .....	10838	
2000-1997; OE Equivalent Fuel Cap .....	10817		2006-2003; Regular Locking Fuel Cap .....	10508	
2000-1997; Pre-Vent Non-Locking Fuel Cap .....	10819		2006-2003; Oil Filler Cap .....	10120	
2000-1997; Regular Locking Fuel Cap .....	10591		2002-2001; Lev-R-Vent Radiator Cap .....	10335	20
2000-1997; Pre-Vent Locking Fuel Cap .....	10501		2002-2001; OE Type Radiator Cap .....	10235	20
2000-1997; Oil Filler Cap .....	10111		2002-2001; OE Equivalent Fuel Cap .....	10838	
1996; Lev-R-Vent Radiator Cap .....	10331	16	2002-2001; Regular Locking Fuel Cap .....	10508	
1996; OE Type Radiator Cap .....	10231	16	2002-2001; Oil Filler Cap .....	10120	
1996; OE Equivalent Fuel Cap .....	10817		2000-1999; Lev-R-Vent Radiator Cap .....	10335	20
1996; Pre-Vent Non-Locking Fuel Cap .....	10819		2000-1999; OE Type Radiator Cap .....	10235	20
1996; Regular Locking Fuel Cap .....	10591		2000-1999; OE Equivalent Fuel Cap .....	10817	
1996; Pre-Vent Locking Fuel Cap .....	10501		2000-1999; Pre-Vent Non-Locking Fuel Cap .....	10819	
1996; Oil Filler Cap .....	10111		2000-1999; Regular Locking Fuel Cap .....	10591	
1995; Lev-R-Vent Radiator Cap .....	10331	16	2000-1999; Pre-Vent Locking Fuel Cap .....	10501	
1995; OE Type Radiator Cap .....	10231	16	2000-1999; Oil Filler Cap .....	10120	
1995; OE Equivalent Fuel Cap .....	10817		<b>V-8 5.2 L</b>		
1995; Pre-Vent Non-Locking Fuel Cap .....	10819		1998; Lev-R-Vent Radiator Cap .....	10334	18
1995; Regular Locking Fuel Cap .....	10591		1998; OE Type Radiator Cap .....	10234	18
1995; Pre-Vent Locking Fuel Cap .....	10501		1998; OE Equivalent Fuel Cap .....	10817	
1995; Oil Filler Cap .....	10066		1998; Pre-Vent Non-Locking Fuel Cap .....	10819	
<b>V-6 3.0 L Diesel</b>			1998; Regular Locking Fuel Cap .....	10591	
2009-2008; Lev-R-Vent Radiator Cap .....	10334	18	1998; Pre-Vent Locking Fuel Cap .....	10501	
2009-2008; OE Type Radiator Cap .....	10234	18	1998; Oil Filler Cap .....	10111	
2009-2008; OE Equivalent Fuel Cap .....	10838		1997-1995; Lev-R-Vent Radiator Cap .....	10334	18
2009-2008; Diesel Regular Non-Locking Fuel Cap .....	10838D		1997-1995; OE Type Radiator Cap .....	10234	18
2009-2008; Regular Locking Fuel Cap .....	10508		1997-1995; OE Equivalent Fuel Cap .....	10817	
2009-2008; Diesel Regular Locking Fuel Cap .....	10508D		1997-1995; Pre-Vent Non-Locking Fuel Cap .....	10819	
2007; Lev-R-Vent Radiator Cap .....	10334	18	1997-1995; Regular Locking Fuel Cap .....	10591	
2007; OE Type Radiator Cap .....	10234	18	1997-1995; Pre-Vent Locking Fuel Cap .....	10501	
2007; OE Equivalent Fuel Cap .....	10838		1997-1995; Oil Filler Cap .....	10111	
2007; Diesel Regular Non-Locking Fuel Cap .....	10838D		1997-1995; Oil Breather Cap .....	10075	
2007; Regular Locking Fuel Cap .....	10508		<b>V-8 5.7 L</b>		
2007; Diesel Regular Locking Fuel Cap .....	10508D		2012-2011; OE Equivalent Fuel Cap .....	10838	
2007; Oil Filler Cap .....	10130		2012-2011; Regular Locking Fuel Cap .....	10508	
<b>V-6 3.6 L</b>			2010-2005; Lev-R-Vent Radiator Cap .....	10334	18
2012-2011; OE Equivalent Fuel Cap .....	10838		2010-2005; OE Type Radiator Cap .....	10234	18
2012-2011; Flex Fuel Regular Fuel Cap .....	10838Y		2010-2005; OE Equivalent Fuel Cap .....	10838	
2012-2011; Regular Locking Fuel Cap .....	10508		2010-2005; Regular Locking Fuel Cap .....	10508	
2012-2011; Flex Fuel Regular Locking Fuel Cap .....	10508Y		2010-2005; Oil Filler Cap .....	10111	
<b>V-6 3.7 L</b>			<b>V-8 5.9 L</b>		
2010-2009; Lev-R-Vent Radiator Cap .....	10334	18	1998; Lev-R-Vent Radiator Cap .....	10334	18
2010-2009; OE Type Radiator Cap .....	10234	18	1998; OE Type Radiator Cap .....	10234	18
2010-2009; OE Equivalent Fuel Cap .....	10838		1998; OE Equivalent Fuel Cap .....	10817	
2010-2009; Regular Locking Fuel Cap .....	10508		1998; Pre-Vent Non-Locking Fuel Cap .....	10819	
2010-2009; Oil Filler Cap .....	10120		1998; Regular Locking Fuel Cap .....	10591	
2008; Lev-R-Vent Radiator Cap .....	10334	18	1998; Pre-Vent Locking Fuel Cap .....	10501	
2008; OE Type Radiator Cap .....	10234	18	1998; Oil Filler Cap .....	10111	
2008; OE Equivalent Fuel Cap .....	10838		<b>V-8 6.1 L</b>		
2008; Regular Locking Fuel Cap .....	10508		2010-2006; Lev-R-Vent Radiator Cap .....	10334	18
2007-2005; Lev-R-Vent Radiator Cap .....	10334	18	2010-2006; OE Type Radiator Cap .....	10234	18
2007-2005; OE Type Radiator Cap .....	10234	18	2010-2006; OE Equivalent Fuel Cap .....	10838	
2007-2005; OE Equivalent Fuel Cap .....	10838		2010-2006; Regular Locking Fuel Cap .....	10508	
2007-2005; Regular Locking Fuel Cap .....	10508		2010-2006; Oil Filler Cap .....	10111	
2007-2005; Oil Filler Cap .....	10120		<b>Liberty</b>		
<b>V-8 4.7 L</b>			<b>4-Cyl. 2.4 L</b>		
2009-2008; Lev-R-Vent Radiator Cap .....	10334	18	2005-2002; Lev-R-Vent Radiator Cap .....	10334	18

## Caps for Passenger Cars and Light Trucks (1990 and Newer)

Application	Part Number	PSI	Application	Part Number	PSI
<b>Jeep - Continued</b>			<b>Jeep - Continued</b>		
<b>Liberty - Continued</b>			<b>TJ - Continued</b>		
<b>4-Cyl. 2.4 L - Continued</b>			<b>4-Cyl. 2.5 L (Canada) - Continued</b>		
2005-2002: OE Type Radiator Cap .....	10234	18	2002: OE Equivalent Fuel Cap .....	10838	
2005-2002: OE Equivalent Fuel Cap .....	10838		2002: Regular Locking Fuel Cap .....	10508	
2005-2002: Regular Locking Fuel Cap .....	10508		2002: Oil Filler Cap .....	10066	
2005-2002: Oil Filler Cap .....	10111		2001-2000: Lev-R-Vent Radiator Cap .....	10334	18
<b>4-Cyl. 2.8 L Diesel</b>			2001-2000: OE Type Radiator Cap .....	10234	18
2006-2005: Lev-R-Vent Radiator Cap .....	10330	16	2001-2000: OE Equivalent Fuel Cap .....	10817	
2006-2005: OE Type Radiator Cap .....	10230	16	2001-2000: Pre-Vent Non-Locking Fuel Cap .....	10819	
2006-2005: OE Equivalent Fuel Cap .....	10838		2001-2000: Regular Locking Fuel Cap .....	10591	
2006-2005: Diesel Regular Non-Locking Fuel Cap .....	10838D		2001-2000: Pre-Vent Locking Fuel Cap .....	10501	
2006-2005: Regular Locking Fuel Cap .....	10508		2001-2000: Oil Filler Cap .....	10066	
2006-2005: Diesel Regular Locking Fuel Cap .....	10508D		1999: Lev-R-Vent Radiator Cap .....	10331	16
2006-2005: Oil Filler Cap .....	10081		1999: OE Type Radiator Cap .....	10231	16
<b>V-6 3.7 L</b>			1999: OE Equivalent Fuel Cap .....	10817	
2012-2011: OE Equivalent Fuel Cap .....	10838		1999: Pre-Vent Non-Locking Fuel Cap .....	10819	
2012-2011: Regular Locking Fuel Cap .....	10508		1999: Regular Locking Fuel Cap .....	10591	
2010-2009: Lev-R-Vent Radiator Cap .....	10334	18	1999: Pre-Vent Locking Fuel Cap .....	10501	
2010-2009: OE Type Radiator Cap .....	10234	18	1999: Oil Filler Cap .....	10066	
2010-2009: OE Equivalent Fuel Cap .....	10838		1998-1997: Lev-R-Vent Radiator Cap .....	10334	18
2010-2009: Regular Locking Fuel Cap .....	10508		1998-1997: OE Type Radiator Cap .....	10234	18
2010-2009: Oil Filler Cap .....	10120		1998-1997: OE Equivalent Fuel Cap .....	10817	
2008: Lev-R-Vent Radiator Cap .....	10334	18	1998-1997: Pre-Vent Non-Locking Fuel Cap .....	10819	
2008: OE Type Radiator Cap .....	10234	18	1998-1997: Regular Locking Fuel Cap .....	10591	
2008: OE Equivalent Fuel Cap .....	10838		1998-1997: Pre-Vent Locking Fuel Cap .....	10501	
2008: Regular Locking Fuel Cap .....	10508		1998-1997: Oil Filler Cap .....	10066	
2007: Lev-R-Vent Radiator Cap .....	10334	18	<b>6-Cyl. 4.0 L (Canada)</b>		
2007: OE Type Radiator Cap .....	10234	18	2006-2001: Lev-R-Vent Radiator Cap .....	10334	18
2007: OE Equivalent Fuel Cap .....	10838		2006-2001: OE Type Radiator Cap .....	10234	18
2007: Regular Locking Fuel Cap .....	10508		2006-2001: OE Equivalent Fuel Cap .....	10838	
2007: Oil Filler Cap .....	10120		2006-2001: Regular Locking Fuel Cap .....	10508	
2006-2003: Lev-R-Vent Radiator Cap .....	10330	16	2006-2001: Oil Filler Cap .....	10111	
2006-2003: OE Type Radiator Cap .....	10230	16	2000-1997: Lev-R-Vent Radiator Cap .....	10334	18
2006-2003: OE Equivalent Fuel Cap .....	10838		2000-1997: OE Type Radiator Cap .....	10234	18
2006-2003: Regular Locking Fuel Cap .....	10508		2000-1997: OE Equivalent Fuel Cap .....	10817	
2006-2003: Oil Filler Cap .....	10120		2000-1997: Pre-Vent Non-Locking Fuel Cap .....	10819	
2002: Lev-R-Vent Radiator Cap .....	10334	18	2000-1997: Regular Locking Fuel Cap .....	10591	
2002: OE Type Radiator Cap .....	10234	18	2000-1997: Pre-Vent Locking Fuel Cap .....	10501	
2002: OE Equivalent Fuel Cap .....	10838		2000-1997: Oil Filler Cap .....	10111	
2002: Regular Locking Fuel Cap .....	10508		<b>Wrangler</b>		
2002: Oil Filler Cap .....	10120		<b>4-Cyl. 2.4 L</b>		
<b>Patriot</b>			2006-2003: Lev-R-Vent Radiator Cap .....	10334	18
<b>4-Cyl. 2.0 L</b>			2006-2003: OE Type Radiator Cap .....	10234	18
2011: OE Type Radiator Cap .....	10230	16	2006-2003: OE Equivalent Fuel Cap .....	10838	
2011: Lev-R-Vent Radiator Cap .....	10330	16	2006-2003: Regular Locking Fuel Cap .....	10508	
2011: OE Equivalent Fuel Cap .....	10838		2006-2003: Oil Filler Cap .....	10111	
2011: Regular Locking Fuel Cap .....	10508		<b>4-Cyl. 2.5 L</b>		
2010: OE Equivalent Fuel Cap .....	10838		2002: Lev-R-Vent Radiator Cap .....	10334	18
2010: Regular Locking Fuel Cap .....	10508		2002: OE Type Radiator Cap .....	10234	18
2009-2008: OE Equivalent Fuel Cap .....	10838		2002: OE Equivalent Fuel Cap .....	10838	
2009-2008: Regular Locking Fuel Cap .....	10508		2002: Regular Locking Fuel Cap .....	10508	
2009-2008: Oil Filler Cap .....	10111		2002: Oil Filler Cap .....	10066	
2007: OE Equivalent Fuel Cap .....	10838		2001-2000: Lev-R-Vent Radiator Cap .....	10334	18
2007: Regular Locking Fuel Cap .....	10508		2001-2000: OE Type Radiator Cap .....	10234	18
<b>4-Cyl. 2.4 L</b>			2001-2000: OE Equivalent Fuel Cap .....	10817	
2011: OE Type Radiator Cap .....	10230	16	2001-2000: Pre-Vent Non-Locking Fuel Cap .....	10819	
2011: Lev-R-Vent Radiator Cap .....	10330	16	2001-2000: Regular Locking Fuel Cap .....	10591	
2011: OE Equivalent Fuel Cap .....	10838		2001-2000: Pre-Vent Locking Fuel Cap .....	10501	
2011: Regular Locking Fuel Cap .....	10508		2001-2000: Oil Filler Cap .....	10066	
2010-2007: OE Equivalent Fuel Cap .....	10838		1999: Lev-R-Vent Radiator Cap .....	10331	16
2010-2007: Regular Locking Fuel Cap .....	10508		1999: OE Type Radiator Cap .....	10231	16
2010-2007: Oil Filler Cap .....	10111		1999: OE Equivalent Fuel Cap .....	10817	
<b>TJ</b>			1999: Pre-Vent Non-Locking Fuel Cap .....	10819	
<b>4-Cyl. 2.4 L (Canada)</b>			1999: Regular Locking Fuel Cap .....	10591	
2006-2003: Lev-R-Vent Radiator Cap .....	10334	18	1999: Pre-Vent Locking Fuel Cap .....	10501	
2006-2003: OE Type Radiator Cap .....	10234	18	1999: Oil Filler Cap .....	10066	
2006-2003: OE Equivalent Fuel Cap .....	10838		1998-1997: Lev-R-Vent Radiator Cap .....	10334	18
2006-2003: Regular Locking Fuel Cap .....	10508		1998-1997: OE Type Radiator Cap .....	10234	18
2006-2003: Oil Filler Cap .....	10111		1998-1997: OE Equivalent Fuel Cap .....	10817	
<b>4-Cyl. 2.5 L (Canada)</b>			1998-1997: Pre-Vent Non-Locking Fuel Cap .....	10819	
2002: Lev-R-Vent Radiator Cap .....	10334	18	1998-1997: Regular Locking Fuel Cap .....	10591	
2002: OE Type Radiator Cap .....	10234	18	1998-1997: Pre-Vent Locking Fuel Cap .....	10501	
			1998-1997: Oil Filler Cap .....	10066	

## Caps for Passenger Cars and Light Trucks (1990 and Newer)

Application	Part Number	PSI	Application	Part Number	PSI
<b>Jeep - Continued</b>			<b>Kia - Continued</b>		
<b>Wrangler - Continued</b>			<b>Borrego - Continued</b>		
<b>4-Cyl. 2.5 L - Continued</b>			<b>V-6 3.8 L - Continued</b>		
1995; Lev-R-Vent Radiator Cap .....	10331	16	2009; Regular Locking Fuel Cap .....	10512	
1995; OE Type Radiator Cap .....	10231	16	2009; Oil Filler Cap .....	10081	
1995; OE Equivalent Fuel Cap .....	10817		<b>V-8 4.6 L</b>		
1995; Pre-Vent Non-Locking Fuel Cap .....	10819		2009; Lev-R-Vent Radiator Cap .....	✓10333	16
1995; Regular Locking Fuel Cap .....	10591		2009; OE Type Radiator Cap .....	10233	16
1995; Pre-Vent Locking Fuel Cap .....	10501		2009; OE Equivalent Fuel Cap .....	10842	
1995; Oil Filler Cap .....	10066		2009; Regular Locking Fuel Cap .....	10512	
<b>6-Cyl. 4.0 L</b>			2009; Oil Filler Cap .....	10082	
2006-2001; Lev-R-Vent Radiator Cap .....	10334	18	<b>Forte</b>		
2006-2001; OE Type Radiator Cap .....	10234	18	<b>4-Cyl. 2.0 L</b>		
2006-2001; OE Equivalent Fuel Cap .....	10838		2011; Lev-R-Vent Radiator Cap .....	10333	16
2006-2001; Regular Locking Fuel Cap .....	10508		2011; OE Type Radiator Cap .....	10233	16
2006-2001; Oil Filler Cap .....	10111		2011; OE Equivalent Fuel Cap .....	10842	
2000-1997; Lev-R-Vent Radiator Cap .....	10334	18	2011; Regular Locking Fuel Cap .....	10512	
2000-1997; OE Type Radiator Cap .....	10234	18	2011; Oil Filler Cap .....	10081	
2000-1997; OE Equivalent Fuel Cap .....	10817		2010; Lev-R-Vent Radiator Cap .....	10333	16
2000-1997; Pre-Vent Non-Locking Fuel Cap .....	10819		2010; OE Type Radiator Cap .....	10233	16
2000-1997; Regular Locking Fuel Cap .....	10591		2010; OE Equivalent Fuel Cap .....	10842	
2000-1997; Pre-Vent Locking Fuel Cap .....	10501		2010; Regular Locking Fuel Cap .....	10512	
2000-1997; Oil Filler Cap .....	10111		<b>4-Cyl. 2.4 L</b>		
1995; Lev-R-Vent Radiator Cap .....	10331	16	2011-2010; Lev-R-Vent Radiator Cap .....	10333	16
1995; OE Type Radiator Cap .....	10231	16	2011-2010; OE Type Radiator Cap .....	10233	16
1995; OE Equivalent Fuel Cap .....	10817		2011-2010; OE Equivalent Fuel Cap .....	10842	
1995; Pre-Vent Non-Locking Fuel Cap .....	10819		2011-2010; Regular Locking Fuel Cap .....	10512	
1995; Regular Locking Fuel Cap .....	10591		2011-2010; Oil Filler Cap .....	10081	
1995; Pre-Vent Locking Fuel Cap .....	10501		<b>Magentis</b>		
1995; Oil Filler Cap .....	10066		<b>4-Cyl. 2.4 L (Canada)</b>		
<b>V-6 3.6 L</b>			2009; Lev-R-Vent Radiator Cap .....	✓10333	16
2012; OE Equivalent Fuel Cap .....	10838		2009; OE Type Radiator Cap .....	10233	16
2012; Flex Fuel Regular Fuel Cap .....	10838Y		2009; OE Equivalent Fuel Cap .....	10842	
2012; Regular Locking Fuel Cap .....	10508		2009; Regular Locking Fuel Cap .....	10512	
2012; Flex Fuel Regular Locking Fuel Cap .....	10508Y		2009; Oil Filler Cap .....	10081	
<b>V-6 3.8 L</b>			2009; OE Equivalent Fuel Cap .....	10842	
2011; OE Equivalent Fuel Cap .....	10838		2008; Regular Locking Fuel Cap .....	10512	
2011; Regular Locking Fuel Cap .....	10508		2008; Oil Filler Cap .....	10081	
2010-2007; Lev-R-Vent Radiator Cap .....	10334	18	2008; Regular Locking Fuel Cap .....	✓10333	16
2010-2007; OE Type Radiator Cap .....	10234	18	2007; Lev-R-Vent Radiator Cap .....	10233	16
2010-2007; OE Equivalent Fuel Cap .....	10838		2007; OE Type Radiator Cap .....	10842	
2010-2007; Regular Locking Fuel Cap .....	10508		2007; OE Equivalent Fuel Cap .....	10842	
2010-2007; Oil Filler Cap .....	10111		2007; Regular Locking Fuel Cap .....	10512	
<b>YJ</b>			2007; Oil Filler Cap .....	10081	
<b>4-Cyl. 2.5 L (Canada); 6-Cyl. 4.0 L (Canada)</b>			2006; Lev-R-Vent Radiator Cap .....	✓10333	16
1995; Lev-R-Vent Radiator Cap .....	10331	16	2006; OE Type Radiator Cap .....	10233	16
1995; OE Type Radiator Cap .....	10231	16	2006; OE Equivalent Fuel Cap .....	10842	
1995; OE Equivalent Fuel Cap .....	10817		2006; Regular Locking Fuel Cap .....	10512	
1995; Pre-Vent Non-Locking Fuel Cap .....	10819		2006; Oil Filler Cap .....	10082	
1995; Regular Locking Fuel Cap .....	10591		2005; OE Equivalent Fuel Cap .....	10825	
1995; Pre-Vent Locking Fuel Cap .....	10501		2005; Regular Locking Fuel Cap .....	10595	
1995; Oil Filler Cap .....	10066		2004-2003; Lev-R-Vent Radiator Cap .....	✓10333	16
<b>Kia</b>			2004-2003; OE Type Radiator Cap .....	10233	16
<b>Amanti</b>			2004-2003; OE Equivalent Fuel Cap .....	10825	
<b>V-6 3.5 L</b>			2004-2003; Regular Locking Fuel Cap .....	10595	
2006-2004; Lev-R-Vent Radiator Cap .....	✓10333	16	2004-2003; Oil Filler Cap .....	10082	
2006-2004; OE Type Radiator Cap .....	10233	16	2002; Lev-R-Vent Radiator Cap .....	✓10333	16
2006-2004; OE Equivalent Fuel Cap .....	10825		2002; OE Type Radiator Cap .....	10233	16
2006-2004; Regular Locking Fuel Cap .....	10595		2002; OE Equivalent Fuel Cap .....	10825	
2006-2004; Oil Filler Cap .....	10088		2002; Regular Locking Fuel Cap .....	10595	
<b>V-6 3.8 L</b>			2002; Oil Filler Cap .....	10138	
2009-2007; Lev-R-Vent Radiator Cap .....	✓10333	16	2001; Lev-R-Vent Radiator Cap .....	✓10333	16
2009-2007; OE Type Radiator Cap .....	10233	16	2001; OE Type Radiator Cap .....	10233	16
2009-2007; OE Equivalent Fuel Cap .....	10842		2001; OE Equivalent Fuel Cap .....	10817	
2009-2007; Regular Locking Fuel Cap .....	10512		2001; Pre-Vent Non-Locking Fuel Cap .....	10819	
2009-2007; Oil Filler Cap .....	10081		2001; Regular Locking Fuel Cap .....	10591	
<b>Borrego</b>			2001; Pre-Vent Locking Fuel Cap .....	10501	
<b>V-6 3.8 L</b>			2001; Oil Filler Cap .....	10138	
2009; Lev-R-Vent Radiator Cap .....	✓10333	16	<b>V-6 2.5 L (Canada)</b>		
2009; OE Type Radiator Cap .....	10233	16	2001; Lev-R-Vent Radiator Cap .....	✓10333	16
2009; OE Equivalent Fuel Cap .....	10842		2001; OE Type Radiator Cap .....	10233	16
			2001; OE Equivalent Fuel Cap .....	10825	
			2001; Regular Locking Fuel Cap .....	10595	
			2001; Oil Filler Cap .....	10143	

✓ Check Hood Clearance prior to installing this Cap.

## Caps for Passenger Cars and Light Trucks (1990 and Newer)

Application	Part Number	PSI	Application	Part Number	PSI
<b>Kia - Continued</b>			<b>Kia - Continued</b>		
<b>Magentis - Continued</b>			<b>Optima - Continued</b>		
<b>V-6 2.7 L (Canada)</b>			<b>V-6 2.7 L</b>		
2009: OE Equivalent Fuel Cap .....	10842		2010: Lev-R-Vent Radiator Cap .....	10333	16
2009: Regular Locking Fuel Cap .....	10512		2010: OE Type Radiator Cap .....	10233	16
2009: Oil Filler Cap .....	10081		2010: OE Equivalent Fuel Cap .....	10842	
2008: Oil Filler Cap .....	10081		2010: Regular Locking Fuel Cap .....	10512	
2007: Lev-R-Vent Radiator Cap .....	✓10333	16	2009: Lev-R-Vent Radiator Cap .....	✓10333	16
2007: OE Type Radiator Cap .....	10233	16	2009: OE Type Radiator Cap .....	10233	16
2007: OE Equivalent Fuel Cap .....	10842		2009: OE Equivalent Fuel Cap .....	10842	
2007: Regular Locking Fuel Cap .....	10512		2009: Regular Locking Fuel Cap .....	10512	
2007: Oil Filler Cap .....	10081		2009: Oil Filler Cap .....	10081	
2006: Lev-R-Vent Radiator Cap .....	✓10333	16	2008: Lev-R-Vent Radiator Cap .....	✓10333	16
2006: OE Type Radiator Cap .....	10233	16	2008: OE Type Radiator Cap .....	10233	16
2006: OE Equivalent Fuel Cap .....	10842		2008: Oil Filler Cap .....	10081	
2006: Regular Locking Fuel Cap .....	10512		2007: Lev-R-Vent Radiator Cap .....	✓10333	16
2006: Oil Filler Cap .....	10143		2007: OE Type Radiator Cap .....	10233	16
2005-2002: Lev-R-Vent Radiator Cap .....	✓10333	16	2007: OE Equivalent Fuel Cap .....	10842	
2005-2002: OE Type Radiator Cap .....	10233	16	2007: Regular Locking Fuel Cap .....	10512	
2005-2002: OE Equivalent Fuel Cap .....	10825		2007: Oil Filler Cap .....	10081	
2005-2002: Regular Locking Fuel Cap .....	10595		2006: Lev-R-Vent Radiator Cap .....	✓10333	16
2005-2002: Oil Filler Cap .....	10143		2006: OE Type Radiator Cap .....	10233	16
<b>Optima</b>			<b>Rio</b>		
<b>4-Cyl. 2.0 L</b>			<b>4-Cyl. 1.5 L</b>		
2011: Lev-R-Vent Radiator Cap .....	10333	16	2002-2001: Lev-R-Vent Radiator Cap .....	✓10327	13
2011: OE Type Radiator Cap .....	10233	16	2002-2001: OE Type Radiator Cap .....	10227	13
2011: OE Equivalent Fuel Cap .....	10842		2002-2001: OE Equivalent Fuel Cap .....	10817	
2011: Regular Locking Fuel Cap .....	10512		2002-2001: Pre-Vent Non-Locking Fuel Cap .....	10819	
2011: Oil Filler Cap .....	10082		2002-2001: Regular Locking Fuel Cap .....	10591	
<b>4-Cyl. 2.4 L</b>			2002-2001: Pre-Vent Locking Fuel Cap .....	10501	
2011-2010: Lev-R-Vent Radiator Cap .....	10333	16	2002-2001: Oil Filler Cap .....	10137	
2011-2010: OE Type Radiator Cap .....	10233	16	<b>4-Cyl. 1.6 L</b>		
2011-2010: OE Equivalent Fuel Cap .....	10842		2011-2010: Lev-R-Vent Radiator Cap .....	10327	13
2011-2010: Regular Locking Fuel Cap .....	10512		2011-2010: OE Type Radiator Cap .....	10227	13
2009: Lev-R-Vent Radiator Cap .....	✓10333	16	2011-2010: OE Equivalent Fuel Cap .....	10842	
2009: OE Type Radiator Cap .....	10233	16	2011-2010: Regular Locking Fuel Cap .....	10512	
2009: OE Equivalent Fuel Cap .....	10842		2009-2006: Lev-R-Vent Radiator Cap .....	✓10327	13
2009: Regular Locking Fuel Cap .....	10512		2009-2006: OE Type Radiator Cap .....	10227	13
2009: Oil Filler Cap .....	10082		2009-2006: OE Equivalent Fuel Cap .....	10842	
2008-2006: Lev-R-Vent Radiator Cap .....	✓10333	16	2009-2006: Regular Locking Fuel Cap .....	10512	
2008-2006: OE Type Radiator Cap .....	10233	16	2009-2006: Oil Filler Cap .....	10081	
2008-2006: OE Equivalent Fuel Cap .....	10842		2005: Lev-R-Vent Radiator Cap .....	✓10333	16
2008-2006: Regular Locking Fuel Cap .....	10512		2005: OE Type Radiator Cap .....	10233	16
2008-2006: Oil Filler Cap .....	10081		2005: OE Equivalent Fuel Cap .....	10842	
2005: Lev-R-Vent Radiator Cap .....	✓10333	16	2005: Regular Locking Fuel Cap .....	10512	
2005: OE Type Radiator Cap .....	10233	16	2005: Oil Filler Cap .....	10137	
2005: OE Equivalent Fuel Cap .....	10825		2004-2003: Lev-R-Vent Radiator Cap .....	✓10333	16
2005: Regular Locking Fuel Cap .....	10595		2004-2003: OE Type Radiator Cap .....	10233	16
2004-2003: Lev-R-Vent Radiator Cap .....	✓10333	16	2004-2003: OE Equivalent Fuel Cap .....	10825	
2004-2003: OE Type Radiator Cap .....	10233	16	2004-2003: Regular Locking Fuel Cap .....	10595	
2004-2003: OE Equivalent Fuel Cap .....	10825		2004-2003: Oil Filler Cap .....	10137	
2004-2003: Regular Locking Fuel Cap .....	10595		<b>Rondo</b>		
2004-2003: Oil Filler Cap .....	10082		<b>4-Cyl. 2.4 L</b>		
2002: Lev-R-Vent Radiator Cap .....	✓10333	16	2010: Lev-R-Vent Radiator Cap .....	10333	16
2002: OE Type Radiator Cap .....	10233	16	2010: OE Type Radiator Cap .....	10233	16
2002: OE Equivalent Fuel Cap .....	10825		2010: OE Equivalent Fuel Cap .....	10842	
2002: Regular Locking Fuel Cap .....	10595		2010: Regular Locking Fuel Cap .....	10512	
2002: Oil Filler Cap .....	10138		2009: Lev-R-Vent Radiator Cap .....	✓10333	16
2001: Lev-R-Vent Radiator Cap .....	✓10333	16	2009: OE Type Radiator Cap .....	10233	16
2001: OE Type Radiator Cap .....	10233	16	2009: OE Equivalent Fuel Cap .....	10842	
2001: OE Equivalent Fuel Cap .....	10817		2009: Regular Locking Fuel Cap .....	10512	
2001: Pre-Vent Non-Locking Fuel Cap .....	10819		2009: Oil Filler Cap .....	10081	
2001: Regular Locking Fuel Cap .....	10591		2008: OE Equivalent Fuel Cap .....	10842	
2001: Pre-Vent Locking Fuel Cap .....	10501		2008: Regular Locking Fuel Cap .....	10512	
2001: Oil Filler Cap .....	10138		2008: Oil Filler Cap .....	10081	
<b>V-6 2.5 L</b>					
2001: Lev-R-Vent Radiator Cap .....	✓10333	16			
2001: OE Type Radiator Cap .....	10233	16			
2001: OE Equivalent Fuel Cap .....	10817				
2001: Pre-Vent Non-Locking Fuel Cap .....	10819				
2001: Regular Locking Fuel Cap .....	10591				
2001: Pre-Vent Locking Fuel Cap .....	10501				
2001: Oil Filler Cap .....	10143				

✓ Check Hood Clearance prior to installing this Cap.



## Caps for Passenger Cars and Light Trucks (1990 and Newer)

Application	Part Number	PSI	Application	Part Number	PSI
<b>Kia - Continued</b>			<b>Kia - Continued</b>		
<b>Rondo - Continued</b>			<b>Sephia - Continued</b>		
<b>4-Cyl. 2.4 L - Continued</b>			<b>4-Cyl. 1.8 L - Continued</b>		
2007; Lev-R-Vent Radiator Cap .....	✓10333	16	2001; Pre-Vent Non-Locking Fuel Cap .....	10819	
2007; OE Type Radiator Cap .....	10233	16	2001; Regular Locking Fuel Cap .....	10591	
2007; OE Equivalent Fuel Cap .....	10842		2001; Pre-Vent Locking Fuel Cap .....	10501	
2007; Regular Locking Fuel Cap .....	10512		2001; Oil Filler Cap .....	10081	
2007; Oil Filler Cap .....	10081		2000-1995; Lev-R-Vent Radiator Cap .....	✓10327	13
<b>V-6 2.7 L</b>			2000-1995; OE Type Radiator Cap .....	10227	13
2010; Lev-R-Vent Radiator Cap .....	10333	16	2000-1995; OE Equivalent Fuel Cap .....	10817	
2010; OE Type Radiator Cap .....	10233	16	2000-1995; Pre-Vent Non-Locking Fuel Cap .....	10819	
2010; OE Equivalent Fuel Cap .....	10842		2000-1995; Regular Locking Fuel Cap .....	10591	
2010; Regular Locking Fuel Cap .....	10512		2000-1995; Pre-Vent Locking Fuel Cap .....	10501	
2009; Lev-R-Vent Radiator Cap .....	✓10333	16	2000-1995; Oil Filler Cap .....	10082	
2009; OE Type Radiator Cap .....	10233	16	<b>Sorento</b>		
2009; OE Equivalent Fuel Cap .....	10842		<b>4-Cyl. 2.4 L</b>		
2009; Regular Locking Fuel Cap .....	10512		2011; Lev-R-Vent Radiator Cap .....	10333	16
2009; Oil Filler Cap .....	10081		2011; OE Type Radiator Cap .....	10233	16
2008-2007; OE Equivalent Fuel Cap .....	10842		2011; OE Equivalent Fuel Cap .....	10842	
2008-2007; Regular Locking Fuel Cap .....	10512		2011; Regular Locking Fuel Cap .....	10512	
2008-2007; Oil Filler Cap .....	10081		2011; Oil Filler Cap .....	10081	
<b>Sedona</b>			<b>V-6 3.3 L</b>		
<b>V-6 3.5 L</b>			2009; OE Equivalent Fuel Cap .....	10842	
2011; Lev-R-Vent Radiator Cap .....	10333	16	2009; Regular Locking Fuel Cap .....	10512	
2011; OE Type Radiator Cap .....	10233	16	2009; Oil Filler Cap .....	10081	
2011; OE Equivalent Fuel Cap .....	10842		2008; Lev-R-Vent Radiator Cap .....	✓10333	16
2011; Regular Locking Fuel Cap .....	10512		2008; OE Type Radiator Cap .....	10233	16
2011; Oil Filler Cap .....	10081		2008; OE Equivalent Fuel Cap .....	10842	
2005; Lev-R-Vent Radiator Cap .....	✓10333	16	2008; Regular Locking Fuel Cap .....	10512	
2005; OE Type Radiator Cap .....	10233	16	2008; Oil Filler Cap .....	10081	
2005; OE Equivalent Fuel Cap; W/Calif. Emission System .....	10842		<b>V-6 3.5 L</b>		
2005; Regular Locking Fuel Cap; W/Calif. Emission System .....	10512		2011; Lev-R-Vent Radiator Cap .....	10333	16
2005; OE Equivalent Fuel Cap; W/O Calif. Emission System .....	10825		2011; OE Type Radiator Cap .....	10233	16
2005; Regular Locking Fuel Cap; W/O Calif. Emission System ..	10595		2011; OE Equivalent Fuel Cap .....	10842	
2005; Oil Filler Cap .....	10088		2011; Regular Locking Fuel Cap .....	10512	
2004-2002; Lev-R-Vent Radiator Cap .....	✓10333	16	2006-2005; Lev-R-Vent Radiator Cap .....	✓10333	16
2004-2002; OE Type Radiator Cap .....	10233	16	2006-2005; OE Type Radiator Cap .....	10233	16
2004-2002; OE Equivalent Fuel Cap .....	10825		2006-2005; OE Equivalent Fuel Cap .....	10842	
2004-2002; Regular Locking Fuel Cap .....	10595		2006-2005; Regular Locking Fuel Cap .....	10512	
2004-2002; Oil Filler Cap .....	10088		2006-2005; Oil Filler Cap .....	10082	
<b>V-6 3.8 L</b>			2004-2003; Lev-R-Vent Radiator Cap .....	✓10333	16
2010; Lev-R-Vent Radiator Cap .....	10333	16	2004-2003; OE Type Radiator Cap .....	10233	16
2010; OE Type Radiator Cap .....	10233	16	2004-2003; OE Equivalent Fuel Cap .....	10825	
2010; OE Equivalent Fuel Cap .....	10842		2004-2003; Regular Locking Fuel Cap .....	10595	
2010; Regular Locking Fuel Cap .....	10512		2004-2003; Oil Filler Cap .....	10082	
2009; Lev-R-Vent Radiator Cap .....	✓10333	16	<b>V-6 3.8 L</b>		
2009; OE Type Radiator Cap .....	10233	16	2009; Lev-R-Vent Radiator Cap .....	10333	16
2009; OE Equivalent Fuel Cap .....	10842		2009; OE Type Radiator Cap .....	10233	16
2009; Regular Locking Fuel Cap .....	10512		2009; OE Equivalent Fuel Cap .....	10842	
2009; Oil Filler Cap .....	10081		2009; Regular Locking Fuel Cap .....	10512	
2008-2007; Lev-R-Vent Radiator Cap .....	10333	16	2009; Oil Filler Cap .....	10081	
2008-2007; OE Type Radiator Cap .....	10233	16	2008-2007; Lev-R-Vent Radiator Cap .....	✓10333	16
2008-2007; OE Equivalent Fuel Cap .....	10842		2008-2007; OE Type Radiator Cap .....	10233	16
2008-2007; Regular Locking Fuel Cap .....	10512		2008-2007; OE Equivalent Fuel Cap .....	10842	
2008-2007; Oil Filler Cap .....	10081		2008-2007; Regular Locking Fuel Cap .....	10512	
2006; Lev-R-Vent Radiator Cap .....	10333	16	2008-2007; Oil Filler Cap .....	10081	
2006; OE Type Radiator Cap .....	10233	16	<b>Soul</b>		
2006; OE Equivalent Fuel Cap .....	10842		<b>4-Cyl. 1.6 L; 4-Cyl. 2.0 L</b>		
2006; Regular Locking Fuel Cap .....	10512		2011-2010; Lev-R-Vent Radiator Cap .....	10333	16
2006; Oil Filler Cap .....	10082		2011-2010; OE Type Radiator Cap .....	10233	16
<b>Sephia</b>			2011-2010; OE Equivalent Fuel Cap .....	10842	
<b>4-Cyl. 1.6 L</b>			2011-2010; Regular Locking Fuel Cap .....	10512	
1997-1995; Lev-R-Vent Radiator Cap .....	✓10327	13	<b>Spectra</b>		
1997-1995; OE Type Radiator Cap .....	10227	13	<b>4-Cyl. 1.8 L</b>		
1997-1995; OE Equivalent Fuel Cap .....	10817		2004-2003; Lev-R-Vent Radiator Cap .....	✓10333	16
1997-1995; Pre-Vent Non-Locking Fuel Cap .....	10819		2004-2003; OE Type Radiator Cap .....	10233	16
1997-1995; Regular Locking Fuel Cap .....	10591		2004-2003; OE Equivalent Fuel Cap .....	10825	
1997-1995; Pre-Vent Locking Fuel Cap .....	10501		2004-2003; Regular Locking Fuel Cap .....	10595	
1997-1995; Oil Filler Cap .....	10082		2004-2003; Oil Filler Cap .....	10081	
<b>4-Cyl. 1.8 L</b>			2002-2001; Lev-R-Vent Radiator Cap .....	✓10327	13
2001; Lev-R-Vent Radiator Cap .....	✓10327	13	2002-2001; OE Type Radiator Cap .....	10227	13
2001; OE Type Radiator Cap .....	10227	13	2002-2001; OE Equivalent Fuel Cap .....	10817	
2001; OE Equivalent Fuel Cap .....	10817				

✓ Check Hood Clearance prior to installing this Cap.

## Caps for Passenger Cars and Light Trucks (1990 and Newer)

Application	Part Number	PSI	Application	Part Number	PSI
<b>Kia - Continued</b>			<b>Kia - Continued</b>		
<b>Spectra - Continued</b>			<b>Sportage - Continued</b>		
<b>4-Cyl. 1.8 L - Continued</b>			<b>V-6 2.7 L - Continued</b>		
2002-2001; Pre-Vent Non-Locking Fuel Cap .....	10819		2006; Oil Filler Cap .....	10082	
2002-2001; Regular Locking Fuel Cap .....	10591		2005; Lev-R-Vent Radiator Cap .....	✓10333	16
2002-2001; Pre-Vent Locking Fuel Cap .....	10501		2005; OE Type Radiator Cap .....	10233	16
2002-2001; Oil Filler Cap .....	10081		2005; OE Equivalent Fuel Cap .....	10842	
2000; Lev-R-Vent Radiator Cap .....	✓10327	13	2005; Regular Locking Fuel Cap .....	10512	
2000; OE Type Radiator Cap .....	10227	13	2005; Oil Filler Cap .....	10143	
2000; OE Equivalent Fuel Cap .....	10817		<b>Land Rover</b>		
2000; Pre-Vent Non-Locking Fuel Cap .....	10819		<b>Defender 90</b>		
2000; Regular Locking Fuel Cap .....	10591		<b>V-8 3.9 L</b>		
2000; Pre-Vent Locking Fuel Cap .....	10501		1995; Pre-Vent Non-Locking Fuel Cap .....	10819	
2000; Oil Filler Cap .....	10082		1995; Pre-Vent Locking Fuel Cap .....	10501	
<b>4-Cyl. 2.0 L</b>			<b>V-8 4.0 L</b>		
2009-2006; Lev-R-Vent Radiator Cap .....	✓10333	16	1997; Pre-Vent Non-Locking Fuel Cap .....	10819	
2009-2006; OE Type Radiator Cap .....	10233	16	1997; Pre-Vent Locking Fuel Cap .....	10501	
2009-2006; OE Equivalent Fuel Cap .....	10842		<b>Discovery</b>		
2009-2006; Regular Locking Fuel Cap .....	10512		<b>V-8 3.9 L</b>		
2009-2006; Oil Filler Cap .....	10081		1995; Pre-Vent Non-Locking Fuel Cap .....	10819	
2005; Lev-R-Vent Radiator Cap .....	✓10333	16	1995; Pre-Vent Locking Fuel Cap .....	10501	
2005; OE Type Radiator Cap .....	10233	16	<b>V-8 4.0 L</b>		
2005; OE Equivalent Fuel Cap .....	10842		2002-2001; OE Type Radiator Cap .....	10246	20
2005; Regular Locking Fuel Cap .....	10512		2000; OE Type Radiator Cap .....	10246	20
2004; Lev-R-Vent Radiator Cap .....	✓10333	16	2000; Pre-Vent Non-Locking Fuel Cap .....	10819	
2004; OE Type Radiator Cap .....	10233	16	2000; Pre-Vent Locking Fuel Cap .....	10501	
2004; OE Equivalent Fuel Cap .....	10842		2000; Oil Filler Cap .....	10147	
2004; Regular Locking Fuel Cap .....	10512		1999; OE Type Radiator Cap .....	10246	20
2004; Oil Filler Cap .....	10081		1999; OE Equivalent Fuel Cap .....	10817	
<b>Sportage</b>			1999; Pre-Vent Non-Locking Fuel Cap .....	10819	
<b>4-Cyl. 2.0 L</b>			1999; Pre-Vent Locking Fuel Cap .....	10501	
2011; OE Equivalent Fuel Cap .....	10842		1999; Regular Locking Fuel Cap .....	10591	
2011; Regular Locking Fuel Cap .....	10512		1999; Oil Filler Cap .....	10147	
2010; Lev-R-Vent Radiator Cap .....	10333	16	1998-1996; Pre-Vent Non-Locking Fuel Cap .....	10819	
2010; OE Type Radiator Cap .....	10233	16	1998-1996; Pre-Vent Locking Fuel Cap .....	10501	
2009-2007; Lev-R-Vent Radiator Cap .....	✓10333	16	1998-1996; Oil Filler Cap .....	10147	
2009-2007; OE Type Radiator Cap .....	10233	16	<b>V-8 4.6 L</b>		
2009-2007; OE Equivalent Fuel Cap .....	10842		2004-2003; OE Type Radiator Cap .....	10246	20
2009-2007; Regular Locking Fuel Cap .....	10512		2004-2003; OE Equivalent Fuel Cap .....	10817	
2009-2007; Oil Filler Cap .....	10081		2004-2003; Pre-Vent Non-Locking Fuel Cap .....	10819	
2006; OE Equivalent Fuel Cap .....	10842		2004-2003; Pre-Vent Locking Fuel Cap .....	10501	
2006; Regular Locking Fuel Cap .....	10512		2004-2003; Regular Locking Fuel Cap .....	10591	
2006; Oil Filler Cap .....	10082		2004-2003; Oil Filler Cap .....	10147	
2005; Lev-R-Vent Radiator Cap .....	✓10333	16	<b>Freelander</b>		
2005; OE Type Radiator Cap .....	10233	16	<b>V-6 2.5 L</b>		
2005; OE Equivalent Fuel Cap .....	10842		2005-2004; OE Type Radiator Cap .....	10238	16
2005; Regular Locking Fuel Cap .....	10512		2005-2004; Oil Filler Cap .....	10081	
2005; Oil Filler Cap .....	10081		2003; OE Type Radiator Cap .....	10238	16
2002-1995; Lev-R-Vent Radiator Cap .....	✓10327	13	2002; Oil Filler Cap .....	10081	
2002-1995; OE Type Radiator Cap .....	10227	13	<b>LR3</b>		
2002-1995; OE Equivalent Fuel Cap .....	10817		<b>V-6 4.0 L</b>		
2002-1995; Pre-Vent Non-Locking Fuel Cap .....	10819		2007-2005; OE Type Radiator Cap .....	10238	16
2002-1995; Regular Locking Fuel Cap .....	10591		2007-2005; OE Equivalent Fuel Cap .....	10851	
2002-1995; Pre-Vent Locking Fuel Cap .....	10501		2007-2005; Regular Locking Fuel Cap .....	10521	
2002-1995; Oil Filler Cap .....	10082		2007-2005; Oil Filler Cap .....	10117	
<b>4-Cyl. 2.4 L</b>			<b>V-8 4.4 L</b>		
2011; Lev-R-Vent Radiator Cap .....	10333	16	2009; OE Type Radiator Cap .....	10238	16
2011; OE Type Radiator Cap .....	10233	16	2009; Oil Filler Cap .....	10117	
2011; OE Equivalent Fuel Cap .....	10842		2008-2005; OE Type Radiator Cap .....	10238	16
2011; Regular Locking Fuel Cap .....	10512		2008-2005; OE Equivalent Fuel Cap .....	10851	
2011; Oil Filler Cap .....	10081		2008-2005; Regular Locking Fuel Cap .....	10521	
<b>V-6 2.7 L</b>			2008-2005; Oil Filler Cap .....	10117	
2010; Lev-R-Vent Radiator Cap .....	10333	16	<b>Range Rover</b>		
2010; OE Type Radiator Cap .....	10233	16	<b>V-8 3.9 L</b>		
2010; Oil Filler Cap .....	10143		1995; Pre-Vent Non-Locking Fuel Cap .....	10819	
2009-2007; Lev-R-Vent Radiator Cap .....	✓10333	16	1995; Pre-Vent Locking Fuel Cap .....	10501	
2009-2007; OE Type Radiator Cap .....	10233	16	<b>V-8 4.0 L</b>		
2009-2007; OE Equivalent Fuel Cap .....	10842		2000; OE Type Radiator Cap .....	10246	20
2009-2007; Regular Locking Fuel Cap .....	10512		2000; OE Equivalent Fuel Cap .....	10817	
2009-2007; Oil Filler Cap .....	10143				
2006; Lev-R-Vent Radiator Cap .....	✓10333	16			
2006; OE Type Radiator Cap .....	10233	16			
2006; OE Equivalent Fuel Cap .....	10842				
2006; Regular Locking Fuel Cap .....	10512				

✓ Check Hood Clearance prior to installing this Cap.

## Caps for Passenger Cars and Light Trucks (1990 and Newer)

Application	Part Number	PSI	Application	Part Number	PSI
<b>Land Rover - Continued</b>			<b>Lexus - Continued</b>		
<b>Range Rover - Continued</b>			<b>ES300 - Continued</b>		
<b>V-8 4.0 L - Continued</b>			<b>V-6 3.0 L - Continued</b>		
2000; Pre-Vent Non-Locking Fuel Cap .....	10819		1996-1995; Oil Filler Cap .....	10113	
2000; Pre-Vent Locking Fuel Cap .....	10501		<b>ES330</b>		
2000; Regular Locking Fuel Cap .....	10591		<b>V-6 3.3 L</b>		
2000; Oil Filler Cap .....	10147		2006-2004; Lev-R-Vent Radiator Cap .....	✓10333	16
1999-1996; OE Type Radiator Cap .....	10246	20	2006-2004; OE Type Radiator Cap .....	10233	16
1999-1996; Pre-Vent Non-Locking Fuel Cap .....	10819		2006-2004; OE Equivalent Fuel Cap .....	10839	
1999-1996; Pre-Vent Locking Fuel Cap .....	10501		2006-2004; Regular Locking Fuel Cap .....	10509	
1999-1996; Oil Filler Cap .....	10147		2006-2004; Oil Filler Cap .....	10121	
1995; OE Type Radiator Cap .....	10246	20	<b>ES350</b>		
1995; Pre-Vent Non-Locking Fuel Cap .....	10819		<b>V-6 3.5 L</b>		
1995; Pre-Vent Locking Fuel Cap .....	10501		2012; OE Equivalent Fuel Cap .....	10834	
<b>V-8 4.2 L</b>			2012; Regular Locking Fuel Cap .....	10504	
2009-2007; OE Type Radiator Cap .....	10238	16	2011-2009; OE Type Radiator Cap .....	10242	16
2009-2007; Oil Filler Cap .....	10117		2011-2009; OE Equivalent Fuel Cap .....	10834	
2006; OE Type Radiator Cap .....	10238	16	2011-2009; Regular Locking Fuel Cap .....	10504	
1995; Pre-Vent Non-Locking Fuel Cap .....	10819		2011-2009; Oil Filler Cap .....	10080	
1995; Pre-Vent Locking Fuel Cap .....	10501		2008-2007; OE Type Radiator Cap .....	10242	16
<b>V-8 4.4 L</b>			2008-2007; OE Equivalent Fuel Cap .....	10834	
2009-2006; OE Type Radiator Cap .....	10238	16	2008-2007; Regular Locking Fuel Cap .....	10504	
2009-2006; Oil Filler Cap .....	10117		2008-2007; Oil Filler Cap .....	10135	
2005-2003; OE Type Radiator Cap .....	10246	20	<b>GS300</b>		
2005-2003; Oil Filler Cap .....	10131		<b>6-Cyl. 3.0 L</b>		
<b>V-8 4.6 L</b>			2005-2000; OE Type Radiator Cap .....	10242	16
2002-2000; OE Type Radiator Cap .....	10246	20	2005-2000; OE Equivalent Fuel Cap .....	10834	
2002-2000; OE Equivalent Fuel Cap .....	10817		2005-2000; Regular Locking Fuel Cap .....	10504	
2002-2000; Pre-Vent Non-Locking Fuel Cap .....	10819		2005-2000; Oil Filler Cap .....	10121	
2002-2000; Pre-Vent Locking Fuel Cap .....	10501		1999; OE Type Radiator Cap .....	10242	16
2002-2000; Regular Locking Fuel Cap .....	10591		1999; OE Equivalent Fuel Cap .....	10825	
2002-2000; Oil Filler Cap .....	10147		1999; Regular Locking Fuel Cap .....	10595	
1999-1996; OE Type Radiator Cap .....	10246	20	1999; Oil Filler Cap .....	10121	
1999-1996; Pre-Vent Non-Locking Fuel Cap .....	10819		1998-1997; OE Type Radiator Cap .....	10241	13
1999-1996; Pre-Vent Locking Fuel Cap .....	10501		1998-1997; OE Equivalent Fuel Cap .....	10825	
1999-1996; Oil Filler Cap .....	10147		1998-1997; Regular Locking Fuel Cap .....	10595	
<b>Lexus</b>			1998-1997; Oil Filler Cap .....	10121	
<b>CT200h</b>			1996-1995; OE Type Radiator Cap .....	10241	13
<b>4-Cyl. 1.8 L Electric Assist</b>			1996-1995; OE Equivalent Fuel Cap .....	10825	
2012; OE Equivalent Fuel Cap .....	10834		1996-1995; Regular Locking Fuel Cap .....	10595	
2012; Regular Locking Fuel Cap .....	10504		1996-1995; Oil Filler Cap .....	10113	
2011; OE Equivalent Fuel Cap .....	10834		<b>V-6 3.0 L</b>		
2011; Regular Locking Fuel Cap .....	10504		2006; OE Type Radiator Cap .....	10242	16
2011; Oil Filler Cap .....	10135		2006; OE Equivalent Fuel Cap .....	10839	
<b>ES300</b>			2006; Regular Locking Fuel Cap .....	10509	
<b>V-6 3.0 L</b>			2006; Oil Filler Cap .....	10135	
2003-2002; Lev-R-Vent Radiator Cap .....	✓10333	16	<b>GS350</b>		
2003-2002; OE Type Radiator Cap .....	10233	16	<b>V-6 3.5 L</b>		
2003-2002; OE Equivalent Fuel Cap .....	10839		2011-2007; OE Type Radiator Cap .....	10242	16
2003-2002; Regular Locking Fuel Cap .....	10509		2011-2007; OE Equivalent Fuel Cap .....	10834	
2003-2002; Oil Filler Cap .....	10121		2011-2007; Regular Locking Fuel Cap .....	10504	
2001; Lev-R-Vent Radiator Cap .....	✓10333	16	2011-2007; Oil Filler Cap .....	10135	
2001; OE Type Radiator Cap .....	10233	16	<b>GS400</b>		
2001; OE Equivalent Fuel Cap .....	10834		<b>V-8 4.0 L</b>		
2001; Regular Locking Fuel Cap .....	10504		2000-1998; OE Type Radiator Cap .....	10242	16
2001; Oil Filler Cap .....	10121		2000-1998; OE Equivalent Fuel Cap .....	10825	
2000; Lev-R-Vent Radiator Cap .....	✓10333	16	2000-1998; Regular Locking Fuel Cap .....	10595	
2000; OE Type Radiator Cap .....	10233	16	2000-1998; Oil Filler Cap .....	10080	
2000; OE Equivalent Fuel Cap .....	10825		<b>GS430</b>		
2000; Regular Locking Fuel Cap .....	10595		<b>V-8 4.3 L</b>		
2000; Oil Filler Cap .....	10121		2007-2006; OE Type Radiator Cap .....	10242	16
1999-1997; Lev-R-Vent Radiator Cap .....	✓10333	16	2007-2006; OE Equivalent Fuel Cap .....	10839	
1999-1997; OE Type Radiator Cap .....	10233	16	2007-2006; Regular Locking Fuel Cap .....	10509	
1999-1997; OE Equivalent Fuel Cap .....	10825		2007-2006; Oil Filler Cap .....	10080	
1999-1997; Regular Locking Fuel Cap .....	10595		2005-2001; OE Type Radiator Cap .....	10242	16
1999-1997; Oil Filler Cap .....	10113		2005-2001; OE Equivalent Fuel Cap .....	10834	
1996-1995; Lev-R-Vent Radiator Cap; Radiator cap located on water outlet housing. ....	✓10333	16	2005-2001; Regular Locking Fuel Cap .....	10504	
1996-1995; OE Type Radiator Cap; Radiator cap located on water outlet housing. ....	10233	16	2005-2001; Oil Filler Cap .....	10080	
1996-1995; OE Equivalent Fuel Cap .....	10825				
1996-1995; Regular Locking Fuel Cap .....	10595				

✓ Check Hood Clearance prior to installing this Cap.

## Caps for Passenger Cars and Light Trucks (1990 and Newer)

Application	Part Number	PSI	Application	Part Number	PSI
<b>Lexus - Continued</b>			<b>Lexus - Continued</b>		
<b>GS450h</b>			<b>IS300 - Continued</b>		
V-6 3.5 L Electric Assist			6-Cyl. 3.0 L - Continued		
2011; OE Type Radiator Cap .....	10242	16	2005-2001; OE Equivalent Fuel Cap .....	10834	
2011; OE Equivalent Fuel Cap .....	10834		2005-2001; Regular Locking Fuel Cap .....	10504	
2011; Regular Locking Fuel Cap .....	10504		2005-2001; Oil Filler Cap .....	10121	
2010; OE Type Radiator Cap .....	10242	16	<b>IS350</b>		
2010; Oil Filler Cap .....	10135		V-6 3.5 L		
2009-2007; OE Type Radiator Cap .....	10242	16	2012; OE Equivalent Fuel Cap .....	10834	
2009-2007; OE Equivalent Fuel Cap .....	10825		2012; Regular Locking Fuel Cap .....	10504	
2009-2007; Regular Locking Fuel Cap .....	10595		2011-2006; OE Type Radiator Cap .....	10242	16
2009-2007; Oil Filler Cap .....	10135		2011-2006; OE Equivalent Fuel Cap .....	10834	
<b>GS460</b>			2011-2006; Regular Locking Fuel Cap .....	10504	
V-8 4.6 L			2011-2006; Oil Filler Cap .....	10135	
2011; OE Type Radiator Cap .....	10254	19	<b>IS F</b>		
2011; OE Equivalent Fuel Cap .....	10834		V-8 5.0 L		
2011; Regular Locking Fuel Cap .....	10504		2012; OE Equivalent Fuel Cap .....	10834	
2010; OE Type Radiator Cap .....	10254	19	2012; Regular Locking Fuel Cap .....	10504	
2010; Oil Filler Cap .....	10135		2011-2008; OE Type Radiator Cap .....	10254	19
2009-2008; OE Type Radiator Cap .....	10254	19	2011-2008; OE Equivalent Fuel Cap .....	10834	
2009-2008; OE Equivalent Fuel Cap .....	10834		2011-2008; Regular Locking Fuel Cap .....	10504	
2009-2008; Regular Locking Fuel Cap .....	10504		<b>LS400</b>		
2009-2008; Oil Filler Cap .....	10135		V-8 4.0 L		
<b>GX460</b>			2000-1995; Lev-R-Vent Radiator Cap .....	✓10327	13
V-8 4.6 L			2000-1995; OE Type Radiator Cap .....	10227	13
2012; OE Equivalent Fuel Cap .....	10834		2000-1995; OE Equivalent Fuel Cap .....	10825	
2012; Regular Locking Fuel Cap .....	10504		2000-1995; Regular Locking Fuel Cap .....	10595	
2011; OE Type Radiator Cap .....	10242	16	2000-1995; Oil Filler Cap .....	10080	
2011; OE Equivalent Fuel Cap .....	10834		<b>LS430</b>		
2011; Regular Locking Fuel Cap .....	10504		V-8 4.3 L		
2010; OE Type Radiator Cap .....	10242	16	2006-2001; OE Type Radiator Cap .....	10242	16
2010; Oil Filler Cap .....	10135		2006-2001; OE Equivalent Fuel Cap .....	10834	
<b>GX470</b>			2006-2001; Regular Locking Fuel Cap .....	10504	
V-8 4.7 L			2006-2001; Oil Filler Cap .....	10080	
2009-2007; OE Type Radiator Cap .....	10242	16	<b>LS460</b>		
2009-2007; OE Equivalent Fuel Cap .....	10839		V-8 4.6 L		
2009-2007; Regular Locking Fuel Cap .....	10509		2012; OE Equivalent Fuel Cap .....	10834	
2009-2007; Oil Filler Cap .....	10080		2012; Regular Locking Fuel Cap .....	10504	
2006; OE Type Radiator Cap .....	10242	16	2011; OE Type Radiator Cap .....	10254	19
2006; OE Equivalent Fuel Cap .....	10839		2011; OE Equivalent Fuel Cap .....	10834	
2006; Regular Locking Fuel Cap .....	10509		2011; Regular Locking Fuel Cap .....	10504	
2005-2003; OE Type Radiator Cap .....	10242	16	2011; Oil Filler Cap .....	10135	
2005-2003; OE Equivalent Fuel Cap .....	10839		2010; OE Type Radiator Cap .....	10254	19
2005-2003; Regular Locking Fuel Cap .....	10509		2010; Oil Filler Cap .....	10135	
2005-2003; Oil Filler Cap .....	10080		2009-2007; OE Type Radiator Cap .....	10254	19
<b>HS250h</b>			2009-2007; OE Equivalent Fuel Cap .....	10834	
4-Cyl. 2.4 L Electric Assist			2009-2007; Regular Locking Fuel Cap .....	10504	
2011; OE Equivalent Fuel Cap .....	10834		2009-2007; Oil Filler Cap .....	10135	
2011; Regular Locking Fuel Cap .....	10504		<b>LS600h</b>		
2011; Oil Filler Cap .....	10135		V-8 5.0 L Electric Assist		
2010; OE Type Radiator Cap .....	10254	19	2012; OE Equivalent Fuel Cap .....	10825	
2010; Oil Filler Cap .....	10135		2012; Regular Locking Fuel Cap .....	10595	
<b>IS250</b>			2011; OE Type Radiator Cap .....	10254	19
V-6 2.5 L			2011; OE Equivalent Fuel Cap .....	10834	
2012; OE Equivalent Fuel Cap .....	10834		2011; Regular Locking Fuel Cap .....	10504	
2012; Regular Locking Fuel Cap .....	10504		2011; Oil Filler Cap .....	10135	
2011; OE Type Radiator Cap .....	10242	16	2010; OE Type Radiator Cap .....	10254	19
2011; OE Equivalent Fuel Cap .....	10834		2009-2008; OE Type Radiator Cap .....	10254	19
2011; Regular Locking Fuel Cap .....	10504		2009-2008; OE Equivalent Fuel Cap .....	10825	
2010-2007; OE Type Radiator Cap .....	10242	16	2009-2008; Regular Locking Fuel Cap .....	10595	
2010-2007; OE Equivalent Fuel Cap .....	10834		2009-2008; Oil Filler Cap .....	10135	
2010-2007; Regular Locking Fuel Cap .....	10504		<b>LX450</b>		
2010-2007; Oil Filler Cap .....	10135		6-Cyl. 4.5 L		
2006; OE Type Radiator Cap .....	10242	16	1997-1996; Lev-R-Vent Radiator Cap .....	✓10327	13
2006; OE Equivalent Fuel Cap .....	10834		1997-1996; OE Type Radiator Cap .....	10227	13
2006; Regular Locking Fuel Cap .....	10504		1997-1996; OE Equivalent Fuel Cap .....	10825	
2006; Oil Filler Cap .....	10121		1997-1996; Regular Locking Fuel Cap .....	10595	
<b>IS300</b>			1997-1996; Oil Filler Cap .....	10080	
6-Cyl. 3.0 L					
2005-2001; OE Type Radiator Cap .....	10242	16			

✓ Check Hood Clearance prior to installing this Cap.

## Caps for Passenger Cars and Light Trucks (1990 and Newer)

Application	Part Number	PSI	Application	Part Number	PSI
<b>Lexus - Continued</b>			<b>Lexus - Continued</b>		
<b>LX470</b>			<b>RX400h - Continued</b>		
<b>V-8 4.7 L</b>			<b>V-6 3.3 L Electric Assist - Continued</b>		
2007-2001; Lev-R-Vent Radiator Cap .....	✓10333	16	2008-2006; OE Equivalent Fuel Cap .....	10825	
2007-2001; OE Type Radiator Cap .....	10233	16	2008-2006; Regular Locking Fuel Cap .....	10595	
2007-2001; OE Equivalent Fuel Cap .....	10834		2008-2006; Oil Filler Cap .....	10121	
2007-2001; Regular Locking Fuel Cap .....	10504		<b>RX450h</b>		
2007-2001; Oil Filler Cap .....	10080		<b>V-6 3.5 L Electric Assist</b>		
2000-1998; Lev-R-Vent Radiator Cap .....	✓10333	16	2012; OE Equivalent Fuel Cap .....	10825	
2000-1998; OE Type Radiator Cap .....	10233	16	2012; Regular Locking Fuel Cap .....	10595	
2000-1998; OE Equivalent Fuel Cap .....	10825		2011; OE Type Radiator Cap .....	10242	16
2000-1998; Regular Locking Fuel Cap .....	10595		2011; OE Equivalent Fuel Cap .....	10834	
2000-1998; Oil Filler Cap .....	10080		2011; Regular Locking Fuel Cap .....	10504	
<b>LX570</b>			2010; OE Type Radiator Cap .....	10242	16
<b>V-8 5.7 L</b>			2010; OE Equivalent Fuel Cap .....	10825	
2011-2008; OE Type Radiator Cap .....	10242	16	2010; Regular Locking Fuel Cap .....	10595	
2011-2008; OE Equivalent Fuel Cap .....	10834		2010; Oil Filler Cap .....	10135	
2011-2008; Regular Locking Fuel Cap .....	10504		<b>SC300</b>		
2011-2008; Oil Filler Cap .....	10135		<b>6-Cyl. 3.0 L</b>		
<b>RX300</b>			2000-1997; OE Type Radiator Cap .....	10241	13
<b>V-6 3.0 L</b>			2000-1997; OE Equivalent Fuel Cap .....	10825	
2003; OE Type Radiator Cap .....	10242	16	2000-1997; Regular Locking Fuel Cap .....	10595	
2003; OE Equivalent Fuel Cap .....	10834		2000-1997; Oil Filler Cap .....	10121	
2003; Regular Locking Fuel Cap .....	10504		1996-1995; OE Type Radiator Cap .....	10241	13
2003; Oil Filler Cap .....	10121		1996-1995; OE Equivalent Fuel Cap .....	10825	
2002; Lev-R-Vent Radiator Cap .....	✓10333	16	1996-1995; Regular Locking Fuel Cap .....	10595	
2002; OE Type Radiator Cap .....	10233	16	1996-1995; Oil Filler Cap .....	10113	
2002; OE Equivalent Fuel Cap .....	10834		<b>SC400</b>		
2002; Regular Locking Fuel Cap .....	10504		<b>V-8 4.0 L</b>		
2002; Oil Filler Cap .....	10121		2000; OE Type Radiator Cap .....	10242	16
2001; OE Type Radiator Cap .....	10242	16	2000; OE Equivalent Fuel Cap .....	10825	
2001; OE Equivalent Fuel Cap .....	10834		2000; Regular Locking Fuel Cap .....	10595	
2001; Regular Locking Fuel Cap .....	10504		2000; Oil Filler Cap .....	10080	
2001; Oil Filler Cap .....	10121		1999-1995; Lev-R-Vent Radiator Cap .....	✓10327	13
2000-1999; OE Type Radiator Cap .....	10241	13	1999-1995; OE Type Radiator Cap .....	10227	13
2000-1999; OE Equivalent Fuel Cap .....	10825		1999-1995; OE Equivalent Fuel Cap .....	10825	
2000-1999; Regular Locking Fuel Cap .....	10595		1999-1995; Regular Locking Fuel Cap .....	10595	
2000-1999; Oil Filler Cap .....	10121		1999-1995; Oil Filler Cap .....	10080	
<b>RX330</b>			<b>SC430</b>		
<b>V-6 3.3 L</b>			<b>V-8 4.3 L</b>		
2006-2004; OE Type Radiator Cap .....	10241	13	2010; OE Type Radiator Cap .....	10242	16
2006-2004; OE Equivalent Fuel Cap .....	10839		2010; OE Equivalent Fuel Cap .....	10834	
2006-2004; Regular Locking Fuel Cap .....	10509		2010; Regular Locking Fuel Cap .....	10504	
2006-2004; Oil Filler Cap .....	10121		2010; Oil Filler Cap .....	10135	
<b>RX350</b>			2009-2002; OE Type Radiator Cap .....	10242	16
<b>V-6 3.5 L</b>			2009-2002; OE Equivalent Fuel Cap .....	10834	
2012; OE Equivalent Fuel Cap .....	10834		2009-2002; Regular Locking Fuel Cap .....	10504	
2012; Regular Locking Fuel Cap .....	10504		2009-2002; Oil Filler Cap .....	10080	
2011; OE Type Radiator Cap .....	10242	16	<b>Lincoln</b>		
2011; OE Equivalent Fuel Cap .....	10834		<b>Aviator</b>		
2011; Regular Locking Fuel Cap .....	10504		<b>V-8 4.6 L</b>		
2010; OE Type Radiator Cap .....	10242	16	2005; OE Type Radiator Cap .....	10238	16
2010; OE Equivalent Fuel Cap .....	10834		2005; OE Equivalent Fuel Cap; For Black Bottom O.E. Cap .....	10832	
2010; Regular Locking Fuel Cap .....	10504		2005; Regular Locking Fuel Cap; For Black Bottom O.E. Cap .....	10502	
2010; Oil Filler Cap .....	10135		2005; OE Equivalent Fuel Cap; For White Bottom O.E. Cap .....		
2009-2002; OE Type Radiator Cap .....	10242	16	W/Orange O-Ring Seal .....	10840	
2009-2002; OE Equivalent Fuel Cap .....	10834		2005; Regular Locking Fuel Cap; For White Bottom O.E. Cap .....		
2009-2002; Regular Locking Fuel Cap .....	10504		W/Orange O-Ring Seal .....	10510	
2009; OE Type Radiator Cap .....	10242	16	2005; Oil Filler Cap .....	10117	
2009; OE Equivalent Fuel Cap .....	10834		2004; OE Type Radiator Cap .....	10238	16
2009; Regular Locking Fuel Cap .....	10504		2004; OE Equivalent Fuel Cap; For Black Bottom O.E. Cap .....	10832	
2009; Oil Filler Cap .....	10080		2004; Regular Locking Fuel Cap; For Black Bottom O.E. Cap .....	10502	
2008; OE Type Radiator Cap .....	10242	16	2004; OE Equivalent Fuel Cap; For White Bottom O.E. Cap .....		
2008; OE Equivalent Fuel Cap .....	10834		W/Orange O-Ring Seal .....	10840	
2008; Regular Locking Fuel Cap .....	10504		2004; Regular Locking Fuel Cap; For White Bottom O.E. Cap .....		
2008; Oil Filler Cap .....	10135		W/Orange O-Ring Seal .....	10510	
2007; Lev-R-Vent Radiator Cap .....	✓10333	16	2004; Oil Filler Cap .....	10081	
2007; OE Type Radiator Cap .....	10233	16	2003; OE Type Radiator Cap .....	10238	16
2007; OE Equivalent Fuel Cap .....	10834		2003; OE Equivalent Fuel Cap .....	10832	
2007; Regular Locking Fuel Cap .....	10504		2003; Regular Locking Fuel Cap .....	10502	
2007; Oil Filler Cap .....	10135		<b>RX400h</b>		
<b>RX400h</b>			<b>V-6 3.3 L Electric Assist</b>		
<b>V-6 3.3 L Electric Assist</b>			2008-2006; OE Type Radiator Cap .....		
2008-2006; OE Type Radiator Cap .....			10241		
			13		

✓ Check Hood Clearance prior to installing this Cap.

## Caps for Passenger Cars and Light Trucks (1990 and Newer)

Application	Part Number	PSI	Application	Part Number	PSI
<b>Lincoln - Continued</b>			<b>Lincoln - Continued</b>		
<b>Aviator - Continued</b>			<b>Mark VIII - Continued</b>		
V-8 4.6 L - Continued			V-8 4.6 L - Continued		
2003; Oil Filler Cap .....	10081		1998-1997; Regular Locking Fuel Cap .....	10502	
<b>Blackwood</b>			1998-1997; Oil Filler Cap .....	10081	
V-8 5.4 L			1996-1995; OE Type Radiator Cap .....	10238	16
2002; OE Type Radiator Cap .....	10238	16	1996-1995; Pre-Vent Non-Locking Fuel Cap .....	10819	
2002; OE Equivalent Fuel Cap .....	10832		1996-1995; Pre-Vent Locking Fuel Cap .....	10501	
2002; Regular Locking Fuel Cap .....	10502		1996-1995; Oil Filler Cap .....	10081	
2002; Oil Filler Cap .....	10081		<b>MKS</b>		
<b>Continental</b>			V-6 3.5 L		
V-8 4.6 L			2011-2010; OE Type Radiator Cap .....	10238	16
2002-1998; OE Type Radiator Cap .....	10238	16	2011-2010; Oil Filler Cap .....	10117	
2002-1998; OE Equivalent Fuel Cap .....	10832		V-6 3.7 L		
2002-1998; Regular Locking Fuel Cap .....	10502		2011-2009; OE Type Radiator Cap .....	10238	16
2002-1998; Oil Filler Cap .....	10081		2011-2009; Oil Filler Cap .....	10117	
1997; OE Type Radiator Cap .....	10238	16	<b>MKT</b>		
1997; Pre-Vent Non-Locking Fuel Cap -On Fuel Cap; W/O Snap-On Fuel Cap .....	10819		V-6 3.5 L; V-6 3.7 L		
1997; Pre-Vent Locking Fuel Cap -On Fuel Cap; W/O Snap-On Fuel Cap .....	10501		2011-2010; OE Type Radiator Cap .....	10238	16
1997; OE Equivalent Fuel Cap -On Fuel Cap; W/Snap-On Fuel Cap .....	10832		2011-2010; Oil Filler Cap .....	10117	
1997; Regular Locking Fuel Cap -On Fuel Cap; W/Snap-On Fuel Cap .....	10502		<b>MKX</b>		
1997; Oil Filler Cap .....	10081		V-6 3.5 L		
1996-1995; OE Type Radiator Cap .....	10238	16	2010-2007; OE Type Radiator Cap .....	10238	16
1996-1995; Pre-Vent Non-Locking Fuel Cap .....	10819		2010-2007; OE Equivalent Fuel Cap .....	10840	
1996-1995; Pre-Vent Locking Fuel Cap .....	10501		2010-2007; Regular Locking Fuel Cap .....	10510	
1996-1995; Oil Filler Cap .....	10081		2010-2007; Oil Filler Cap .....	10117	
<b>LS</b>			V-6 3.7 L		
V-6 3.0 L			2011; OE Type Radiator Cap .....	10238	16
2005-2004; OE Type Radiator Cap .....	10238	16	2011; Oil Filler Cap .....	10117	
2005-2004; OE Equivalent Fuel Cap .....	10832		<b>MKZ</b>		
2005-2004; Regular Locking Fuel Cap .....	10502		V-6 3.5 L		
2005-2004; Oil Filler Cap .....	10081		2011-2010; OE Type Radiator Cap .....	10238	16
2003-2001; OE Type Radiator Cap .....	10238	16	2011-2010; Oil Filler Cap .....	10117	
2003-2001; OE Equivalent Fuel Cap .....	10832		2009; OE Type Radiator Cap .....	10238	16
2003-2001; Regular Locking Fuel Cap .....	10502		2009; OE Equivalent Fuel Cap .....	10840	
2003-2001; Oil Filler Cap .....	10117		2009; Regular Locking Fuel Cap .....	10510	
2000; OE Type Radiator Cap .....	10238	16	2009; Oil Filler Cap .....	10117	
2000; OE Equivalent Fuel Cap .....	10832		2008-2007; OE Type Radiator Cap .....	10238	16
2000; Regular Locking Fuel Cap .....	10502		2008-2007; OE Equivalent Fuel Cap .....	10840	
2000; Oil Filler Cap .....	10081		2008-2007; Flex Fuel Regular Fuel Cap .....	10840Y	
V-8 3.9 L			2008-2007; Regular Locking Fuel Cap .....	10510	
2006; OE Type Radiator Cap .....	10238	16	2008-2007; Flex Fuel Regular Locking Fuel Cap .....	10510Y	
2006; OE Equivalent Fuel Cap .....	10832		2008-2007; Oil Filler Cap .....	10117	
2006; Regular Locking Fuel Cap .....	10502		<b>Navigator</b>		
2006; Oil Filler Cap .....	10101		V-8 5.4 L		
2005-2003; OE Type Radiator Cap .....	10238	16	2011-2009; Lev-R-Vent Radiator Cap .....	10333	16
2005-2003; OE Equivalent Fuel Cap .....	10832		2011-2009; OE Type Radiator Cap .....	10233	16
2005-2003; Regular Locking Fuel Cap .....	10502		2011-2009; Oil Filler Cap .....	10117	
2005-2003; Oil Filler Cap .....	10081		2008-2005; OE Type Radiator Cap .....	10238	16
2002; OE Type Radiator Cap .....	10238	16	2008-2005; OE Equivalent Fuel Cap .....	10840	
2002; OE Equivalent Fuel Cap .....	10832		2008-2005; Regular Locking Fuel Cap .....	10510	
2002; Regular Locking Fuel Cap .....	10502		2008-2005; Oil Filler Cap .....	10117	
2002; Oil Filler Cap .....	10101		2004-1998; OE Type Radiator Cap .....	10238	16
2001-2000; OE Type Radiator Cap .....	10238	16	2004-1998; OE Equivalent Fuel Cap .....	10832	
2001-2000; OE Equivalent Fuel Cap .....	10832		2004-1998; Regular Locking Fuel Cap .....	10502	
2001-2000; Regular Locking Fuel Cap .....	10502		2004-1998; Oil Filler Cap .....	10081	
2001-2000; Oil Filler Cap .....	10081		<b>Town Car</b>		
<b>Mark LT</b>			V-8 4.6 L		
V-8 5.4 L			2011-2010; OE Type Radiator Cap .....	10238	16
2008-2006; OE Type Radiator Cap .....	10238	16	2011-2010; OE Equivalent Fuel Cap .....	10840	
2008-2006; OE Equivalent Fuel Cap .....	10840		2011-2010; Flex Fuel Regular Fuel Cap .....	10840Y	
2008-2006; Regular Locking Fuel Cap .....	10510		2011-2010; Regular Locking Fuel Cap .....	10510	
2008-2006; Oil Filler Cap .....	10117		2011-2010; Flex Fuel Regular Locking Fuel Cap .....	10510Y	
<b>Mark VIII</b>			2011-2010; Oil Filler Cap .....	10117	
V-8 4.6 L			2009-2007; OE Type Radiator Cap .....	10238	16
1998-1997; OE Type Radiator Cap .....	10238	16	2009-2007; OE Equivalent Fuel Cap .....	10840	
1998-1997; OE Equivalent Fuel Cap .....	10832		2009-2007; Regular Locking Fuel Cap .....	10510	
			2009-2007; Flex Fuel Regular Fuel Cap .....	10840Y	
			2009-2007; Flex Fuel Regular Locking Fuel Cap .....	10510Y	

## Caps for Passenger Cars and Light Trucks (1990 and Newer)

Application	Part Number	PSI	Application	Part Number	PSI
<b>Lincoln - Continued</b>			<b>Mazda - Continued</b>		
<b>Town Car - Continued</b>			<b>3 - Continued</b>		
<b>V-8 4.6 L - Continued</b>			<b>4-Cyl. 2.5 L - Continued</b>		
2009-2007: Oil Filler Cap .....	10117		2010: OE Equivalent Fuel Cap .....	10840	
2006: OE Type Radiator Cap .....	10238	16	2010: Regular Locking Fuel Cap .....	10510	
2006: OE Equivalent Fuel Cap .....	10840		<b>5</b>		
2006: Regular Locking Fuel Cap .....	10510		<b>4-Cyl. 2.3 L</b>		
2006: Oil Filler Cap .....	10117		2010: OE Type Radiator Cap .....	10242	16
2005: OE Type Radiator Cap .....	10238	16	2010: OE Equivalent Fuel Cap .....	10851	
2005: OE Equivalent Fuel Cap .....	10840		2010: Regular Locking Fuel Cap .....	10521	
2005: Regular Locking Fuel Cap .....	10510		2009-2006: OE Type Radiator Cap .....	10242	16
2005: Oil Filler Cap .....	10101		2009-2006: OE Equivalent Fuel Cap .....	10851	
2004-2003: OE Type Radiator Cap .....	10238	16	2009-2006: Regular Locking Fuel Cap .....	10521	
2004-2003: OE Equivalent Fuel Cap .....	10832		2009-2006: Oil Filler Cap .....	10144	
2004-2003: Regular Locking Fuel Cap .....	10502		<b>6</b>		
2004-2003: Oil Filler Cap .....	10117		<b>4-Cyl. 2.3 L</b>		
2002-1996: OE Type Radiator Cap .....	10238	16	2008: OE Type Radiator Cap .....	10267	20
2002-1996: OE Equivalent Fuel Cap .....	10832		2008: OE Equivalent Fuel Cap .....	10838	
2002-1996: Regular Locking Fuel Cap .....	10502		2008: Regular Locking Fuel Cap .....	10508	
2002-1996: Oil Filler Cap .....	10081		2008: Oil Filler Cap .....	10144	
1995: OE Type Radiator Cap .....	10238	16	2007: OE Type Radiator Cap .....	10267	20
1995: Pre-Vent Non-Locking Fuel Cap .....	10819		2007: OE Equivalent Fuel Cap .....	10838	
1995: Pre-Vent Locking Fuel Cap .....	10501		2007: Regular Locking Fuel Cap .....	10508	
1995: Oil Filler Cap .....	10081		2007: Oil Filler Cap; W/O Turbo .....	10144	
<b>Zephyr</b>			2007: Oil Filler Cap; W/Turbo .....	10101	
<b>V-6 3.0 L</b>			2006-2004: OE Type Radiator Cap .....	10267	20
2006: OE Type Radiator Cap .....	10238	16	2006-2004: OE Equivalent Fuel Cap .....	10838	
2006: OE Equivalent Fuel Cap .....	10840		2006-2004: Regular Locking Fuel Cap .....	10508	
2006: Regular Locking Fuel Cap .....	10510		2006-2004: Oil Filler Cap .....	10144	
2006: Oil Filler Cap .....	10117		2003: OE Type Radiator Cap .....	10267	20
<b>Mazda</b>			2003: OE Equivalent Fuel Cap .....	10838	
<b>2</b>			2003: Regular Locking Fuel Cap .....	10508	
<b>4-Cyl. 1.5 L</b>			2003: Oil Filler Cap .....	10101	
2011: OE Type Radiator Cap .....	10242	16	<b>4-Cyl. 2.5 L</b>		
2011: OE Equivalent Fuel Cap .....	10834		2011: OE Equivalent Fuel Cap .....	10840	
2011: Regular Locking Fuel Cap .....	10504		2011: Regular Locking Fuel Cap .....	10510	
2011: Oil Filler Cap .....	10082		2010: OE Type Radiator Cap .....	10248	15
<b>3</b>			2010: OE Equivalent Fuel Cap .....	10840	
<b>4-Cyl. 2.0 L</b>			2010: Regular Locking Fuel Cap .....	10510	
2011: OE Equivalent Fuel Cap .....	10840		2009: OE Type Radiator Cap .....	10248	15
2011: Regular Locking Fuel Cap .....	10510		2009: OE Equivalent Fuel Cap .....	10510	
2010: OE Type Radiator Cap .....	10262	21	2009: Regular Locking Fuel Cap .....	10521	
2010: OE Equivalent Fuel Cap .....	10840		2009: Oil Filler Cap .....	10144	
2010: Regular Locking Fuel Cap .....	10510		2004-2003: OE Type Radiator Cap .....	10248	15
2009-2004: OE Type Radiator Cap .....	10262	21	2004-2003: OE Equivalent Fuel Cap .....	10838	
2009-2004: OE Equivalent Fuel Cap .....	10851		2004-2003: Regular Locking Fuel Cap .....	10508	
2009-2004: Regular Locking Fuel Cap .....	10521		2004-2003: Oil Filler Cap .....	10117	
2009-2004: Oil Filler Cap .....	10144		<b>V-6 3.7 L</b>		
<b>4-Cyl. 2.3 L</b>			2011: OE Equivalent Fuel Cap .....	10840	
2011: OE Equivalent Fuel Cap .....	10840		2011: Regular Locking Fuel Cap .....	10510	
2011: Regular Locking Fuel Cap .....	10510	21	2010-2009: OE Type Radiator Cap .....	10248	15
2010: OE Type Radiator Cap .....	10262	21	2010-2009: OE Equivalent Fuel Cap .....	10840	
2010: OE Equivalent Fuel Cap .....	10840		2010-2009: Regular Locking Fuel Cap .....	10510	
2010: Regular Locking Fuel Cap .....	10510		2010-2009: Oil Filler Cap .....	10117	
2009: OE Type Radiator Cap .....	10262	21	<b>626</b>		
2009: OE Equivalent Fuel Cap .....	10851		<b>4-Cyl. 2.0 L</b>		
2009: Regular Locking Fuel Cap .....	10521		2002-1998: Lev-R-Vent Radiator Cap .....	✓10333	16
2009: Oil Filler Cap .....	10144		2002-1998: OE Type Radiator Cap .....	10233	16
2008: OE Type Radiator Cap .....	10262	21	2002-1998: OE Equivalent Fuel Cap .....	10834	
2008: OE Equivalent Fuel Cap .....	10851		2002-1998: Regular Locking Fuel Cap .....	10504	
2008: Regular Locking Fuel Cap .....	10521		2002-1998: Oil Filler Cap .....	10082	
2008: Oil Filler Cap; W/Turbo .....	10101		1997-1995: Lev-R-Vent Radiator Cap .....	✓10333	16
2008: Oil Filler Cap; W/O Turbo .....	10144		1997-1995: OE Type Radiator Cap .....	10233	16
2007-2004: OE Type Radiator Cap .....	10262	21	1997-1995: OE Equivalent Fuel Cap .....	10817	
2007-2004: OE Equivalent Fuel Cap .....	10851		1997-1995: Pre-Vent Non-Locking Fuel Cap .....	10819	
2007-2004: Regular Locking Fuel Cap .....	10521		1997-1995: Regular Locking Fuel Cap .....	10591	
2007-2004: Oil Filler Cap .....	10144		1997-1995: Pre-Vent Locking Fuel Cap .....	10501	
<b>4-Cyl. 2.5 L</b>					
2011: OE Equivalent Fuel Cap .....	10840				
2011: Regular Locking Fuel Cap .....	10510				
2010: OE Type Radiator Cap .....	10262	21			

✓ Check Hood Clearance prior to installing this Cap.

## Caps for Passenger Cars and Light Trucks (1990 and Newer)

Application	Part Number	PSI	Application	Part Number	PSI
<b>Mazda - Continued</b>			<b>Mazda - Continued</b>		
<b>626 - Continued</b>			<b>B3000 Pickup - Continued</b>		
<b>4-Cyl. 2.0 L - Continued</b>			<b>V-6 3.0 L - Continued</b>		
1997-1995; Oil Filler Cap .....	10082		2007; Regular Locking Fuel Cap .....	10510	
<b>V-6 2.5 L</b>			2007; Oil Filler Cap .....	10117	
2002-1998; Lev-R-Vent Radiator Cap .....	✓10333	16	2006-2004; Lev-R-Vent Radiator Cap .....	✓10333	16
2002-1998; OE Type Radiator Cap .....	10233	16	2006-2004; OE Type Radiator Cap .....	10233	16
2002-1998; OE Equivalent Fuel Cap .....	10834		2006-2004; OE Equivalent Fuel Cap .....	10840	
2002-1998; Regular Locking Fuel Cap .....	10504		2006-2004; Regular Locking Fuel Cap .....	10510	
2002-1998; Oil Filler Cap .....	10082		2006-2004; Oil Filler Cap .....	10117	
1997-1995; Lev-R-Vent Radiator Cap .....	✓10327	13	2003; Lev-R-Vent Radiator Cap .....	✓10333	16
1997-1995; OE Type Radiator Cap .....	10227	13	2003; OE Type Radiator Cap .....	10233	16
1997-1995; OE Equivalent Fuel Cap .....	10817		2003; OE Equivalent Fuel Cap .....	10832	
1997-1995; Pre-Vent Non-Locking Fuel Cap .....	10819		2003; Regular Locking Fuel Cap .....	10502	
1997-1995; Regular Locking Fuel Cap .....	10591		2003; Oil Filler Cap .....	10117	
1997-1995; Pre-Vent Locking Fuel Cap .....	10501		2002-2001; Lev-R-Vent Radiator Cap .....	✓10333	16
1997-1995; Oil Filler Cap .....	10082		2002-2001; OE Type Radiator Cap .....	10233	16
<b>929</b>			2002-2001; OE Equivalent Fuel Cap .....	10832	
<b>V-6 3.0 L</b>			2002-2001; Flex Fuel Regular Fuel Cap .....	10832Y	
1995; Lev-R-Vent Radiator Cap .....	✓10327	13	2002-2001; Regular Locking Fuel Cap .....	10502	
1995; OE Type Radiator Cap .....	10227	13	2002-2001; Flex Fuel Regular Locking Fuel Cap .....	10502Y	
1995; OE Equivalent Fuel Cap .....	10817		2002-2001; Oil Filler Cap .....	10117	
1995; Pre-Vent Non-Locking Fuel Cap .....	10819		2000; Lev-R-Vent Radiator Cap .....	✓10333	16
1995; Regular Locking Fuel Cap .....	10591		2000; OE Type Radiator Cap .....	10233	16
1995; Pre-Vent Locking Fuel Cap .....	10501		2000; OE Equivalent Fuel Cap .....	10832	
1995; Oil Filler Cap .....	10082		2000; Flex Fuel Regular Fuel Cap .....	10832Y	
<b>B2300 Pickup</b>			2000; Regular Locking Fuel Cap .....	10502	
<b>4-Cyl. 2.3 L</b>			2000; Flex Fuel Regular Locking Fuel Cap .....	10502Y	
2009-2006; OE Type Radiator Cap .....	10238	16	2000; Oil Filler Cap .....	10081	
2009-2006; OE Equivalent Fuel Cap .....	10840		1999; Lev-R-Vent Radiator Cap .....	✓10333	16
2009-2006; Regular Locking Fuel Cap .....	10510		1999; OE Type Radiator Cap .....	10233	16
2009-2006; Oil Filler Cap .....	10144		1999; OE Equivalent Fuel Cap .....	10832	
2005; Lev-R-Vent Radiator Cap .....	10333	16	1999; Regular Locking Fuel Cap .....	10502	
2005; OE Type Radiator Cap .....	10233	16	1999; Oil Filler Cap .....	10081	
2005; OE Equivalent Fuel Cap .....	10840		1998; Lev-R-Vent Radiator Cap .....	✓10333	16
2005; Regular Locking Fuel Cap .....	10510		1998; OE Type Radiator Cap .....	10233	16
2004; OE Type Radiator Cap .....	10238	16	1998; OE Equivalent Fuel Cap .....	10832	
2004; OE Equivalent Fuel Cap .....	10840		1998; Regular Locking Fuel Cap .....	10502	
2004; Regular Locking Fuel Cap .....	10510		1998; Oil Filler Cap .....	10081	
2004; Oil Filler Cap .....	10144		1996-1995; Lev-R-Vent Radiator Cap .....	✓10327	13
2003-2001; OE Type Radiator Cap .....	10238	16	1996-1995; OE Type Radiator Cap .....	10227	13
2003-2001; OE Equivalent Fuel Cap .....	10832		1996-1995; Pre-Vent Non-Locking Fuel Cap .....	10819	
2003-2001; Regular Locking Fuel Cap .....	10502		1996-1995; Pre-Vent Locking Fuel Cap .....	10501	
2003-2001; Oil Filler Cap .....	10081		1996-1995; Oil Filler Cap .....	10081	
1997-1995; Lev-R-Vent Radiator Cap .....	10330	16	<b>V-6 3.0 L (Canada)</b>		
1997-1995; OE Type Radiator Cap .....	10230	16	2008; Lev-R-Vent Radiator Cap .....	10333	16
1997-1995; Pre-Vent Non-Locking Fuel Cap .....	10819		2008; OE Type Radiator Cap .....	10233	16
1997-1995; Pre-Vent Locking Fuel Cap .....	10501		2008; OE Equivalent Fuel Cap .....	10840	
1997-1995; Oil Filler Cap .....	10081		2008; Regular Locking Fuel Cap .....	10510	
<b>B2500 Pickup</b>			2008; Oil Filler Cap .....	10117	
<b>4-Cyl. 2.5 L</b>			<b>B4000 Pickup</b>		
2001-1999; Lev-R-Vent Radiator Cap .....	✓10333	16	<b>V-6 4.0 L</b>		
2001-1999; OE Type Radiator Cap .....	10233	16	2009-2007; Lev-R-Vent Radiator Cap .....	10333	16
2001-1999; OE Equivalent Fuel Cap .....	10832		2009-2007; OE Type Radiator Cap .....	10233	16
2001-1999; Regular Locking Fuel Cap .....	10502		2009-2007; OE Equivalent Fuel Cap .....	10840	
2001-1999; Oil Filler Cap .....	10081		2009-2007; Regular Locking Fuel Cap .....	10510	
1998; Lev-R-Vent Radiator Cap .....	✓10333	16	2009-2007; Oil Filler Cap .....	10117	
1998; OE Type Radiator Cap .....	10233	16	2006-2005; Lev-R-Vent Radiator Cap .....	✓10333	16
1998; OE Equivalent Fuel Cap -On Fuel Cap; W/Snap-On Fuel Cap .....	10832		2006-2005; OE Type Radiator Cap .....	10233	16
1998; Regular Locking Fuel Cap -On Fuel Cap; W/Snap-On Fuel Cap .....	10502		2006-2005; OE Equivalent Fuel Cap .....	10840	
1998; Pre-Vent Non-Locking Fuel Cap -On Fuel Cap; W/O Snap-On Fuel Cap .....	10819		2006-2005; Regular Locking Fuel Cap .....	10510	
1998; Pre-Vent Locking Fuel Cap -On Fuel Cap; W/O Snap-On Fuel Cap .....	10501		2006-2005; Oil Filler Cap .....	10117	
1998; Oil Filler Cap .....	10081		2004; Lev-R-Vent Radiator Cap .....	✓10333	16
<b>B3000 Pickup</b>			2004; OE Type Radiator Cap .....	10233	16
<b>V-6 3.0 L</b>			2004; OE Equivalent Fuel Cap .....	10840	
2007; Lev-R-Vent Radiator Cap .....	10333	16	2004; Regular Locking Fuel Cap .....	10510	
2007; OE Type Radiator Cap .....	10233	16	2003-2001; Lev-R-Vent Radiator Cap .....	✓10333	16
2007; OE Equivalent Fuel Cap .....	10840		2003-2001; OE Type Radiator Cap .....	10233	16
			2003-2001; OE Equivalent Fuel Cap .....	10832	

✓ Check Hood Clearance prior to installing this Cap.



## Caps for Passenger Cars and Light Trucks (1990 and Newer)

Application	Part Number	PSI	Application	Part Number	PSI
<b>Mazda - Continued</b>			<b>Mazda - Continued</b>		
<b>B4000 Pickup - Continued</b>			<b>Millenia</b>		
<b>V-6 4.0 L - Continued</b>			<b>V-6 2.3 L; V-6 2.5 L</b>		
2003-2001; Regular Locking Fuel Cap .....	10502		2002-2000; Lev-R-Vent Radiator Cap .....	✓10333	16
2003-2001; Oil Filler Cap .....	10117		2002-2000; OE Type Radiator Cap .....	10233	16
2000-1999; Lev-R-Vent Radiator Cap .....	✓10333	16	2002-2000; OE Equivalent Fuel Cap .....	10834	
2000-1999; OE Type Radiator Cap .....	10233	16	2002-2000; Regular Locking Fuel Cap .....	10504	
2000-1999; OE Equivalent Fuel Cap .....	10832		2002-2000; Oil Filler Cap .....	10082	
2000-1999; Regular Locking Fuel Cap .....	10502		1999-1995; Lev-R-Vent Radiator Cap .....	✓10333	16
2000-1999; Oil Filler Cap .....	10081		1999-1995; OE Type Radiator Cap .....	10233	16
1998; Lev-R-Vent Radiator Cap .....	✓10333	16	1999-1995; OE Equivalent Fuel Cap .....	10817	
1998; OE Type Radiator Cap .....	10233	16	1999-1995; Pre-Vent Non-Locking Fuel Cap .....	10819	
1998; OE Equivalent Fuel Cap -On Fuel Cap; W/Snap-On Fuel Cap .....	10832		1999-1995; Regular Locking Fuel Cap .....	10591	
1998; Regular Locking Fuel Cap -On Fuel Cap; W/Snap-On Fuel Cap .....	10502		1999-1995; Pre-Vent Locking Fuel Cap .....	10501	
1998; Pre-Vent Non-Locking Fuel Cap -On Fuel Cap; W/O Snap-On Fuel Cap .....	10819		1999-1995; Oil Filler Cap .....	10082	
1998; Pre-Vent Locking Fuel Cap -On Fuel Cap; W/O Snap-On Fuel Cap .....	10501		<b>MPV</b>		
1998; Oil Filler Cap .....	10081		<b>V-6 2.5 L</b>		
1997-1995; Lev-R-Vent Radiator Cap .....	✓10327	13	2001-2000; Lev-R-Vent Radiator Cap .....	✓10333	16
1997-1995; OE Type Radiator Cap .....	10227	13	2001-2000; OE Type Radiator Cap .....	10233	16
1997-1995; Pre-Vent Non-Locking Fuel Cap .....	10819		2001-2000; OE Equivalent Fuel Cap .....	10834	
1997-1995; Pre-Vent Locking Fuel Cap .....	10501		2001-2000; Regular Locking Fuel Cap .....	10504	
1997-1995; Oil Filler Cap .....	10081		2001-2000; Oil Filler Cap .....	10081	
<b>V-6 4.0 L (Canada)</b>			<b>V-6 3.0 L</b>		
2010; Lev-R-Vent Radiator Cap .....	10333	16	2006; Lev-R-Vent Radiator Cap .....	✓10333	16
2010; OE Type Radiator Cap .....	10233	16	2006; OE Type Radiator Cap .....	10233	16
2010; OE Equivalent Fuel Cap .....	10840		2006; OE Equivalent Fuel Cap .....	10838	
2010; Regular Locking Fuel Cap .....	10510		2006; Regular Locking Fuel Cap .....	10508	
2010; Oil Filler Cap .....	10117		2006; Oil Filler Cap .....	10117	
<b>CX-7</b>			2005-2004; Lev-R-Vent Radiator Cap .....	✓10333	16
<b>4-Cyl. 2.3 L</b>			2005-2004; OE Type Radiator Cap .....	10233	16
2011; OE Equivalent Fuel Cap .....	10840		2005-2004; OE Equivalent Fuel Cap .....	10834	
2011; Regular Locking Fuel Cap .....	10510		2005-2004; Regular Locking Fuel Cap .....	10504	
2010; OE Type Radiator Cap .....	10267	20	2005-2004; Oil Filler Cap .....	10117	
2010; OE Equivalent Fuel Cap .....	10840		2003; Lev-R-Vent Radiator Cap .....	10333	16
2010; Regular Locking Fuel Cap .....	10510		2003; OE Type Radiator Cap .....	10233	16
2009; OE Type Radiator Cap .....	10267	20	2003; OE Equivalent Fuel Cap .....	10834	
2009; OE Equivalent Fuel Cap .....	10838		2003; Regular Locking Fuel Cap .....	10504	
2009; Regular Locking Fuel Cap .....	10508		2003; Oil Filler Cap .....	10117	
2008-2007; OE Type Radiator Cap .....	10267	20	2002; Lev-R-Vent Radiator Cap .....	✓10333	16
2008-2007; OE Equivalent Fuel Cap .....	10838		2002; OE Type Radiator Cap .....	10233	16
2008-2007; Regular Locking Fuel Cap .....	10508		2002; OE Equivalent Fuel Cap .....	10834	
2008-2007; Oil Filler Cap .....	10101		2002; Regular Locking Fuel Cap .....	10504	
<b>4-Cyl. 2.5 L</b>			2002; Oil Filler Cap .....	10117	
2011-2010; OE Equivalent Fuel Cap .....	10840		1998-1996; Lev-R-Vent Radiator Cap .....	✓10327	13
2011-2010; Regular Locking Fuel Cap .....	10510		1998-1996; OE Type Radiator Cap .....	10227	13
<b>CX-9</b>			1998-1996; OE Equivalent Fuel Cap .....	10817	
<b>V-6 3.5 L</b>			1998-1996; Pre-Vent Non-Locking Fuel Cap .....	10819	
2007; Lev-R-Vent Radiator Cap .....	10333	16	1998-1996; Regular Locking Fuel Cap .....	10591	
2007; OE Type Radiator Cap .....	10233	16	1998-1996; Pre-Vent Locking Fuel Cap .....	10501	
2007; OE Equivalent Fuel Cap .....	10840		1998-1996; Oil Filler Cap .....	10082	
<b>V-6 3.7 L</b>			1995; Lev-R-Vent Radiator Cap .....	✓10327	13
2011; OE Equivalent Fuel Cap .....	10840		1995; OE Type Radiator Cap .....	10227	13
2011; Regular Locking Fuel Cap .....	10510		1995; OE Equivalent Fuel Cap .....	10826	
2010; Lev-R-Vent Radiator Cap .....	10333	16	1995; Regular Locking Fuel Cap .....	10596	
2010; OE Type Radiator Cap .....	10233	16	1995; Oil Filler Cap .....	10082	
2010; OE Equivalent Fuel Cap .....	10840		<b>MX-3</b>		
2010; Regular Locking Fuel Cap .....	10510		<b>4-Cyl. 1.6 L; V-6 1.8 L (Canada)</b>		
2010; Oil Filler Cap .....	10117		1995; Lev-R-Vent Radiator Cap .....	✓10327	13
2009; Lev-R-Vent Radiator Cap .....	10333	16	1995; OE Type Radiator Cap .....	10227	13
2009; OE Type Radiator Cap .....	10233	16	1995; OE Equivalent Fuel Cap .....	10826	
2009; OE Equivalent Fuel Cap .....	10838		1995; Regular Locking Fuel Cap .....	10596	
2009; Regular Locking Fuel Cap .....	10508		1995; Oil Filler Cap .....	10082	
2009; Oil Filler Cap .....	10117		<b>MX-5 Miata</b>		
2008; Lev-R-Vent Radiator Cap .....	10333	16	<b>4-Cyl. 1.8 L</b>		
2008; OE Type Radiator Cap .....	10233	16	2005-2004; Lev-R-Vent Radiator Cap .....	✓10333	16
2008; OE Equivalent Fuel Cap .....	10840		2005-2004; OE Type Radiator Cap .....	10233	16
2008; Oil Filler Cap .....	10117		2005-2004; Oil Filler Cap .....	10082	
			2003-1999; Lev-R-Vent Radiator Cap .....	✓10333	16
			2003-1999; OE Type Radiator Cap .....	10233	16
			2003-1999; OE Equivalent Fuel Cap .....	10834	
			2003-1999; Regular Locking Fuel Cap .....	10504	
			2003-1999; Oil Filler Cap .....	10082	
			1997; Lev-R-Vent Radiator Cap .....	✓10327	13

✓ Check Hood Clearance prior to installing this Cap.

## Caps for Passenger Cars and Light Trucks (1990 and Newer)

Application	Part Number	PSI	Application	Part Number	PSI
<b>Mazda - Continued</b>			<b>Mazda - Continued</b>		
<b>MX-5 Miata - Continued</b>			<b>Protege - Continued</b>		
<b>4-Cyl. 1.8 L - Continued</b>			<b>4-Cyl. 1.8 L - Continued</b>		
1997: OE Type Radiator Cap .....	10227	13	2000: OE Type Radiator Cap; W/Auto. Trans. ....	10233	16
1997: OE Equivalent Fuel Cap .....	10834		2000: OE Type Radiator Cap; W/Man. Trans. ....	10242	16
1997: Regular Locking Fuel Cap .....	10504		2000: OE Equivalent Fuel Cap .....	10834	
1997: Oil Filler Cap .....	10082		2000: Regular Locking Fuel Cap .....	10504	
1996-1995: Lev-R-Vent Radiator Cap .....	✓10327	13	2000: Oil Filler Cap .....	10082	
1996-1995: OE Type Radiator Cap .....	10227	13	1999: Lev-R-Vent Radiator Cap; W/Auto. Trans. ....	✓10327	13
1996-1995: Oil Filler Cap .....	10082		1999: OE Type Radiator Cap; W/Auto. Trans. ....	10227	13
<b>4-Cyl. 2.0 L</b>			<b>4-Cyl. 2.0 L</b>		
2011: OE Equivalent Fuel Cap .....	10838		1999: OE Type Radiator Cap; W/Man. Trans. ....	10241	13
2011: Regular Locking Fuel Cap .....	10508		1999: OE Equivalent Fuel Cap .....	10834	
2010: Lev-R-Vent Radiator Cap .....	10333	16	1999: Regular Locking Fuel Cap .....	10504	
2010: OE Type Radiator Cap .....	10233	16	1999: Oil Filler Cap .....	10082	
2010: OE Equivalent Fuel Cap .....	10838		1998-1995: Lev-R-Vent Radiator Cap; W/Auto. Trans. ....	✓10327	13
2010: Regular Locking Fuel Cap .....	10508		1998-1995: OE Type Radiator Cap; W/Auto. Trans. ....	10227	13
2009: Lev-R-Vent Radiator Cap .....	10333	16	1998-1995: OE Type Radiator Cap; W/Man. Trans. ....	10241	13
2009: OE Type Radiator Cap .....	10233	16	1998-1995: OE Equivalent Fuel Cap .....	10817	
2009: OE Equivalent Fuel Cap .....	10838		1998-1995: Pre-Vent Non-Locking Fuel Cap .....	10819	
2009: Oil Filler Cap .....	10144		1998-1995: Regular Locking Fuel Cap .....	10591	
2008-2007: Lev-R-Vent Radiator Cap .....	10333	16	1998-1995: Pre-Vent Locking Fuel Cap .....	10501	
2008-2007: OE Type Radiator Cap .....	10233	16	1998-1995: Oil Filler Cap .....	10082	
2008-2007: OE Equivalent Fuel Cap .....	10838		<b>4-Cyl. 2.0 L</b>		
2008-2007: Regular Locking Fuel Cap .....	10508		2003-2001: Lev-R-Vent Radiator Cap; W/Auto. Trans. ....	✓10333	16
2008-2007: Oil Filler Cap .....	10144		2003-2001: OE Type Radiator Cap; W/Auto. Trans. ....	10233	16
2006: Lev-R-Vent Radiator Cap .....	✓10333	16	2003-2001: OE Type Radiator Cap; W/Man. Trans. ....	10242	16
2006: OE Type Radiator Cap .....	10233	16	2003-2001: OE Equivalent Fuel Cap .....	10834	
2006: OE Equivalent Fuel Cap .....	10838		2003-2001: Regular Locking Fuel Cap .....	10504	
2006: Regular Locking Fuel Cap .....	10508		2003-2001: Oil Filler Cap .....	10082	
2006: Oil Filler Cap .....	10144		<b>RX-7</b>		
<b>MX-6</b>			<b>2-Rotor 1.3 L</b>		
<b>4-Cyl. 2.0 L</b>			1995: Lev-R-Vent Radiator Cap .....		
1997-1995: Lev-R-Vent Radiator Cap .....	✓10333	16	1995: OE Type Radiator Cap .....	10227	13
1997-1995: OE Type Radiator Cap .....	10233	16	1995: OE Equivalent Fuel Cap .....	10817	
1997-1995: OE Equivalent Fuel Cap .....	10817		1995: Pre-Vent Non-Locking Fuel Cap .....	10819	
1997-1995: Pre-Vent Non-Locking Fuel Cap .....	10819		1995: Regular Locking Fuel Cap .....	10591	
1997-1995: Regular Locking Fuel Cap .....	10591		1995: Pre-Vent Locking Fuel Cap .....	10501	
1997-1995: Pre-Vent Locking Fuel Cap .....	10501		1995: Oil Filler Cap .....	10082	
1997-1995: Oil Filler Cap .....	10082		<b>RX-8</b>		
<b>V-6 2.5 L</b>			<b>2-Rotor 1.3 L</b>		
1997-1995: Lev-R-Vent Radiator Cap .....	✓10327	13	2011: OE Equivalent Fuel Cap .....		
1997-1995: OE Type Radiator Cap .....	10227	13	2011: Regular Locking Fuel Cap .....		
1997-1995: OE Equivalent Fuel Cap .....	10817		2010: Lev-R-Vent Radiator Cap .....		
1997-1995: Pre-Vent Non-Locking Fuel Cap .....	10819		2010: OE Type Radiator Cap .....		
1997-1995: Regular Locking Fuel Cap .....	10591		2010: OE Equivalent Fuel Cap .....		
1997-1995: Pre-Vent Locking Fuel Cap .....	10501		2010: Regular Locking Fuel Cap .....		
1997-1995: Oil Filler Cap .....	10082		2010: Oil Filler Cap .....		
<b>Protege</b>			2009: Lev-R-Vent Radiator Cap .....		
<b>4-Cyl. 1.5 L</b>			2009: OE Type Radiator Cap .....		
1998-1995: Lev-R-Vent Radiator Cap; W/Auto. Trans. ....	✓10327	13	2009: OE Equivalent Fuel Cap .....		
1998-1995: OE Type Radiator Cap; W/Auto. Trans. ....	10227	13	2009: Regular Locking Fuel Cap .....		
1998-1995: OE Type Radiator Cap; W/Man. Trans. ....	10241	13	2009: Oil Filler Cap .....		
1998-1995: OE Equivalent Fuel Cap .....	10817		2008-2004: Lev-R-Vent Radiator Cap .....		
1998-1995: Pre-Vent Non-Locking Fuel Cap .....	10819		2008-2004: OE Type Radiator Cap .....		
1998-1995: Regular Locking Fuel Cap .....	10591		2008-2004: OE Equivalent Fuel Cap .....		
1998-1995: Pre-Vent Locking Fuel Cap .....	10501		2008-2004: Regular Locking Fuel Cap .....		
1998-1995: Oil Filler Cap .....	10082		2008-2004: Oil Filler Cap .....		
<b>4-Cyl. 1.6 L</b>			<b>Tribute</b>		
2001-2000: Lev-R-Vent Radiator Cap; W/Auto. Trans. ....	✓10333	16	<b>4-Cyl. 2.0 L</b>		
2001-2000: OE Type Radiator Cap; W/Auto. Trans. ....	10233	16	2004: OE Type Radiator Cap .....		
2001-2000: OE Type Radiator Cap; W/Man. Trans. ....	10242	16	2004: OE Equivalent Fuel Cap .....		
2001-2000: OE Equivalent Fuel Cap .....	10834		2004: Regular Locking Fuel Cap .....		
2001-2000: Regular Locking Fuel Cap .....	10504		2004: Oil Filler Cap .....		
2001-2000: Oil Filler Cap .....	10082		2003-2002: OE Type Radiator Cap .....		
1999: Lev-R-Vent Radiator Cap; W/Auto. Trans. ....	✓10327	13	2003-2002: OE Equivalent Fuel Cap .....		
1999: OE Type Radiator Cap; W/Auto. Trans. ....	10227	13	2003-2002: Regular Locking Fuel Cap .....		
1999: OE Type Radiator Cap; W/Man. Trans. ....	10241	13	2003-2002: Oil Filler Cap .....		
1999: OE Equivalent Fuel Cap .....	10834		2001: OE Type Radiator Cap .....		
1999: Regular Locking Fuel Cap .....	10504		2001: OE Equivalent Fuel Cap .....		
1999: Oil Filler Cap .....	10082		2001: Regular Locking Fuel Cap .....		
<b>4-Cyl. 1.8 L</b>			2001: Oil Filler Cap .....		
2000: Lev-R-Vent Radiator Cap; W/Auto. Trans. ....	✓10333	16			

✓ Check Hood Clearance prior to installing this Cap.

## Caps for Passenger Cars and Light Trucks (1990 and Newer)

Application	Part Number	PSI	Application	Part Number	PSI
<b>Mazda - Continued</b>			<b>Mercedes-Benz - Continued</b>		
<b>Tribute - Continued</b>			<b>C63 - Continued</b>		
<b>4-Cyl. 2.3 L</b>			<b>V-8 6.3 L - Continued</b>		
2008; OE Type Radiator Cap .....	10251	17	2010-2008; OE Equivalent Fuel Cap .....	10845	
2008; OE Equivalent Fuel Cap .....	10840		2010-2008; Oil Filler Cap .....	10130	
2008; Regular Locking Fuel Cap .....	10510		<b>C220</b>		
2008; Oil Filler Cap .....	10144		<b>4-Cyl. 2.2 L</b>		
2006-2005; OE Type Radiator Cap .....	10251	17	1996-1995; Lev-R-Vent Radiator Cap .....	10335	20
2006-2005; OE Equivalent Fuel Cap .....	10840		1996-1995; OE Type Radiator Cap .....	10235	20
2006-2005; Regular Locking Fuel Cap .....	10510		1996-1995; OE Equivalent Fuel Cap .....	10843	
2006-2005; Oil Filler Cap .....	10144		1996-1995; Oil Filler Cap .....	10130	
<b>4-Cyl. 2.3 L Electric Assist</b>			<b>C230</b>		
2008; OE Type Radiator Cap .....	10251	17	<b>4-Cyl. 1.8 L</b>		
2008; OE Equivalent Fuel Cap .....	10840		2005-2003; OE Type Radiator Cap .....	10253	21
2008; Regular Locking Fuel Cap .....	10510		2005-2003; OE Equivalent Fuel Cap .....	10843	
2008; Oil Filler Cap .....	10144		2005-2003; Oil Filler Cap .....	10130	
<b>4-Cyl. 2.5 L</b>			<b>4-Cyl. 2.3 L</b>		
2011-2010; OE Type Radiator Cap .....	10251	17	2002; OE Type Radiator Cap .....	10253	21
2011-2010; Oil Filler Cap .....	10144		2002; OE Equivalent Fuel Cap .....	10843	
2009; OE Type Radiator Cap .....	10251	17	2002; Oil Filler Cap .....	10130	
2009; OE Equivalent Fuel Cap .....	10840		2000-1999; Lev-R-Vent Radiator Cap .....	10335	20
2009; Regular Locking Fuel Cap .....	10510		2000-1999; OE Type Radiator Cap .....	10235	20
<b>4-Cyl. 2.5 L Electric Assist</b>			2000-1999; OE Equivalent Fuel Cap .....	10843	
2010; OE Type Radiator Cap .....	10251	17	2000-1999; Oil Filler Cap .....	10130	
2010; Oil Filler Cap .....	10144		1998-1997; Lev-R-Vent Radiator Cap .....	10335	20
2009; OE Type Radiator Cap .....	10251	17	1998-1997; OE Type Radiator Cap .....	10235	20
2009; OE Equivalent Fuel Cap .....	10840		1998-1997; OE Equivalent Fuel Cap .....	10843	
2009; Regular Locking Fuel Cap .....	10510		1998-1997; Oil Filler Cap .....	10079	
<b>V-6 3.0 L</b>			<b>V-6 2.5 L</b>		
2011-2010; OE Type Radiator Cap .....	10251	17	2007-2006; OE Type Radiator Cap .....	10253	21
2011-2010; Oil Filler Cap .....	10117		2007-2006; OE Equivalent Fuel Cap .....	10843	
2009; OE Type Radiator Cap .....	10251	17	2007-2006; Oil Filler Cap .....	10130	
2009; OE Equivalent Fuel Cap .....	10840		<b>C240</b>		
2009; Regular Locking Fuel Cap .....	10510		<b>V-6 2.6 L</b>		
2009; Oil Filler Cap .....	10117		2005-2001; OE Type Radiator Cap .....	10253	21
2008; OE Type Radiator Cap .....	10251	17	2005-2001; OE Equivalent Fuel Cap .....	10845	
2008; Oil Filler Cap .....	10117		2005-2001; Oil Filler Cap .....	10130	
2006-2005; OE Type Radiator Cap .....	10251	17	<b>C280</b>		
2006-2005; OE Equivalent Fuel Cap .....	10840		<b>6-Cyl. 2.8 L</b>		
2006-2005; Regular Locking Fuel Cap .....	10510		1997-1996; Lev-R-Vent Radiator Cap .....	10335	20
2006-2005; Oil Filler Cap .....	10117		1997-1996; OE Type Radiator Cap .....	10235	20
2004-2001; OE Type Radiator Cap .....	10251	17	1997-1996; OE Equivalent Fuel Cap .....	10843	
2004-2001; OE Equivalent Fuel Cap .....	10832		1997-1996; Oil Filler Cap .....	10079	
2004-2001; Regular Locking Fuel Cap .....	10502		1995; Lev-R-Vent Radiator Cap .....	10335	20
2004-2001; Oil Filler Cap .....	10117		1995; OE Type Radiator Cap .....	10235	20
<b>Mercedes-Benz</b>			1995; OE Equivalent Fuel Cap .....	10843	
<b>C32</b>			1995; Oil Filler Cap .....	10130	
<b>V-6 3.2 L</b>			<b>V-6 2.8 L</b>		
2004-2002; OE Type Radiator Cap .....	10253	21	2000; OE Type Radiator Cap .....	10253	21
2004-2002; OE Equivalent Fuel Cap .....	10845		2000; OE Equivalent Fuel Cap .....	10845	
2004-2002; Oil Filler Cap .....	10130		2000; Oil Filler Cap .....	10130	
<b>C36</b>			1999; OE Type Radiator Cap .....	10253	21
<b>6-Cyl. 3.6 L</b>			1999; OE Equivalent Fuel Cap .....	10843	
1997-1995; Lev-R-Vent Radiator Cap .....	10335	20	1999; Oil Filler Cap .....	10130	
1997-1995; OE Type Radiator Cap .....	10235	20	1998; OE Type Radiator Cap .....	10253	21
1997-1995; OE Equivalent Fuel Cap .....	10843		1998; OE Equivalent Fuel Cap .....	10843	
1997-1995; Oil Filler Cap .....	10079		1998; Oil Filler Cap .....	10079	
<b>C43</b>			<b>V-6 3.0 L</b>		
<b>V-8 4.3 L</b>			2007-2006; OE Type Radiator Cap .....	10253	21
2000-1998; OE Equivalent Fuel Cap .....	10843		2007-2006; OE Equivalent Fuel Cap .....	10845	
2000-1998; Oil Filler Cap .....	10130		2007-2006; Oil Filler Cap .....	10130	
<b>C55</b>			<b>C300</b>		
<b>V-8 5.5 L</b>			<b>V-6 3.0 L</b>		
2006-2005; OE Type Radiator Cap .....	10253	21	2010-2009; OE Type Radiator Cap .....	10253	21
2006-2005; OE Equivalent Fuel Cap .....	10845		2010-2009; OE Equivalent Fuel Cap .....	10845	
2006-2005; Oil Filler Cap .....	10130		2008; OE Type Radiator Cap .....	10253	21
<b>C63</b>			2008; OE Equivalent Fuel Cap .....	10845	
<b>V-8 6.3 L</b>			2008; Oil Filler Cap .....	10130	
2010-2008; OE Type Radiator Cap .....	10253	21			

## Caps for Passenger Cars and Light Trucks (1990 and Newer)

Application	Part Number	PSI	Application	Part Number	PSI
<b>Mercedes-Benz - Continued</b>			<b>Mercedes-Benz - Continued</b>		
<b>C320</b>			<b>CL600 - Continued</b>		
<b>V-6 3.2 L</b>			<b>V-12 5.5 L - Continued</b>		
2005-2001: OE Type Radiator Cap .....	10253	21	2008-2007: Coolant Recovery Tank Cap .....	10253	
2005-2001: OE Equivalent Fuel Cap .....	10845		2008-2007: OE Equivalent Fuel Cap .....	10845	
2005-2001: Oil Filler Cap .....	10130		2008-2007: Oil Filler Cap .....	10130	
<b>C350</b>			2006: Lev-R-Vent Radiator Cap .....	10335	20
<b>V-6 3.5 L</b>			2006: OE Type Radiator Cap .....	10235	20
2011: OE Equivalent Fuel Cap .....	10838		2006: Coolant Recovery Tank Cap .....	10253	
2011: Regular Locking Fuel Cap .....	10508		2006: OE Equivalent Fuel Cap .....	10843	
2010-2009: OE Type Radiator Cap .....	10253	21	2006: Oil Filler Cap .....	10130	
2010-2009: OE Equivalent Fuel Cap .....	10845		2005: OE Type Radiator Cap .....	10235	20
2008-2006: OE Type Radiator Cap .....	10253	21	2005: Lev-R-Vent Radiator Cap .....	10335	20
2008-2006: OE Equivalent Fuel Cap .....	10845		2005: Coolant Recovery Tank Cap .....	10253	
2008-2006: Oil Filler Cap .....	10130		2005: OE Equivalent Fuel Cap .....	10843	
<b>CL55</b>			2005: Oil Filler Cap .....	10130	
<b>V-8 5.5 L</b>			2004-2003: Lev-R-Vent Radiator Cap .....	10335	20
2006-2001: OE Type Radiator Cap .....	10253	21	2004-2003: OE Type Radiator Cap .....	10235	20
2006-2001: OE Equivalent Fuel Cap .....	10843		2004-2003: Coolant Recovery Tank Cap .....	10253	
2006-2001: Oil Filler Cap .....	10130		2004-2003: OE Equivalent Fuel Cap .....	10843	
<b>CL63</b>			<b>V-12 5.8 L</b>		
<b>V-8 6.3 L</b>			2002: OE Type Radiator Cap .....	10253	21
2010-2008: OE Type Radiator Cap .....	10253	21	2002: OE Equivalent Fuel Cap .....	10843	
2010-2008: OE Equivalent Fuel Cap .....	10845		2002: Oil Filler Cap .....	10130	
2010-2008: Oil Filler Cap .....	10130		2001: OE Type Radiator Cap .....	10253	21
2007: OE Equivalent Fuel Cap .....	10845		2001: OE Equivalent Fuel Cap .....	10843	
2007: Oil Filler Cap .....	10130		<b>V-12 6.0 L</b>		
<b>CL65</b>			1999-1998: OE Type Radiator Cap .....	10253	21
<b>V-12 6.0 L</b>			<b>CLK55</b>		
2010: OE Type Radiator Cap .....	10253	21	<b>V-8 5.5 L</b>		
2010: OE Equivalent Fuel Cap .....	10845		2006-2003: OE Type Radiator Cap .....	10253	21
2009: Lev-R-Vent Radiator Cap .....	10335	20	2006-2003: OE Equivalent Fuel Cap .....	10845	
2009: OE Type Radiator Cap .....	10235	20	2006-2003: Oil Filler Cap .....	10130	
2009: Coolant Recovery Tank Cap .....	10253		2002-2001: OE Type Radiator Cap .....	10253	21
2009: OE Equivalent Fuel Cap .....	10845		2002-2001: OE Equivalent Fuel Cap .....	10843	
2008: OE Type Radiator Cap .....	10253	21	2002-2001: Oil Filler Cap .....	10130	
2008: OE Equivalent Fuel Cap .....	10843		<b>CLK63</b>		
2008: Oil Filler Cap .....	10130		<b>V-8 6.3 L</b>		
2006-2005: OE Type Radiator Cap .....	10253	21	2009-2007: OE Type Radiator Cap .....	10253	21
2006-2005: OE Equivalent Fuel Cap .....	10843		2009-2007: OE Equivalent Fuel Cap .....	10845	
2006-2005: Oil Filler Cap .....	10130		2009-2007: Oil Filler Cap .....	10130	
<b>CL500</b>			<b>CLK320</b>		
<b>V-8 5.0 L</b>			<b>V-6 3.2 L</b>		
2006-2000: OE Type Radiator Cap .....	10253	21	2005-2001: OE Type Radiator Cap .....	10253	21
2006-2000: OE Equivalent Fuel Cap .....	10843		2005-2001: OE Equivalent Fuel Cap .....	10843	
2006-2000: Oil Filler Cap .....	10130		2005-2001: Oil Filler Cap .....	10130	
1999: OE Equivalent Fuel Cap .....	10843		2000-1998: OE Type Radiator Cap .....	10253	21
1999: Oil Filler Cap .....	10079		2000-1998: OE Equivalent Fuel Cap .....	10843	
1998: OE Equivalent Fuel Cap .....	10843		2000-1998: Oil Filler Cap .....	10079	
1998: Oil Filler Cap .....	10130		<b>CLK350</b>		
<b>CL550</b>			<b>V-6 3.5 L</b>		
<b>V-8 5.5 L</b>			2009: OE Type Radiator Cap .....	10253	21
2010: OE Type Radiator Cap .....	10253	21	2009: OE Equivalent Fuel Cap .....	10845	
2010: OE Equivalent Fuel Cap .....	10845		2008-2006: OE Type Radiator Cap .....	10253	21
2009: OE Type Radiator Cap .....	10253	21	2008-2006: OE Equivalent Fuel Cap .....	10845	
2008-2007: OE Type Radiator Cap .....	10253	21	2008-2006: Oil Filler Cap .....	10130	
2008-2007: OE Equivalent Fuel Cap .....	10845		<b>CLK430</b>		
2008-2007: Oil Filler Cap .....	10130		<b>V-8 4.3 L</b>		
<b>CL600</b>			2003-1999: OE Type Radiator Cap .....	10253	21
<b>V-12 5.5 L</b>			2003-1999: OE Equivalent Fuel Cap .....	10843	
2010: Lev-R-Vent Radiator Cap .....	10335	20	2003-1999: Oil Filler Cap .....	10130	
2010: OE Type Radiator Cap .....	10235	20	<b>CLK500</b>		
2010: Coolant Recovery Tank Cap .....	10253		<b>V-8 5.0 L</b>		
2009: Lev-R-Vent Radiator Cap .....	10335	20	2006-2003: OE Type Radiator Cap .....	10253	21
2009: OE Type Radiator Cap .....	10235	20	2006-2003: OE Equivalent Fuel Cap .....	10845	
2009: Coolant Recovery Tank Cap .....	10253		2006-2003: Oil Filler Cap .....	10130	
2009: OE Equivalent Fuel Cap .....	10845		<b>CLK550</b>		
2008-2007: Lev-R-Vent Radiator Cap .....	10335	20	<b>V-8 5.5 L</b>		
2008-2007: OE Type Radiator Cap .....	10235	20	2009: OE Type Radiator Cap .....	10253	21

## Caps for Passenger Cars and Light Trucks (1990 and Newer)

Application	Part Number	PSI	Application	Part Number	PSI
<b>Mercedes-Benz - Continued</b>			<b>Mercedes-Benz - Continued</b>		
<b>CLK550 - Continued</b>			<b>E320 - Continued</b>		
<b>V-8 5.5 L - Continued</b>			<b>6-Cyl. 3.2 L - Continued</b>		
2009; OE Equivalent Fuel Cap .....	10845		1995; Lev-R-Vent Radiator Cap .....	10335	20
2008-2007; OE Type Radiator Cap .....	10253	21	1995; OE Type Radiator Cap .....	10235	20
2008-2007; OE Equivalent Fuel Cap .....	10845		1995; OE Equivalent Fuel Cap .....	10843	
2008-2007; Oil Filler Cap .....	10130		1995; Oil Filler Cap .....	10079	
<b>CLS55</b>			<b>6-Cyl. 3.2 L Diesel</b>		
<b>V-8 5.5 L</b>			2006; OE Type Radiator Cap .....		
2006; OE Type Radiator Cap .....	10253	21	2006; OE Equivalent Fuel Cap .....	10845	21
2006; OE Equivalent Fuel Cap .....	10845		2006; Oil Filler Cap .....	10130	
2006; Oil Filler Cap .....	10130		2005; OE Type Radiator Cap .....	10253	21
<b>CLS63</b>			2005; OE Equivalent Fuel Cap .....		
<b>V-8 6.3 L</b>			2005; Oil Filler Cap .....		
2011; OE Equivalent Fuel Cap .....	10845		<b>V-6 3.0 L Diesel</b>		
2010-2007; OE Type Radiator Cap .....	10253	21	2009; OE Type Radiator Cap .....		
2010-2007; OE Equivalent Fuel Cap .....	10845		2009; OE Equivalent Fuel Cap .....		
2010-2007; Oil Filler Cap .....	10130		2008-2007; OE Type Radiator Cap .....		
<b>CLS500</b>			2008-2007; OE Equivalent Fuel Cap .....		
<b>V-8 5.0 L</b>			2008-2007; Oil Filler Cap .....		
2006; OE Type Radiator Cap .....	10253	21	<b>V-6 3.2 L</b>		
2006; OE Equivalent Fuel Cap .....	10845		2005-2003; OE Type Radiator Cap .....		
2006; Oil Filler Cap .....	10130		2005-2003; OE Equivalent Fuel Cap .....		
<b>CLS550</b>			2005-2003; Oil Filler Cap .....		
<b>V-8 5.5 L</b>			2002-1998; OE Type Radiator Cap .....		
2010-2009; OE Type Radiator Cap .....	10253	21	2002-1998; OE Equivalent Fuel Cap .....		
2010-2009; OE Equivalent Fuel Cap .....	10845		2002-1998; Oil Filler Cap .....		
2008; OE Type Radiator Cap .....	10253	21	<b>E350</b>		
2008; OE Equivalent Fuel Cap .....	10845		<b>V-6 3.5 L</b>		
2008; Oil Filler Cap .....	10130		2011; OE Equivalent Fuel Cap .....		
2007; OE Type Radiator Cap .....	10253	21	2010-2009; OE Type Radiator Cap .....		
2007; OE Equivalent Fuel Cap .....	10845		2010-2009; OE Equivalent Fuel Cap .....		
<b>E55</b>			2008-2006; OE Type Radiator Cap .....		
<b>V-8 5.5 L</b>			2008-2006; OE Equivalent Fuel Cap .....		
2006-2003; OE Type Radiator Cap .....	10253	21	2008-2006; Oil Filler Cap .....		
2006-2003; OE Equivalent Fuel Cap .....	10845		<b>E420</b>		
2006-2003; Oil Filler Cap .....	10130		<b>V-8 4.2 L</b>		
2002-1999; OE Type Radiator Cap .....	10253	21	1997; OE Type Radiator Cap .....		
2002-1999; OE Equivalent Fuel Cap .....	10843		1997; OE Equivalent Fuel Cap .....		
2002-1999; Oil Filler Cap .....	10130		1997; Oil Filler Cap .....		
<b>E63</b>			1995; Lev-R-Vent Radiator Cap .....		
<b>V-8 6.3 L</b>			1995; OE Type Radiator Cap .....		
2010-2007; OE Type Radiator Cap .....	10253	21	1995; OE Equivalent Fuel Cap .....		
2010-2007; OE Equivalent Fuel Cap .....	10845		1995; Oil Filler Cap .....		
2010-2007; Oil Filler Cap .....	10130		<b>E430</b>		
<b>E300</b>			<b>V-8 4.3 L</b>		
<b>6-Cyl. 3.0 L Diesel</b>			2002-1998; OE Type Radiator Cap .....		
1999; OE Equivalent Fuel Cap .....	10843		2002-1998; OE Equivalent Fuel Cap .....		
1999; Oil Filler Cap .....	10079		2002-1998; Oil Filler Cap .....		
1998; Oil Filler Cap .....	10079		<b>E500</b>		
<b>E300D</b>			<b>V-8 5.0 L</b>		
<b>6-Cyl. 3.0 L Diesel</b>			2006-2003; OE Type Radiator Cap .....		
1997; OE Type Radiator Cap .....	10253	21	2006-2003; OE Equivalent Fuel Cap .....		
1997; OE Equivalent Fuel Cap .....	10843		2006-2003; Oil Filler Cap .....		
1997; Oil Filler Cap .....	10079		<b>E550</b>		
1996; OE Type Radiator Cap .....	10253	21	<b>V-8 5.5 L</b>		
1996; OE Equivalent Fuel Cap .....	10843		2010-2009; OE Type Radiator Cap .....		
1996; Oil Filler Cap .....	10130		2010-2009; OE Equivalent Fuel Cap .....		
1995; Lev-R-Vent Radiator Cap .....	10335	20	2008-2007; OE Type Radiator Cap .....		
1995; OE Type Radiator Cap .....	10235	20	2008-2007; OE Equivalent Fuel Cap .....		
1995; OE Equivalent Fuel Cap .....	10810		2008-2007; Oil Filler Cap .....		
1995; Oil Filler Cap .....	10079		<b>G55</b>		
<b>E320</b>			<b>V-8 5.5 L</b>		
<b>6-Cyl. 3.2 L</b>			2010; OE Type Radiator Cap .....		
1997-1996; OE Type Radiator Cap .....	10253	21	2010; OE Equivalent Fuel Cap .....		
1997-1996; OE Equivalent Fuel Cap .....	10843		2009-2003; OE Type Radiator Cap .....		
1997-1996; Oil Filler Cap .....	10079		2009-2003; OE Equivalent Fuel Cap .....		
			2009-2003; Oil Filler Cap .....		

## Caps for Passenger Cars and Light Trucks (1990 and Newer)

Application	Part Number	PSI	Application	Part Number	PSI
<b>Mercedes-Benz - Continued</b>			<b>Mercedes-Benz - Continued</b>		
<b>G500</b>			<b>ML63</b>		
V-8 5.0 L			V-8 6.3 L		
2008-2002; OE Type Radiator Cap .....	10253	21	2011; OE Equivalent Fuel Cap .....	10838	
2008-2002; OE Equivalent Fuel Cap .....	10845		2011; Regular Locking Fuel Cap .....	10508	
2008-2002; Oil Filler Cap .....	10130		2010-2007; OE Type Radiator Cap .....	10253	21
<b>G550</b>			2010-2007; OE Equivalent Fuel Cap .....	10838	
V-8 5.5 L			2010-2007; Regular Locking Fuel Cap .....	10508	
2010; OE Type Radiator Cap .....	10253	21	2010-2007; Oil Filler Cap .....	10130	
2010; OE Equivalent Fuel Cap .....	10845		<b>ML320</b>		
2009; OE Type Radiator Cap .....	10253	21	V-6 3.0 L Diesel		
2009; OE Equivalent Fuel Cap .....	10845		2009-2007; OE Type Radiator Cap .....	10253	21
2009; Oil Filler Cap .....	10130		2009-2007; OE Equivalent Fuel Cap .....	10838	
<b>GL320</b>			2009-2007; Diesel Regular Non-Locking Fuel Cap .....	10838D	
V-6 3.0 L Diesel			2009-2007; Regular Locking Fuel Cap .....	10508	
2009; OE Type Radiator Cap .....	10253	21	2009-2007; Diesel Regular Locking Fuel Cap .....	10508D	
2009; OE Equivalent Fuel Cap .....	10838		2009-2007; Oil Filler Cap .....	10130	
2009; Diesel Regular Non-Locking Fuel Cap .....	10838D		V-6 3.2 L		
2009; Regular Locking Fuel Cap .....	10508		2003-2000; OE Type Radiator Cap .....	10258	20
2009; Diesel Regular Locking Fuel Cap .....	10508D		2003-2000; OE Equivalent Fuel Cap .....	10834	
2008-2007; OE Type Radiator Cap .....	10253	21	2003-2000; Regular Locking Fuel Cap .....	10504	
2008-2007; OE Equivalent Fuel Cap .....	10838		2003-2000; Oil Filler Cap .....	10130	
2008-2007; Diesel Regular Non-Locking Fuel Cap .....	10838D		1999-1998; OE Type Radiator Cap .....	10258	20
2008-2007; Regular Locking Fuel Cap .....	10508		1999-1998; OE Equivalent Fuel Cap .....	10834	
2008-2007; Diesel Regular Locking Fuel Cap .....	10508D		1999-1998; Regular Locking Fuel Cap .....	10504	
2008-2007; Oil Filler Cap .....	10130		1999-1998; Oil Filler Cap .....	10079	
<b>GL350</b>			<b>ML350</b>		
V-6 3.0 L Diesel			V-6 3.0 L Diesel		
2010; OE Type Radiator Cap .....	10253	21	2010; OE Type Radiator Cap .....	10253	21
2010; OE Equivalent Fuel Cap .....	10838		2010; OE Equivalent Fuel Cap .....	10838	
2010; Regular Locking Fuel Cap .....	10508		2010; Regular Locking Fuel Cap .....	10508	
<b>GL450</b>			V-6 3.5 L		
V-8 4.7 L			2011; OE Equivalent Fuel Cap .....	10838	
2011; OE Equivalent Fuel Cap .....	10838		2011; Regular Locking Fuel Cap .....	10508	
2011; Regular Locking Fuel Cap .....	10508		2010; OE Type Radiator Cap .....	10253	21
2010-2009; OE Type Radiator Cap .....	10253	21	2010; OE Equivalent Fuel Cap .....	10838	
2010-2009; OE Equivalent Fuel Cap .....	10838		2010; Regular Locking Fuel Cap .....	10508	
2010-2009; Regular Locking Fuel Cap .....	10508		2009-2006; OE Type Radiator Cap .....	10253	21
2008-2007; OE Type Radiator Cap .....	10253	21	2009-2006; OE Equivalent Fuel Cap .....	10838	
2008-2007; OE Equivalent Fuel Cap .....	10838		2009-2006; Regular Locking Fuel Cap .....	10508	
2008-2007; Regular Locking Fuel Cap .....	10508		2009-2006; Oil Filler Cap .....	10130	
2008-2007; Oil Filler Cap .....	10130		V-6 3.7 L		
<b>GL550</b>			2005-2003; OE Type Radiator Cap .....	10258	20
V-8 5.5 L			2005-2003; OE Equivalent Fuel Cap .....	10834	
2011; OE Equivalent Fuel Cap .....	10838		2005-2003; Regular Locking Fuel Cap .....	10504	
2011; Regular Locking Fuel Cap .....	10508		2005-2003; Oil Filler Cap .....	10130	
2010-2009; OE Type Radiator Cap .....	10253	21	<b>ML430</b>		
2010-2009; OE Equivalent Fuel Cap .....	10838		V-8 4.3 L		
2010-2009; Regular Locking Fuel Cap .....	10508		2001; OE Type Radiator Cap .....	10258	20
2008; OE Type Radiator Cap .....	10253	21	2001; OE Equivalent Fuel Cap .....	10834	
2008; OE Equivalent Fuel Cap .....	10838		2001; Regular Locking Fuel Cap .....	10504	
2008; Regular Locking Fuel Cap .....	10508		2001; Oil Filler Cap .....	10130	
2008; Oil Filler Cap .....	10130		2000; OE Type Radiator Cap .....	10258	20
<b>GLK350</b>			2000; OE Equivalent Fuel Cap .....	10834	
V-6 3.5 L			2000; Regular Locking Fuel Cap .....	10504	
2010; OE Type Radiator Cap .....	10253	21	2000; Oil Filler Cap .....	10079	
2010; OE Equivalent Fuel Cap .....	10845		1999; OE Type Radiator Cap .....	10258	20
2010; Oil Filler Cap .....	10130		1999; OE Equivalent Fuel Cap .....	10834	
<b>ML55</b>			1999; Regular Locking Fuel Cap .....	10504	
V-8 5.5 L			1999; Oil Filler Cap .....	10130	
2003; OE Type Radiator Cap .....	10258	20	<b>ML450</b>		
2003; Oil Filler Cap .....	10130		V-6 3.5 L Electric Assist		
2002-2000; OE Type Radiator Cap .....	10258	20	2010; OE Type Radiator Cap .....	10253	21
2002-2000; OE Equivalent Fuel Cap .....	10834		<b>ML500</b>		
2002-2000; Regular Locking Fuel Cap .....	10504		V-8 5.0 L		
2002-2000; Oil Filler Cap .....	10130		2007-2006; OE Type Radiator Cap .....	10253	21
			2007-2006; OE Equivalent Fuel Cap .....	10838	
			2007-2006; Regular Locking Fuel Cap .....	10508	
			2007-2006; Oil Filler Cap .....	10130	
			2005-2003; OE Type Radiator Cap .....	10258	20

## Caps for Passenger Cars and Light Trucks (1990 and Newer)

Application	Part Number	PSI	Application	Part Number	PSI
<b>Mercedes-Benz - Continued</b>			<b>Mercedes-Benz - Continued</b>		
<b>ML500 - Continued</b>			<b>S63</b>		
<b>V-8 5.0 L - Continued</b>			<b>V-8 6.3 L</b>		
2005-2003: OE Equivalent Fuel Cap .....	10834		2010-2008: OE Type Radiator Cap .....	10253	21
2005-2003: Regular Locking Fuel Cap .....	10504		2010-2008: OE Equivalent Fuel Cap .....	10845	
2005-2003: Oil Filler Cap .....	10130		2010-2008: Oil Filler Cap .....	10130	
2002: OE Type Radiator Cap .....	10258	20	2007: OE Equivalent Fuel Cap .....	10845	
2002: OE Equivalent Fuel Cap .....	10834		<b>S65</b>		
2002: Regular Locking Fuel Cap .....	10504		<b>V-12 6.0 L</b>		
2002: Oil Filler Cap .....	10079		2011: OE Equivalent Fuel Cap .....	10845	
<b>ML550</b>			2010-2009: Lev-R-Vent Radiator Cap .....	10335	20
<b>V-8 5.5 L</b>			2010-2009: OE Type Radiator Cap .....	10235	20
2011: OE Equivalent Fuel Cap .....	10838		2010-2009: Coolant Recovery Tank Cap .....	10253	
2011: Regular Locking Fuel Cap .....	10508		2010-2009: OE Equivalent Fuel Cap .....	10845	
2010: OE Type Radiator Cap .....	10253	21	2010-2009: Oil Filler Cap .....	10130	
2010: OE Equivalent Fuel Cap .....	10838		2008-2006: OE Type Radiator Cap .....	10253	21
2010: Regular Locking Fuel Cap .....	10508		2008-2006: OE Equivalent Fuel Cap .....	10845	
2009: OE Type Radiator Cap .....	10253	21	2008-2006: Oil Filler Cap .....	10130	
2009: OE Equivalent Fuel Cap .....	10834		<b>S320</b>		
2009: Regular Locking Fuel Cap .....	10504		<b>6-Cyl. 3.2 L</b>		
2008: OE Type Radiator Cap .....	10253	21	1999-1998: OE Type Radiator Cap .....	10253	21
2008: OE Equivalent Fuel Cap .....	10838		1999-1998: OE Equivalent Fuel Cap .....	10843	
2008: Regular Locking Fuel Cap .....	10508		1999-1998: Oil Filler Cap .....	10079	
2008: Oil Filler Cap .....	10130		1997-1995: Lev-R-Vent Radiator Cap .....	10335	20
<b>R63</b>			1997-1995: OE Type Radiator Cap .....	10235	20
<b>V-8 6.3 L</b>			1997-1995: OE Equivalent Fuel Cap .....	10843	
2007: OE Type Radiator Cap .....	10253	21	1997-1995: Oil Filler Cap .....	10079	
2007: OE Equivalent Fuel Cap .....	10838		<b>S350</b>		
2007: Regular Locking Fuel Cap .....	10508		<b>V-6 3.7 L</b>		
2007: Oil Filler Cap .....	10130		2006: OE Type Radiator Cap .....	10253	21
<b>R320</b>			2006: OE Equivalent Fuel Cap .....	10845	
<b>V-6 3.0 L Diesel</b>			2006: Oil Filler Cap .....	10130	
2009: OE Type Radiator Cap .....	10253	21	<b>S350D</b>		
2009: OE Equivalent Fuel Cap .....	10838		<b>6-Cyl. 3.5 L Diesel</b>		
2009: Diesel Regular Non-Locking Fuel Cap .....	10838D		1995: OE Equivalent Fuel Cap .....	10843	
2009: Regular Locking Fuel Cap .....	10508		<b>S400</b>		
2009: Diesel Regular Locking Fuel Cap .....	10508D		<b>V-6 3.5 L Electric Assist</b>		
2008: OE Type Radiator Cap .....	10253	21	2011: OE Equivalent Fuel Cap .....	10845	
2008: OE Equivalent Fuel Cap .....	10838		2010: OE Type Radiator Cap .....	10253	21
2008: Regular Locking Fuel Cap .....	10508		2010: OE Equivalent Fuel Cap .....	10845	
2008: Diesel Regular Non-Locking Fuel Cap .....	10838D		<b>S420</b>		
2008: Diesel Regular Locking Fuel Cap .....	10508D		<b>V-8 4.2 L</b>		
2008: Oil Filler Cap .....	10130		1999-1998: OE Type Radiator Cap .....	10253	21
2007: OE Type Radiator Cap .....	10253	21	1999-1998: OE Equivalent Fuel Cap .....	10843	
2007: OE Equivalent Fuel Cap .....	10838		1999-1998: Oil Filler Cap .....	10130	
2007: Diesel Regular Non-Locking Fuel Cap .....	10838D		1997-1995: Lev-R-Vent Radiator Cap .....	10335	20
2007: Regular Locking Fuel Cap .....	10508		1997-1995: OE Type Radiator Cap .....	10235	20
2007: Diesel Regular Locking Fuel Cap .....	10508D		1997-1995: OE Equivalent Fuel Cap .....	10843	
2007: Oil Filler Cap .....	10130		1997-1995: Oil Filler Cap .....	10130	
<b>R350</b>			<b>S430</b>		
<b>V-6 3.0 L Diesel</b>			<b>V-8 4.3 L</b>		
2010: OE Type Radiator Cap .....	10253	21	2006-2000: OE Type Radiator Cap .....	10253	21
2010: OE Equivalent Fuel Cap .....	10838		2006-2000: OE Equivalent Fuel Cap .....	10843	
2010: Regular Locking Fuel Cap .....	10508		2006-2000: Oil Filler Cap .....	10130	
<b>V-6 3.5 L</b>			<b>S500</b>		
2010-2006: OE Type Radiator Cap .....	10253	21	<b>V-8 5.0 L</b>		
2010-2006: OE Equivalent Fuel Cap .....	10838		2006-2000: OE Type Radiator Cap .....	10253	21
2010-2006: Regular Locking Fuel Cap .....	10508		2006-2000: OE Equivalent Fuel Cap .....	10843	
2010-2006: Oil Filler Cap .....	10130		2006-2000: Oil Filler Cap .....	10130	
<b>R500</b>			1999-1998: OE Type Radiator Cap .....	10253	21
<b>V-8 5.0 L</b>			1999-1998: OE Equivalent Fuel Cap .....	10843	
2007-2006: OE Type Radiator Cap .....	10253	21	1999-1998: Oil Filler Cap .....	10079	
2007-2006: OE Equivalent Fuel Cap .....	10838		1997-1996: Lev-R-Vent Radiator Cap .....	10335	20
2007-2006: Regular Locking Fuel Cap .....	10508		1997-1996: OE Type Radiator Cap .....	10235	20
2007-2006: Oil Filler Cap .....	10130		1997-1996: OE Equivalent Fuel Cap .....	10843	
<b>S55</b>			1997-1996: Oil Filler Cap .....	10079	
<b>V-8 5.5 L</b>			1995: Lev-R-Vent Radiator Cap .....	10335	20
2006-2001: OE Type Radiator Cap .....	10253	21	1995: OE Type Radiator Cap .....	10235	20
2006-2001: OE Equivalent Fuel Cap .....	10843				
2006-2001: Oil Filler Cap .....	10130				

## Caps for Passenger Cars and Light Trucks (1990 and Newer)

Application	Part Number	PSI	Application	Part Number	PSI
<b>Mercedes-Benz - Continued</b>			<b>Mercedes-Benz - Continued</b>		
<b>S500 - Continued</b>			<b>SL500 - Continued</b>		
V-8 5.0 L - Continued			V-8 5.0 L - Continued		
1995: OE Equivalent Fuel Cap .....	10843		2002-2000: OE Type Radiator Cap .....	10253	21
1995: Oil Filler Cap .....	10130		2002-2000: OE Equivalent Fuel Cap .....	10843	
<b>S550</b>			2002-2000: Oil Filler Cap .....		
V-8 5.5 L			2002-2000: Oil Filler Cap .....		
2011: OE Equivalent Fuel Cap .....	10845		1999-1998: OE Type Radiator Cap .....	10253	21
2010-2009: OE Type Radiator Cap .....	10253	21	1999-1998: OE Equivalent Fuel Cap .....	10843	
2010-2009: OE Equivalent Fuel Cap .....	10845		1999-1998: Oil Filler Cap .....	10079	
2008-2007: OE Type Radiator Cap .....	10253	21	1997-1995: Lev-R-Vent Radiator Cap .....	10335	20
2008-2007: OE Equivalent Fuel Cap .....	10845		1997-1995: OE Type Radiator Cap .....	10235	20
2008-2007: Oil Filler Cap .....	10130		1997-1995: OE Equivalent Fuel Cap .....	10843	
<b>S600</b>			1997-1995: Oil Filler Cap .....		
V-12 5.5 L			<b>SL550</b>		
2011: OE Equivalent Fuel Cap .....	10845		V-8 5.5 L		
2010-2009: Lev-R-Vent Radiator Cap .....	10335	20	2011: OE Equivalent Fuel Cap .....	10845	
2010-2009: OE Type Radiator Cap .....	10235	20	2011: Oil Filler Cap .....	10130	
2010-2009: Coolant Recovery Tank Cap .....	10253		2009-2007: OE Type Radiator Cap .....	10253	21
2010-2009: OE Equivalent Fuel Cap .....	10845		2009-2007: OE Equivalent Fuel Cap .....	10845	
2008-2003: OE Type Radiator Cap .....	10253	21	2009-2007: Oil Filler Cap .....	10130	
2008-2003: OE Equivalent Fuel Cap .....	10845		<b>SL600</b>		
2008-2003: Oil Filler Cap .....	10130		V-12 5.5 L		
V-12 5.8 L			2009: Lev-R-Vent Radiator Cap .....		
2002: OE Type Radiator Cap .....	10253	21	2009: OE Type Radiator Cap .....	10335	20
2002: OE Equivalent Fuel Cap .....	10845		2009: Coolant Recovery Tank Cap .....	10253	
2002: Oil Filler Cap .....	10079		2009: OE Equivalent Fuel Cap .....	10845	
2001: OE Type Radiator Cap .....	10253	21	2009: Oil Filler Cap .....	10130	
2001: OE Equivalent Fuel Cap .....	10843		2008-2004: OE Type Radiator Cap .....	10253	21
2001: Oil Filler Cap .....	10079		2008-2004: OE Equivalent Fuel Cap .....	10845	
V-12 6.0 L			2008-2004: Oil Filler Cap .....		
1999-1995: Lev-R-Vent Radiator Cap .....	10335	20	V-12 6.0 L		
1999-1995: OE Type Radiator Cap .....	10235	20	2002-2000: OE Type Radiator Cap .....	10253	21
1999-1995: OE Equivalent Fuel Cap .....	10843		2002-2000: OE Equivalent Fuel Cap .....	10843	
1999-1995: Oil Filler Cap .....	10079		2002-2000: Oil Filler Cap .....	10130	
<b>SL55</b>			1999-1998: OE Type Radiator Cap .....		
V-8 5.5 L			1999-1998: OE Equivalent Fuel Cap .....		
2008-2003: OE Type Radiator Cap .....	10253	21	1999-1998: Oil Filler Cap .....	10079	
2008-2003: OE Equivalent Fuel Cap .....	10845		1997-1995: Lev-R-Vent Radiator Cap .....	10335	20
2008-2003: Oil Filler Cap .....	10130		1997-1995: OE Type Radiator Cap .....	10235	20
<b>SL63</b>			1997-1995: OE Equivalent Fuel Cap .....		
V-8 6.3 L			1997-1995: Oil Filler Cap .....		
2011: OE Equivalent Fuel Cap .....	10845		<b>SLK32</b>		
2011: Oil Filler Cap .....	10130		V-6 3.2 L		
2009: OE Type Radiator Cap .....	10253	21	2004-2002: OE Type Radiator Cap .....	10253	21
2009: OE Equivalent Fuel Cap .....	10845		2004-2002: OE Equivalent Fuel Cap .....	10843	
2009: Oil Filler Cap .....	10130		2004-2002: Oil Filler Cap .....	10130	
<b>SL65</b>			<b>SLK55</b>		
V-12 6.0 L			V-8 5.5 L		
2011: OE Equivalent Fuel Cap .....	10845		2010: OE Type Radiator Cap .....	10253	21
2009: Lev-R-Vent Radiator Cap .....	10335	20	2009-2005: OE Type Radiator Cap .....	10253	21
2009: OE Type Radiator Cap .....	10235	20	2009-2005: OE Equivalent Fuel Cap .....	10845	
2009: Coolant Recovery Tank Cap .....	10253		2009-2005: Oil Filler Cap .....	10130	
2009: OE Equivalent Fuel Cap .....	10845		<b>SLK230</b>		
2009: Oil Filler Cap .....	10130		4-Cyl. 2.3 L		
2008-2005: OE Type Radiator Cap .....	10253	21	2004-2000: Lev-R-Vent Radiator Cap .....	10335	20
2008-2005: OE Equivalent Fuel Cap .....	10845		2004-2000: OE Type Radiator Cap .....	10235	20
2008-2005: Oil Filler Cap .....	10130		2004-2000: OE Equivalent Fuel Cap .....	10843	
<b>SL320</b>			2004-2000: Oil Filler Cap .....		
6-Cyl. 3.2 L			1999-1998: Lev-R-Vent Radiator Cap .....		
1997-1995: Lev-R-Vent Radiator Cap .....	10335	20	1999-1998: OE Type Radiator Cap .....	10235	20
1997-1995: OE Type Radiator Cap .....	10235	20	1999-1998: OE Equivalent Fuel Cap .....	10843	
1997-1995: OE Equivalent Fuel Cap .....	10843		1999-1998: Oil Filler Cap .....	10079	
1997-1995: Oil Filler Cap .....	10079		<b>SLK280</b>		
<b>SL500</b>			V-6 3.0 L		
V-8 5.0 L			2008-2006: OE Type Radiator Cap .....		
2006-2003: OE Type Radiator Cap .....	10253	21	2008-2006: OE Equivalent Fuel Cap .....	10845	
2006-2003: OE Equivalent Fuel Cap .....	10845		2008-2006: Oil Filler Cap .....	10130	
2006-2003: Oil Filler Cap .....	10130				



## Caps for Passenger Cars and Light Trucks (1990 and Newer)

Application	Part Number	PSI	Application	Part Number	PSI
<b>Mercedes-Benz - Continued</b>			<b>Mercury - Continued</b>		
<b>SLK300</b>			<b>Grand Marquis - Continued</b>		
V-6 3.0 L			V-8 4.6 L - Continued		
2010-2009: OE Type Radiator Cap .....	10253	21	2004-2003: OE Type Radiator Cap .....	10238	16
2010-2009: OE Equivalent Fuel Cap .....	10845		2004-2003: OE Equivalent Fuel Cap .....	10832	
2010-2009: Oil Filler Cap .....	10130		2004-2003: Regular Locking Fuel Cap .....	10502	
<b>SLK320</b>			2004-2003: Oil Filler Cap .....	10117	
V-6 3.2 L			2002-1996: OE Type Radiator Cap .....	10238	16
2004-2001: OE Type Radiator Cap .....	10253	21	2002-1996: OE Equivalent Fuel Cap .....	10832	
2004-2001: OE Equivalent Fuel Cap .....	10843		2002-1996: Regular Locking Fuel Cap .....	10502	
2004-2001: Oil Filler Cap .....	10130		2002-1996: Oil Filler Cap .....	10081	
<b>SLK350</b>			1995: OE Type Radiator Cap .....	10238	16
V-6 3.5 L			1995: Pre-Vent Non-Locking Fuel Cap .....	10819	
2010: OE Type Radiator Cap .....	10253	21	1995: Pre-Vent Locking Fuel Cap .....	10501	
2009: OE Type Radiator Cap .....	10253	21	1995: Oil Filler Cap .....	10081	
2009: OE Equivalent Fuel Cap .....	10845		<b>Marauder</b>		
2008-2005: OE Type Radiator Cap .....	10253	21	V-8 4.6 L		
2008-2005: OE Equivalent Fuel Cap .....	10845		2004-2003: OE Type Radiator Cap .....	10238	16
2008-2005: Oil Filler Cap .....	10130		2004-2003: OE Equivalent Fuel Cap .....	10832	
<b>SLR McLaren</b>			2004-2003: Regular Locking Fuel Cap .....	10502	
V-8 5.5 L			2004-2003: Oil Filler Cap .....	10081	
2009: OE Type Radiator Cap .....	10253	21	<b>Mariner</b>		
2009: OE Equivalent Fuel Cap .....	10845		4-Cyl. 2.3 L		
2008-2005: OE Type Radiator Cap .....	10253	21	2008-2007: OE Type Radiator Cap .....	10251	17
2008-2005: OE Equivalent Fuel Cap .....	10845		2008-2007: OE Equivalent Fuel Cap .....	10840	
2008-2005: Oil Filler Cap .....	10130		2008-2007: Regular Locking Fuel Cap .....	10510	
<b>Mercury</b>			2008-2007: Oil Filler Cap .....	10144	
<b>Cougar</b>			2006: OE Type Radiator Cap .....	10251	17
4-Cyl. 2.0 L			2006: OE Equivalent Fuel Cap .....	10840	
2002-2000: OE Type Radiator Cap .....	10251	17	2006: Regular Locking Fuel Cap .....	10510	
2002-2000: OE Equivalent Fuel Cap .....	10832		2006: Oil Filler Cap .....	10117	
2002-2000: Regular Locking Fuel Cap .....	10502		2005: OE Type Radiator Cap .....	10251	17
2002-2000: Oil Filler Cap .....	10101		2005: OE Equivalent Fuel Cap .....	10840	
1999: OE Type Radiator Cap .....	10251	17	2005: Regular Locking Fuel Cap .....	10510	
1999: OE Equivalent Fuel Cap .....	10832		4-Cyl. 2.3 L Electric Assist		
1999: Regular Locking Fuel Cap .....	10502		2008-2006: OE Type Radiator Cap .....	10251	17
1999: Oil Filler Cap .....	10081		2008-2006: OE Equivalent Fuel Cap .....	10840	
V-6 2.5 L			2008-2006: Regular Locking Fuel Cap .....	10510	
2002-2001: OE Type Radiator Cap .....	10251	17	2008-2006: Oil Filler Cap .....	10144	
2002-2001: OE Equivalent Fuel Cap .....	10832		4-Cyl. 2.5 L; 4-Cyl. 2.5 L Electric Assist		
2002-2001: Regular Locking Fuel Cap .....	10502		2010-2009: OE Type Radiator Cap .....	10251	17
2002-2001: Oil Filler Cap .....	10117		V-6 3.0 L		
2000-1999: OE Type Radiator Cap .....	10251	17	2011: Oil Filler Cap .....	10117	
2000-1999: OE Equivalent Fuel Cap .....	10832		2010: OE Type Radiator Cap .....	10251	17
2000-1999: Regular Locking Fuel Cap .....	10502		2010: Oil Filler Cap .....	10117	
2000-1999: Oil Filler Cap .....	10081		2009: OE Type Radiator Cap .....	10251	17
V-6 3.8 L			2008-2005: OE Type Radiator Cap .....	10251	17
1997-1995: Lev-R-Vent Radiator Cap .....	✓10333	16	2008-2005: OE Equivalent Fuel Cap .....	10840	
1997-1995: OE Type Radiator Cap .....	10233	16	2008-2005: Regular Locking Fuel Cap .....	10510	
1997-1995: Pre-Vent Non-Locking Fuel Cap .....	10819		2008-2005: Oil Filler Cap .....	10117	
1997-1995: Pre-Vent Locking Fuel Cap .....	10501		<b>Milan</b>		
1997-1995: Oil Filler Cap .....	10081		4-Cyl. 2.3 L		
V-8 4.6 L			2009-2008: OE Type Radiator Cap .....	10238	16
1997-1995: OE Type Radiator Cap .....	10238	16	2009-2008: OE Equivalent Fuel Cap .....	10840	
1997-1995: Pre-Vent Non-Locking Fuel Cap .....	10819		2009-2008: Regular Locking Fuel Cap .....	10510	
1997-1995: Pre-Vent Locking Fuel Cap .....	10501		2007-2006: OE Type Radiator Cap .....	10238	16
1997-1995: Oil Filler Cap .....	10081		2007-2006: OE Equivalent Fuel Cap .....	10840	
<b>Grand Marquis</b>			2007-2006: Regular Locking Fuel Cap .....	10510	
V-8 4.6 L			2007-2006: Oil Filler Cap .....	10144	
2011-2006: OE Type Radiator Cap .....	10238	16	4-Cyl. 2.5 L		
2011-2006: OE Equivalent Fuel Cap .....	10840		2011-2010: OE Type Radiator Cap .....	10238	16
2011-2006: Flex Fuel Regular Fuel Cap .....	10840Y		4-Cyl. 2.5 L Electric Assist		
2011-2006: Regular Locking Fuel Cap .....	10510		2010: OE Type Radiator Cap .....	10238	16
2011-2006: Flex Fuel Regular Locking Fuel Cap .....	10510Y		V-6 3.0 L		
2011-2006: Oil Filler Cap .....	10117		2011-2010: OE Type Radiator Cap .....	10238	16
2005: OE Type Radiator Cap .....	10238	16	2011-2010: Oil Filler Cap .....	10117	
2005: OE Equivalent Fuel Cap .....	10840		2009-2006: OE Type Radiator Cap .....	10238	16
2005: Regular Locking Fuel Cap .....	10510		2009-2006: OE Equivalent Fuel Cap .....	10840	
2005: Oil Filler Cap .....	10117		2009-2006: Regular Locking Fuel Cap .....	10510	
			2009-2006: Oil Filler Cap .....	10117	

✓ Check Hood Clearance prior to installing this Cap.

## Caps for Passenger Cars and Light Trucks (1990 and Newer)

Application	Part Number	PSI	Application	Part Number	PSI
<b>Mercury - Continued</b>			<b>Mercury - Continued</b>		
<b>Montego</b>			<b>Mountaineer - Continued</b>		
<b>V-6 3.0 L</b>			<b>V-8 4.6 L - Continued</b>		
2007-2005: OE Type Radiator Cap .....	10238	16	2004: Regular Locking Fuel Cap; For White Bottom O.E. Cap W/Orange O-Ring Seal .....	10510	
2007-2005: OE Equivalent Fuel Cap .....	10840		2004: Oil Filler Cap .....	10117	
2007-2005: Regular Locking Fuel Cap .....	10510		2003-2002: OE Type Radiator Cap .....	10238	16
2007-2005: Oil Filler Cap .....	10117		2003-2002: OE Equivalent Fuel Cap .....	10832	
<b>Monterey Van</b>			2003-2002: Regular Locking Fuel Cap .....	10502	
<b>V-6 4.2 L</b>			2003-2002: Oil Filler Cap .....	10081	
2007-2004: OE Type Radiator Cap .....	10238	16	<b>V-8 5.0 L</b>		
2007-2004: OE Equivalent Fuel Cap .....	10840		2001-1998: Lev-R-Vent Radiator Cap .....	✓10333	16
2007-2004: Regular Locking Fuel Cap .....	10510		2001-1998: OE Type Radiator Cap .....	10233	16
2007-2004: Oil Filler Cap .....	10081		2001-1998: OE Equivalent Fuel Cap .....	10832	
<b>Mountaineer</b>			2001-1998: Regular Locking Fuel Cap .....	10502	
<b>V-6 4.0 L</b>			2001-1998: Oil Filler Cap .....	10081	
2010-2009: OE Type Radiator Cap .....	10267	20	1997: Lev-R-Vent Radiator Cap .....	✓10333	16
2010-2009: Oil Filler Cap .....	10117		1997: OE Type Radiator Cap .....	10233	16
2008-2006: OE Type Radiator Cap .....	10267	20	1997: OE Equivalent Fuel Cap; Early .....	10833	
2008-2006: OE Equivalent Fuel Cap .....	10840		1997: Regular Locking Fuel Cap; Early .....	10503	
2008-2006: Regular Locking Fuel Cap .....	10510		1997: OE Equivalent Fuel Cap; Late .....	10832	
2008-2006: Oil Filler Cap .....	10117		1997: Regular Locking Fuel Cap; Late .....	10502	
2005: OE Type Radiator Cap .....	10238	16	1997: Oil Filler Cap .....	10081	
2005: OE Equivalent Fuel Cap .....	10840		<b>Mystique</b>		
2005: Flex Fuel Regular Fuel Cap .....	10840Y		<b>4-Cyl. 2.0 L</b>		
2005: Regular Locking Fuel Cap .....	10510		2000-1998: OE Type Radiator Cap .....	10251	17
2005: Flex Fuel Regular Locking Fuel Cap .....	10510Y		2000-1998: OE Equivalent Fuel Cap .....	10837	
2005: Oil Filler Cap .....	10117		2000-1998: Regular Locking Fuel Cap .....	10507	
2004: OE Type Radiator Cap .....	10238	16	2000-1998: Oil Filler Cap .....	10101	
2004: OE Equivalent Fuel Cap; For Black Bottom O.E. Cap .....	10832		1997-1995: OE Type Radiator Cap .....	10250	18
2004: Flex Fuel Regular Fuel Cap; For Black Bottom O.E. Cap ..	10832Y		1997-1995: Pre-Vent Non-Locking Fuel Cap .....	10819	
2004: Regular Locking Fuel Cap; For Black Bottom O.E. Cap .....	10502		1997-1995: Pre-Vent Locking Fuel Cap .....	10501	
2004: Flex Fuel Regular Locking Fuel Cap; For Black Bottom O.E. Cap .....	10502Y		1997-1995: Oil Filler Cap .....	10101	
2004: OE Equivalent Fuel Cap; For White Bottom O.E. Cap W/Orange O-Ring Seal .....	10840		<b>V-6 2.5 L</b>		
2004: Flex Fuel Regular Fuel Cap; For White Bottom O.E. Cap W/Orange O-Ring Seal .....	10840Y		2000-1998: OE Type Radiator Cap .....	10251	17
2004: Regular Locking Fuel Cap; For White Bottom O.E. Cap W/Orange O-Ring Seal .....	10510		2000-1998: OE Equivalent Fuel Cap .....	10837	
2004: Flex Fuel Regular Locking Fuel Cap; For White Bottom O.E. Cap W/Orange O-Ring Seal .....	10510Y		2000-1998: Regular Locking Fuel Cap .....	10507	
2004: Oil Filler Cap .....	10117		2000-1998: Oil Filler Cap .....	10081	
2003-2002: OE Type Radiator Cap .....	10238	16	1997-1995: OE Type Radiator Cap .....	10250	18
2003-2002: OE Equivalent Fuel Cap .....	10832		1997-1995: Pre-Vent Non-Locking Fuel Cap .....	10819	
2003-2002: Flex Fuel Regular Fuel Cap .....	10832Y		1997-1995: Pre-Vent Locking Fuel Cap .....	10501	
2003-2002: Regular Locking Fuel Cap .....	10502		1997-1995: Oil Filler Cap .....	10081	
2003-2002: Flex Fuel Regular Locking Fuel Cap .....	10502Y		<b>Sable</b>		
2003-2002: Oil Filler Cap .....	10117		<b>V-6 3.0 L</b>		
2001-1999: Lev-R-Vent Radiator Cap .....	✓10333	16	2005-2004: OE Type Radiator Cap .....	10238	16
2001-1999: OE Type Radiator Cap .....	10233	16	2005-2004: OE Equivalent Fuel Cap; For Black Bottom O.E. Cap .....	10832	
2001-1999: OE Equivalent Fuel Cap .....	10832		2005-2004: Regular Locking Fuel Cap; For Black Bottom O.E. Cap .....	10502	
2001-1999: Regular Locking Fuel Cap .....	10502		2005-2004: OE Equivalent Fuel Cap; For White Bottom O.E. Cap W/Orange O-Ring Seal .....	10840	
2001-1999: Oil Filler Cap .....	10101		2005-2004: Regular Locking Fuel Cap; For White Bottom O.E. Cap W/Orange O-Ring Seal .....	10510	
1998: Lev-R-Vent Radiator Cap .....	✓10333	16	2005-2004: Oil Filler Cap .....	10117	
1998: OE Type Radiator Cap .....	10233	16	2003-2001: OE Type Radiator Cap .....	10238	16
1998: OE Equivalent Fuel Cap .....	10832		2003-2001: OE Equivalent Fuel Cap .....	10832	
1998: Regular Locking Fuel Cap .....	10502		2003-2001: Regular Locking Fuel Cap .....	10502	
1998: Oil Filler Cap .....	10081		2003-2001: Oil Filler Cap .....	10117	
<b>V-8 4.6 L</b>			2000-1996: OE Type Radiator Cap .....	10238	16
2010-2009: OE Type Radiator Cap .....	10267	20	2000-1996: OE Equivalent Fuel Cap .....	10832	
2010-2009: Oil Filler Cap .....	10117		2000-1996: Regular Locking Fuel Cap .....	10502	
2008-2006: OE Type Radiator Cap .....	10267	20	2000-1996: Oil Filler Cap .....	10081	
2008-2006: OE Equivalent Fuel Cap .....	10840		1995: Lev-R-Vent Radiator Cap .....	10330	16
2008-2006: Regular Locking Fuel Cap .....	10510		1995: OE Type Radiator Cap .....	10230	16
2008-2006: Oil Filler Cap .....	10117		1995: Pre-Vent Non-Locking Fuel Cap .....	10819	
2005: OE Type Radiator Cap .....	10238	16	1995: Pre-Vent Locking Fuel Cap .....	10501	
2005: OE Equivalent Fuel Cap .....	10840		1995: Oil Filler Cap .....	10081	
2005: Regular Locking Fuel Cap .....	10510		<b>V-6 3.5 L</b>		
2005: Oil Filler Cap .....	10117		2009-2008: OE Type Radiator Cap .....	10238	16
2004: OE Type Radiator Cap .....	10238	16	2009-2008: OE Equivalent Fuel Cap .....	10840	
2004: OE Equivalent Fuel Cap; For Black Bottom O.E. Cap .....	10832		2009-2008: Regular Locking Fuel Cap .....	10510	
2004: Regular Locking Fuel Cap; For Black Bottom O.E. Cap .....	10502		2009-2008: Oil Filler Cap .....	10117	
2004: OE Equivalent Fuel Cap; For White Bottom O.E. Cap W/Orange O-Ring Seal .....	10840		<b>V-6 3.8 L</b>		
			1995: Lev-R-Vent Radiator Cap .....	10330	16

✓ Check Hood Clearance prior to installing this Cap.

## Caps for Passenger Cars and Light Trucks (1990 and Newer)

Application	Part Number	PSI	Application	Part Number	PSI
<b>Mercury - Continued</b>			<b>Mitsubishi - Continued</b>		
<b>Sable - Continued</b>			<b>3000GT - Continued</b>		
<b>V-6 3.8 L - Continued</b>			<b>V-6 3.0 L - Continued</b>		
1995; OE Type Radiator Cap .....	10230	16	1999-1998; OE Type Radiator Cap .....	10227	13
1995; Pre-Vent Non-Locking Fuel Cap .....	10819		1999-1998; OE Equivalent Fuel Cap .....	10834	
1995; Pre-Vent Locking Fuel Cap .....	10501		1999-1998; Regular Locking Fuel Cap .....	10504	
1995; Oil Filler Cap .....	10081		1999-1998; Oil Filler Cap .....	10088	
<b>Tracer</b>			1997-1995; Lev-R-Vent Radiator Cap .....		
<b>4-Cyl. 1.8 L</b>			✓10327 13		
1996-1995; Lev-R-Vent Radiator Cap .....	✓10327	13	1997-1995; OE Type Radiator Cap .....	10227	13
1996-1995; OE Type Radiator Cap .....	10227	13	1997-1995; OE Equivalent Fuel Cap .....	10817	
1996-1995; Pre-Vent Non-Locking Fuel Cap .....	10819		1997-1995; Pre-Vent Non-Locking Fuel Cap .....	10819	
1996-1995; Pre-Vent Locking Fuel Cap .....	10501		1997-1995; Regular Locking Fuel Cap .....	10591	
1996-1995; Oil Filler Cap .....	10082		1997-1995; Pre-Vent Locking Fuel Cap .....	10501	
<b>4-Cyl. 1.9 L</b>			1997-1995; Oil Filler Cap .....		
1996-1995; Lev-R-Vent Radiator Cap .....	✓10327	13	<b>Diamante</b>		
1996-1995; OE Type Radiator Cap .....	10227	13	<b>V-6 3.0 L</b>		
1996-1995; Pre-Vent Non-Locking Fuel Cap .....	10819		1996; OE Type Radiator Cap .....	10241	13
1996-1995; Pre-Vent Locking Fuel Cap .....	10501		1996; OE Equivalent Fuel Cap .....	10825	
1996-1995; Oil Filler Cap .....	10100		1996; Regular Locking Fuel Cap .....	10595	
<b>4-Cyl. 2.0 L</b>			1996; Oil Filler Cap .....		
1999-1998; Lev-R-Vent Radiator Cap .....	✓10333	16	1996; Oil Filler Cap .....	10088	
1999-1998; OE Type Radiator Cap .....	10233	16	1995; OE Type Radiator Cap: Sedan .....	10241	13
1999-1998; OE Equivalent Fuel Cap .....	10832		1995; Lev-R-Vent Radiator Cap: Wagon .....	✓10327	13
1999-1998; Regular Locking Fuel Cap .....	10502		1995; OE Type Radiator Cap: Wagon .....	10227	13
1999-1998; Oil Filler Cap .....	10081		1995; OE Equivalent Fuel Cap .....	10825	
1997; Lev-R-Vent Radiator Cap .....	✓10327	13	1995; Regular Locking Fuel Cap .....	10595	
1997; OE Type Radiator Cap .....	10227	13	1995; Oil Filler Cap .....	10088	
1997; Pre-Vent Non-Locking Fuel Cap .....	10819		<b>V-6 3.5 L</b>		
1997; Pre-Vent Locking Fuel Cap .....	10501		2004-1998; OE Type Radiator Cap .....	10241	13
1997; Oil Filler Cap .....	10081		2004-1998; OE Equivalent Fuel Cap .....	10834	
<b>Villager</b>			2004-1998; Regular Locking Fuel Cap .....		
<b>V-6 3.0 L</b>			2004-1998; Oil Filler Cap .....		
1998-1995; Lev-R-Vent Radiator Cap .....	✓10327	13	1997; OE Type Radiator Cap .....	10241	13
1998-1995; OE Type Radiator Cap .....	10227	13	1997; OE Equivalent Fuel Cap .....	10817	
1998-1995; Pre-Vent Non-Locking Fuel Cap .....	10819		1997; Pre-Vent Non-Locking Fuel Cap .....	10819	
1998-1995; Pre-Vent Locking Fuel Cap .....	10501		1997; Regular Locking Fuel Cap .....	10591	
1998-1995; Oil Filler Cap .....	10107		1997; Pre-Vent Locking Fuel Cap .....	10501	
<b>V-6 3.3 L</b>			1997; Oil Filler Cap .....		
2002-2000; Lev-R-Vent Radiator Cap .....	✓10327	13	<b>Eclipse</b>		
2002-2000; OE Type Radiator Cap .....	10227	13	<b>4-Cyl. 2.0 L</b>		
2002-2000; OE Equivalent Fuel Cap .....	10838		1999; Lev-R-Vent Radiator Cap .....	✓10327	13
2002-2000; Regular Locking Fuel Cap .....	10508		1999; OE Type Radiator Cap .....	10227	13
2002-2000; Oil Filler Cap .....	10107		1999; OE Equivalent Fuel Cap .....	10834	
1999; Lev-R-Vent Radiator Cap .....	✓10327	13	1999; Regular Locking Fuel Cap .....	10504	
1999; OE Type Radiator Cap .....	10227	13	1999; Oil Filler Cap .....	10111	
1999; Pre-Vent Non-Locking Fuel Cap .....	10819		1998; Lev-R-Vent Radiator Cap: W/Turbo .....	✓10327	13
1999; Pre-Vent Locking Fuel Cap .....	10501		1998; OE Type Radiator Cap: W/Turbo .....	10227	13
1999; Oil Filler Cap .....	10107		1998; Lev-R-Vent Radiator Cap: W/O Turbo .....	✓10333	16
<b>Mini</b>			1998; OE Type Radiator Cap: W/O Turbo .....		
<b>Cooper</b>			1998; OE Equivalent Fuel Cap .....		
<b>4-Cyl. 1.6 L</b>			1998; Regular Locking Fuel Cap .....		
2011-2009; OE Equivalent Fuel Cap .....	10844		1998; Oil Filler Cap: W/Turbo .....	10088	
2008-2007; Lev-R-Vent Radiator Cap .....	10330	16	1998; Oil Filler Cap: W/O Turbo .....	10111	
2008-2007; OE Type Radiator Cap .....	10230	16	1997-1995; Lev-R-Vent Radiator Cap: W/Turbo .....	✓10327	13
2008-2007; OE Equivalent Fuel Cap .....	10844		1997-1995; OE Type Radiator Cap: W/Turbo .....	10227	13
2008-2007; Oil Filler Cap .....	10111		1997-1995; Lev-R-Vent Radiator Cap: W/O Turbo .....	✓10333	16
2006; Lev-R-Vent Radiator Cap: W/O Supercharger .....	10330	16	1997-1995; OE Type Radiator Cap .....	10817	
2006; OE Type Radiator Cap: W/O Supercharger .....	10230	16	1997-1995; Pre-Vent Non-Locking Fuel Cap .....	10819	
2006; OE Equivalent Fuel Cap .....	10844		1997-1995; Regular Locking Fuel Cap .....	10591	
2006; Oil Filler Cap .....	10111		1997-1995; Pre-Vent Locking Fuel Cap .....	10501	
2005-2002; Lev-R-Vent Radiator Cap .....	10330	16	1997-1995; Oil Filler Cap: W/Turbo .....	10088	
2005-2002; OE Type Radiator Cap .....	10230	16	1997-1995; Oil Filler Cap: W/O Turbo .....	10111	
2005-2002; OE Equivalent Fuel Cap .....	10844		<b>4-Cyl. 2.4 L</b>		
2005-2002; Oil Filler Cap .....	10111		2011; OE Type Radiator Cap .....	10242	16
<b>Mitsubishi</b>			2010; OE Type Radiator Cap .....		
<b>3000GT</b>			2010; OE Equivalent Fuel Cap .....		
<b>V-6 3.0 L</b>			2010; Regular Locking Fuel Cap .....		
1999-1998; Lev-R-Vent Radiator Cap .....	✓10327	13	2009-2001; OE Type Radiator Cap .....	10242	16
			2009-2001; OE Equivalent Fuel Cap .....	10838	
			2009-2001; Regular Locking Fuel Cap .....	10508	
			2009-2001; Oil Filler Cap .....	10088	
			2000; OE Type Radiator Cap .....	10241	13
			2000; OE Equivalent Fuel Cap .....	10834	

✓ Check Hood Clearance prior to installing this Cap.

## Caps for Passenger Cars and Light Trucks (1990 and Newer)

Application	Part Number	PSI	Application	Part Number	PSI
<b>Mitsubishi - Continued</b>			<b>Mitsubishi - Continued</b>		
<b>Eclipse - Continued</b>			<b>Galant - Continued</b>		
<b>4-Cyl. 2.4 L - Continued</b>			<b>4-Cyl. 2.4 L - Continued</b>		
2000; Regular Locking Fuel Cap .....	10504		1997-1995; Regular Locking Fuel Cap .....	10591	
2000; Oil Filler Cap .....	10088		1997-1995; Pre-Vent Locking Fuel Cap .....	10501	
1999-1998; Lev-R-Vent Radiator Cap .....	✓10327	13	1997-1995; Oil Filler Cap .....	10088	
1999-1998; OE Type Radiator Cap .....	10227	13	<b>V-6 3.0 L</b>		
1999-1998; OE Equivalent Fuel Cap .....	10834		2003-2001; OE Type Radiator Cap .....	10242	16
1999-1998; Regular Locking Fuel Cap .....	10504		2003-2001; OE Equivalent Fuel Cap .....	10838	
1999-1998; Oil Filler Cap .....	10088		2003-2001; Regular Locking Fuel Cap .....	10508	
1997-1996; Lev-R-Vent Radiator Cap .....	✓10327	13	2003-2001; Oil Filler Cap .....	10088	
1997-1996; OE Type Radiator Cap .....	10227	13	2000-1999; OE Type Radiator Cap .....	10241	13
1997-1996; OE Equivalent Fuel Cap .....	10817		2000-1999; OE Equivalent Fuel Cap .....	10834	
1997-1996; Pre-Vent Non-Locking Fuel Cap .....	10819		2000-1999; Regular Locking Fuel Cap .....	10504	
1997-1996; Regular Locking Fuel Cap .....	10591		2000-1999; Oil Filler Cap .....	10088	
1997-1996; Pre-Vent Locking Fuel Cap .....	10501		<b>V-6 3.8 L</b>		
1997-1996; Oil Filler Cap .....	10088		2009-2004; OE Type Radiator Cap .....	10242	16
<b>V-6 3.0 L</b>			2009-2004; OE Equivalent Fuel Cap .....	10838	
2005-2002; OE Type Radiator Cap .....	10242	16	2009-2004; Regular Locking Fuel Cap .....	10508	
2005-2002; OE Equivalent Fuel Cap .....	10838		2009-2004; Oil Filler Cap .....	10088	
2005-2002; Regular Locking Fuel Cap .....	10508		<b>Lancer</b>		
2005-2002; Oil Filler Cap .....	10088		<b>4-Cyl. 2.0 L</b>		
2001; OE Type Radiator Cap .....	10241	13	2011; OE Type Radiator Cap .....	10233	16
2001; OE Equivalent Fuel Cap .....	10838		2011; Lev-R-Vent Radiator Cap .....	10333	16
2001; Regular Locking Fuel Cap .....	10508		2010; Lev-R-Vent Radiator Cap .....	10333	16
2001; Oil Filler Cap .....	10088		2010; OE Type Radiator Cap .....	10233	16
2000; OE Type Radiator Cap .....	10241	13	2010; OE Equivalent Fuel Cap .....	10834	
2000; OE Equivalent Fuel Cap .....	10834		2010; Regular Locking Fuel Cap .....	10504	
2000; Regular Locking Fuel Cap .....	10504		2009; Lev-R-Vent Radiator Cap .....	✓10333	16
2000; Oil Filler Cap .....	10088		2009; OE Type Radiator Cap .....	10233	16
<b>V-6 3.8 L</b>			2009; OE Equivalent Fuel Cap .....	10834	
2011; OE Type Radiator Cap .....	10242	16	2009; Regular Locking Fuel Cap .....	10504	
2010; OE Type Radiator Cap .....	10242	16	2009; Oil Filler Cap; W/O Turbo .....	10111	
2010; OE Equivalent Fuel Cap .....	10838		2008-2002; Lev-R-Vent Radiator Cap .....	✓10333	16
2010; Regular Locking Fuel Cap .....	10508		2008-2002; OE Type Radiator Cap .....	10233	16
2009-2006; OE Type Radiator Cap .....	10242	16	2008-2002; OE Equivalent Fuel Cap .....	10834	
2009-2006; OE Equivalent Fuel Cap .....	10838		2008-2002; Regular Locking Fuel Cap .....	10504	
2009-2006; Regular Locking Fuel Cap .....	10508		2008-2002; Oil Filler Cap .....	10088	
2009-2006; Oil Filler Cap .....	10088		<b>4-Cyl. 2.4 L</b>		
<b>Endeavor</b>			2011; OE Type Radiator Cap .....	10233	16
<b>V-6 3.8 L</b>			2011; Lev-R-Vent Radiator Cap .....	10333	16
2011; OE Type Radiator Cap .....	10242	16	2010; Lev-R-Vent Radiator Cap .....	10333	16
2010; OE Type Radiator Cap .....	10242	16	2010; OE Type Radiator Cap .....	10233	16
2010; OE Equivalent Fuel Cap .....	10838		2010; OE Equivalent Fuel Cap .....	10834	
2010; Regular Locking Fuel Cap .....	10508		2010; Regular Locking Fuel Cap .....	10504	
2008-2004; OE Type Radiator Cap .....	10242	16	2009; Lev-R-Vent Radiator Cap .....	✓10333	16
2008-2004; OE Equivalent Fuel Cap .....	10838		2009; OE Type Radiator Cap .....	10233	16
2008-2004; Regular Locking Fuel Cap .....	10508		2009; OE Equivalent Fuel Cap .....	10834	
2008-2004; Oil Filler Cap .....	10088		2009; Regular Locking Fuel Cap .....	10504	
<b>Expo</b>			2009; Oil Filler Cap .....	10111	
<b>4-Cyl. 2.4 L</b>			2006-2004; Lev-R-Vent Radiator Cap .....	✓10333	16
1995; OE Type Radiator Cap .....	10241	13	2006-2004; OE Type Radiator Cap .....	10233	16
1995; OE Equivalent Fuel Cap .....	10825		2006-2004; OE Equivalent Fuel Cap .....	10834	
1995; Regular Locking Fuel Cap .....	10595		2006-2004; Regular Locking Fuel Cap .....	10504	
1995; Oil Filler Cap .....	10088		2006-2004; Oil Filler Cap .....	10088	
<b>Galant</b>			<b>Mirage</b>		
<b>4-Cyl. 2.4 L</b>			<b>4-Cyl. 1.5 L; 4-Cyl. 1.8 L</b>		
2011; OE Type Radiator Cap .....	10242	16	2002-1998; OE Type Radiator Cap .....	10241	13
2010; OE Type Radiator Cap .....	10242	16	2002-1998; OE Equivalent Fuel Cap .....	10834	
2010; OE Equivalent Fuel Cap .....	10838		2002-1998; Regular Locking Fuel Cap .....	10504	
2010; Regular Locking Fuel Cap .....	10508		2002-1998; Oil Filler Cap .....	10088	
2009-2001; OE Type Radiator Cap .....	10242	16	1997-1995; OE Type Radiator Cap .....	10241	13
2009-2001; OE Equivalent Fuel Cap .....	10838		1997-1995; OE Equivalent Fuel Cap .....	10825	
2009-2001; Regular Locking Fuel Cap .....	10508		1997-1995; Regular Locking Fuel Cap .....	10595	
2009-2001; Oil Filler Cap .....	10088		1997-1995; Oil Filler Cap .....	10088	
2000-1998; OE Type Radiator Cap .....	10241	13	<b>Montero</b>		
2000-1998; OE Equivalent Fuel Cap .....	10834		<b>V-6 3.0 L</b>		
2000-1998; Regular Locking Fuel Cap .....	10504		1996-1995; Lev-R-Vent Radiator Cap .....	✓10327	13
2000-1998; Oil Filler Cap .....	10088		1996-1995; OE Type Radiator Cap .....	10227	13
1997-1995; OE Type Radiator Cap .....	10241	13	1996-1995; OE Equivalent Fuel Cap .....	10825	
1997-1995; OE Equivalent Fuel Cap .....	10817		1996-1995; Regular Locking Fuel Cap .....	10595	
1997-1995; Pre-Vent Non-Locking Fuel Cap .....	10819		1996-1995; Oil Filler Cap .....	10088	

✓ Check Hood Clearance prior to installing this Cap.

## Caps for Passenger Cars and Light Trucks (1990 and Newer)

Application	Part Number	PSI	Application	Part Number	PSI
<b>Mitsubishi - Continued</b>			<b>Mitsubishi - Continued</b>		
<b>Montero - Continued</b>			<b>Outlander - Continued</b>		
<b>V-6 3.5 L</b>			<b>4-Cyl. 2.4 L - Continued</b>		
2002-2001; Lev-R-Vent Radiator Cap .....	✓10327	13	2009; OE Type Radiator Cap .....	10233	16
2002-2001; OE Type Radiator Cap .....	10227	13	2009; OE Equivalent Fuel Cap .....	10834	
2002-2001; OE Equivalent Fuel Cap .....	10834		2009; Regular Locking Fuel Cap .....	10504	
2002-2001; Regular Locking Fuel Cap .....	10504		2009; Oil Filler Cap .....	10111	
2002-2001; Oil Filler Cap .....	10088		2008; Lev-R-Vent Radiator Cap .....	✓10333	16
2000; OE Type Radiator Cap .....	10241	13	2008; OE Type Radiator Cap .....	10233	16
2000; OE Equivalent Fuel Cap .....	10834		2008; OE Equivalent Fuel Cap .....	10834	
2000; Regular Locking Fuel Cap .....	10504		2008; Regular Locking Fuel Cap .....	10504	
2000; Oil Filler Cap .....	10088		2008; Oil Filler Cap .....	10088	
1999-1998; Lev-R-Vent Radiator Cap .....	✓10327	13	2006-2003; Lev-R-Vent Radiator Cap .....	✓10333	16
1999-1998; OE Type Radiator Cap .....	10227	13	2006-2003; OE Type Radiator Cap .....	10233	16
1999-1998; OE Equivalent Fuel Cap .....	10834		2006-2003; OE Equivalent Fuel Cap .....	10834	
1999-1998; Regular Locking Fuel Cap .....	10504		2006-2003; Regular Locking Fuel Cap .....	10504	
1999-1998; Oil Filler Cap .....	10088		2006-2003; Oil Filler Cap .....	10088	
1997; Lev-R-Vent Radiator Cap .....	✓10327	13	<b>V-6 3.0 L</b>		
1997; OE Type Radiator Cap .....	10227	13	2011; OE Type Radiator Cap .....	10233	16
1997; OE Equivalent Fuel Cap .....	10825		2011; Lev-R-Vent Radiator Cap .....	10333	16
1997; Regular Locking Fuel Cap .....	10595		2010; Lev-R-Vent Radiator Cap .....	10333	16
1997; Oil Filler Cap .....	10088		2010; OE Type Radiator Cap .....	10233	16
1996-1995; Lev-R-Vent Radiator Cap .....	✓10327	13	2009-2007; Lev-R-Vent Radiator Cap .....	✓10333	16
1996-1995; OE Type Radiator Cap .....	10227	13	2009-2007; OE Type Radiator Cap .....	10233	16
1996-1995; OE Equivalent Fuel Cap .....	10825		2009-2007; OE Equivalent Fuel Cap .....	10834	
1996-1995; Regular Locking Fuel Cap .....	10595		2009-2007; Regular Locking Fuel Cap .....	10504	
1996-1995; Oil Filler Cap .....	10083		2009-2007; Oil Filler Cap .....	10111	
<b>V-6 3.8 L</b>			<b>Pickup</b>		
2006-2003; Lev-R-Vent Radiator Cap .....	✓10333	16	<b>4-Cyl. 2.4 L</b>		
2006-2003; OE Type Radiator Cap .....	10233	16	1996-1995; Lev-R-Vent Radiator Cap .....	✓10327	13
2006-2003; OE Equivalent Fuel Cap .....	10834		1996-1995; OE Type Radiator Cap .....	10227	13
2006-2003; Regular Locking Fuel Cap .....	10504		1996-1995; OE Equivalent Fuel Cap .....	10825	
2006-2003; Oil Filler Cap .....	10088		1996-1995; Regular Locking Fuel Cap .....	10595	
<b>Montero Sport</b>			1996-1995; Oil Filler Cap .....	10088	
<b>4-Cyl. 2.4 L</b>			<b>Raider</b>		
1999-1997; OE Type Radiator Cap .....	10241	13	<b>V-6 3.7 L</b>		
1999-1997; OE Equivalent Fuel Cap .....	10834		2009; OE Equivalent Fuel Cap .....	10838	
1999-1997; Regular Locking Fuel Cap .....	10504		2009; Regular Locking Fuel Cap .....	10508	
1999-1997; Oil Filler Cap .....	10088		2009; Oil Filler Cap .....	10120	
<b>V-6 3.0 L</b>			2008-2006; Lev-R-Vent Radiator Cap .....	10330	16
2003; OE Type Radiator Cap; Dec. 2 & Older .....	10241	13	2008-2006; OE Type Radiator Cap .....	10230	16
2003; OE Type Radiator Cap; Dec. 3 & Newer .....	10242	16	2008-2006; OE Equivalent Fuel Cap .....	10838	
2003; OE Equivalent Fuel Cap .....	10834		2008-2006; Regular Locking Fuel Cap .....	10508	
2003; Regular Locking Fuel Cap .....	10504		2008-2006; Oil Filler Cap .....	10120	
2003; Oil Filler Cap .....	10088		<b>V-8 4.7 L</b>		
2002-1997; OE Type Radiator Cap .....	10241	13	2007-2006; Lev-R-Vent Radiator Cap .....	10330	16
2002-1997; OE Equivalent Fuel Cap .....	10834		2007-2006; OE Type Radiator Cap .....	10230	16
2002-1997; Regular Locking Fuel Cap .....	10504		2007-2006; OE Equivalent Fuel Cap .....	10838	
2002-1997; Oil Filler Cap .....	10088		2007-2006; Regular Locking Fuel Cap .....	10508	
<b>V-6 3.5 L</b>			2007-2006; Oil Filler Cap .....	10120	
2004; OE Type Radiator Cap .....	10242	16	<b>Nissan</b>		
2004; OE Equivalent Fuel Cap .....	10834		<b>200SX</b>		
2004; Regular Locking Fuel Cap .....	10504		<b>4-Cyl. 1.6 L; 4-Cyl. 2.0 L</b>		
2004; Oil Filler Cap .....	10088		1998-1995; Lev-R-Vent Radiator Cap .....	✓10327	13
2003; OE Type Radiator Cap; Dec. 2 & Older .....	10241	13	1998-1995; OE Type Radiator Cap .....	10227	13
2003; OE Type Radiator Cap; Dec. 3 & Newer .....	10242	16	1998-1995; OE Equivalent Fuel Cap .....	10817	
2003; OE Equivalent Fuel Cap .....	10834		1998-1995; Pre-Vent Non-Locking Fuel Cap .....	10819	
2003; Regular Locking Fuel Cap .....	10504		1998-1995; Regular Locking Fuel Cap .....	10591	
2003; Oil Filler Cap .....	10088		1998-1995; Pre-Vent Locking Fuel Cap .....	10501	
2002-1999; OE Type Radiator Cap .....	10241	13	1998-1995; Oil Filler Cap .....	10107	
2002-1999; OE Equivalent Fuel Cap .....	10834		<b>240SX</b>		
2002-1999; Regular Locking Fuel Cap .....	10504		<b>4-Cyl. 2.4 L</b>		
2002-1999; Oil Filler Cap .....	10088		1998-1995; Lev-R-Vent Radiator Cap .....	✓10327	13
<b>Outlander</b>			1998-1995; OE Type Radiator Cap .....	10227	13
<b>4-Cyl. 2.0 L</b>			1998-1995; OE Equivalent Fuel Cap .....	10817	
2011; OE Type Radiator Cap .....	10233	16	1998-1995; Pre-Vent Non-Locking Fuel Cap .....	10819	
2011; Lev-R-Vent Radiator Cap .....	10333	16	1998-1995; Regular Locking Fuel Cap .....	10591	
<b>4-Cyl. 2.4 L</b>			1998-1995; Pre-Vent Locking Fuel Cap .....	10501	
2011; OE Type Radiator Cap .....	10233	16	1998-1995; Oil Filler Cap .....	10107	
2011; Lev-R-Vent Radiator Cap .....	10333	16			
2010; Lev-R-Vent Radiator Cap .....	10333	16			
2010; OE Type Radiator Cap .....	10233	16			
2009; Lev-R-Vent Radiator Cap .....	✓10333	16			

✓ Check Hood Clearance prior to installing this Cap.

## Caps for Passenger Cars and Light Trucks (1990 and Newer)

Application	Part Number	PSI	Application	Part Number	PSI
<b>Nissan - Continued</b>			<b>Nissan - Continued</b>		
<b>300ZX</b>			<b>Altima - Continued</b>		
<b>V-6 3.0 L</b>			<b>4-Cyl. 2.5 L Electric Assist - Continued</b>		
1996-1995; Lev-R-Vent Radiator Cap .....	✓10333	16	2010; OE Equivalent Fuel Cap .....	10838	
1996-1995; OE Type Radiator Cap .....	10233	16	2010; Regular Locking Fuel Cap .....	10508	
1996-1995; OE Equivalent Fuel Cap .....	10817		2009-2007; OE Type Radiator Cap .....	10267	20
1996-1995; Pre-Vent Non-Locking Fuel Cap .....	10819		2009-2007; OE Equivalent Fuel Cap .....	10838	
1996-1995; Regular Locking Fuel Cap .....	10591		2009-2007; Regular Locking Fuel Cap .....	10508	
1996-1995; Pre-Vent Locking Fuel Cap .....	10501		2009-2007; Oil Filler Cap .....	10107	
1996-1995; Oil Filler Cap .....	10107				
<b>350Z</b>			<b>V-6 3.5 L</b>		
<b>V-6 3.5 L</b>			2012-2011; OE Equivalent Fuel Cap .....		
2009; Lev-R-Vent Radiator Cap .....	✓10333	16	2012-2011; Regular Locking Fuel Cap .....	10508	
2009; OE Type Radiator Cap .....	10233	16	2010; OE Type Radiator Cap .....	10267	20
2009; OE Equivalent Fuel Cap .....	10838		2010; OE Equivalent Fuel Cap .....	10838	
2009; Regular Locking Fuel Cap .....	10508		2010; Regular Locking Fuel Cap .....	10508	
2009; Oil Filler Cap .....	10107		2009-2007; OE Type Radiator Cap .....	10267	20
2008; Lev-R-Vent Radiator Cap .....	✓10333	16	2009-2007; OE Equivalent Fuel Cap .....	10838	
2008; OE Type Radiator Cap .....	10233	16	2009-2007; Regular Locking Fuel Cap .....	10508	
2008; Oil Filler Cap .....	10107		2009-2007; Oil Filler Cap .....	10107	
2007; Lev-R-Vent Radiator Cap .....	✓10333	16	2006-2002; Lev-R-Vent Radiator Cap .....	✓10327	13
2007; OE Type Radiator Cap .....	10233	16	2006-2002; OE Type Radiator Cap .....	10227	13
2007; OE Equivalent Fuel Cap .....	10838		2006-2002; OE Equivalent Fuel Cap .....	10838	
2007; Regular Locking Fuel Cap .....	10508		2006-2002; Regular Locking Fuel Cap .....	10508	
2007; Oil Filler Cap .....	10107		2006-2002; Oil Filler Cap .....	10107	
2006-2003; Lev-R-Vent Radiator Cap .....	✓10327	13			
2006-2003; OE Type Radiator Cap .....	10227	13	<b>Armada</b>		
2006-2003; OE Equivalent Fuel Cap .....	10838		<b>V-8 5.6 L</b>		
2006-2003; Regular Locking Fuel Cap .....	10508		2011; OE Equivalent Fuel Cap .....		
2006-2003; Oil Filler Cap .....	10107		2011; Regular Locking Fuel Cap .....		
			2011; Flex Fuel Regular Fuel Cap .....		
			2011; Flex Fuel Regular Locking Fuel Cap .....		
			2010; OE Equivalent Fuel Cap .....		
			2010; Regular Locking Fuel Cap .....		
			2009; OE Type Radiator Cap: Early .....		
			2009; Coolant Recovery Tank Cap .....		
			2009; OE Equivalent Fuel Cap .....		
			2009; Regular Locking Fuel Cap .....		
			2009; Flex Fuel Regular Fuel Cap .....		
			2009; Flex Fuel Regular Locking Fuel Cap .....		
			2009; Oil Filler Cap .....		
			2008-2007; OE Type Radiator Cap .....		
			2008-2007; Coolant Recovery Tank Cap .....		
			2008-2007; OE Equivalent Fuel Cap .....		
			2008-2007; Flex Fuel Regular Fuel Cap .....		
			2008-2007; Regular Locking Fuel Cap .....		
			2008-2007; Flex Fuel Regular Locking Fuel Cap .....		
			2008-2007; Oil Filler Cap .....		
			2006-2005; OE Type Radiator Cap .....		
			2006-2005; Coolant Recovery Tank Cap .....		
			2006-2005; OE Equivalent Fuel Cap .....		
			2006-2005; Regular Locking Fuel Cap .....		
			2006-2005; Oil Filler Cap .....		
			<b>Cube</b>		
			<b>4-Cyl. 1.8 L</b>		
			2011; OE Equivalent Fuel Cap .....		
			2011; Regular Locking Fuel Cap .....		
			2010-2009; Lev-R-Vent Radiator Cap .....		
			2010-2009; OE Type Radiator Cap .....		
			2010-2009; OE Equivalent Fuel Cap .....		
			2010-2009; Regular Locking Fuel Cap .....		
			2010-2009; Oil Filler Cap .....		
			<b>Frontier</b>		
			<b>4-Cyl. 2.4 L</b>		
			2004-2001; Lev-R-Vent Radiator Cap .....		
			2004-2001; OE Type Radiator Cap .....		
			2004-2001; OE Equivalent Fuel Cap .....		
			2004-2001; Regular Locking Fuel Cap .....		
			2004-2001; Oil Filler Cap .....		
			2000-1998; Lev-R-Vent Radiator Cap .....		
			2000-1998; OE Type Radiator Cap .....		
			2000-1998; OE Equivalent Fuel Cap .....		
			2000-1998; Pre-Vent Non-Locking Fuel Cap .....		
			2000-1998; Regular Locking Fuel Cap .....		
			2000-1998; Pre-Vent Locking Fuel Cap .....		

✓ Check Hood Clearance prior to installing this Cap.

## Caps for Passenger Cars and Light Trucks (1990 and Newer)

Application	Part Number	PSI	Application	Part Number	PSI
<b>Nissan - Continued</b>			<b>Nissan - Continued</b>		
<b>Frontier - Continued</b>			<b>Maxima - Continued</b>		
<b>4-Cyl. 2.4 L - Continued</b>			<b>V-6 3.0 L - Continued</b>		
2000-1998; Oil Filler Cap .....	10107		2000-1995; Lev-R-Vent Radiator Cap .....	✓10327	13
<b>4-Cyl. 2.5 L</b>			2000-1995; OE Type Radiator Cap .....	10227	13
2011; OE Equivalent Fuel Cap .....	10838		2000-1995; OE Equivalent Fuel Cap .....	10817	
2011; Regular Locking Fuel Cap .....	10508		2000-1995; Pre-Vent Non-Locking Fuel Cap .....	10819	
2010; Lev-R-Vent Radiator Cap .....	10333	16	2000-1995; Regular Locking Fuel Cap .....	10591	
2010; OE Type Radiator Cap .....	10233	16	2000-1995; Pre-Vent Locking Fuel Cap .....	10501	
2010; OE Equivalent Fuel Cap .....	10838		2000-1995; Oil Filler Cap .....	10107	
2010; Regular Locking Fuel Cap .....	10508		<b>V-6 3.5 L</b>		
2009; Lev-R-Vent Radiator Cap .....	10333	16	2011-2010; OE Type Radiator Cap .....	10267	20
2009; OE Type Radiator Cap .....	10233	16	2011-2010; OE Equivalent Fuel Cap .....	10838	
2009; OE Equivalent Fuel Cap .....	10838		2011-2010; Regular Locking Fuel Cap .....	10508	
2009; Regular Locking Fuel Cap .....	10508		2009; OE Type Radiator Cap .....	10267	20
2009; Oil Filler Cap .....	10107		2009; OE Equivalent Fuel Cap .....	10838	
2008-2005; Lev-R-Vent Radiator Cap .....	✓10333	16	2009; Regular Locking Fuel Cap .....	10508	
2008-2005; OE Type Radiator Cap .....	10233	16	2009; Oil Filler Cap .....	10107	
2008-2005; OE Equivalent Fuel Cap .....	10838		2008-2002; Lev-R-Vent Radiator Cap .....	✓10327	13
2008-2005; Regular Locking Fuel Cap .....	10508		2008-2002; OE Type Radiator Cap .....	10227	13
2008-2005; Oil Filler Cap .....	10107		2008-2002; OE Equivalent Fuel Cap .....	10838	
<b>V-6 3.3 L</b>			2008-2002; Regular Locking Fuel Cap .....	10508	
2004-2001; Lev-R-Vent Radiator Cap .....	✓10327	13	2008-2002; Oil Filler Cap .....	10107	
2004-2001; OE Type Radiator Cap .....	10227	13	<b>Murano</b>		
2004-2001; OE Equivalent Fuel Cap .....	10838		<b>V-6 3.5 L</b>		
2004-2001; Regular Locking Fuel Cap .....	10508		2011; OE Equivalent Fuel Cap .....	10838	
2004-2001; Oil Filler Cap .....	10107		2011; Regular Locking Fuel Cap .....	10508	
2000-1999; Lev-R-Vent Radiator Cap .....	✓10327	13	2010; OE Type Radiator Cap .....	10267	20
2000-1999; OE Type Radiator Cap .....	10227	13	2010; Oil Filler Cap .....	10107	
2000-1999; OE Equivalent Fuel Cap .....	10817		2009; OE Type Radiator Cap .....	10267	20
2000-1999; Pre-Vent Non-Locking Fuel Cap .....	10819		2009; OE Equivalent Fuel Cap .....	10838	
2000-1999; Regular Locking Fuel Cap .....	10591		2009; Regular Locking Fuel Cap .....	10508	
2000-1999; Pre-Vent Locking Fuel Cap .....	10501		2009; Oil Filler Cap .....	10107	
2000-1999; Oil Filler Cap .....	10107		2007-2003; Lev-R-Vent Radiator Cap .....	✓10327	13
<b>V-6 4.0 L</b>			2007-2003; OE Type Radiator Cap .....	10227	13
2011-2010; Lev-R-Vent Radiator Cap .....	10333	16	2007-2003; OE Equivalent Fuel Cap .....	10838	
2011-2010; OE Type Radiator Cap .....	10233	16	2007-2003; Regular Locking Fuel Cap .....	10508	
2011-2010; OE Equivalent Fuel Cap .....	10838		2007-2003; Oil Filler Cap .....	10107	
2011-2010; Regular Locking Fuel Cap .....	10508		<b>Pathfinder</b>		
2009; Lev-R-Vent Radiator Cap .....	10333	16	<b>V-6 3.0 L</b>		
2009; OE Type Radiator Cap .....	10233	16	1995; Lev-R-Vent Radiator Cap .....	✓10327	13
2009; OE Equivalent Fuel Cap .....	10838		1995; OE Type Radiator Cap .....	10227	13
2009; Regular Locking Fuel Cap .....	10508		1995; OE Equivalent Fuel Cap .....	10817	
2009; Oil Filler Cap .....	10107		1995; Pre-Vent Non-Locking Fuel Cap .....	10819	
2008-2005; Lev-R-Vent Radiator Cap .....	✓10333	16	1995; Regular Locking Fuel Cap .....	10591	
2008-2005; OE Type Radiator Cap .....	10233	16	1995; Pre-Vent Locking Fuel Cap .....	10501	
2008-2005; OE Equivalent Fuel Cap .....	10838		1995; Oil Filler Cap .....	10107	
2008-2005; Regular Locking Fuel Cap .....	10508		<b>V-6 3.3 L</b>		
2008-2005; Oil Filler Cap .....	10107		2000-1996; Lev-R-Vent Radiator Cap .....	✓10327	13
<b>GT-R</b>			2000-1996; OE Type Radiator Cap .....	10227	13
<b>V-6 3.8 L</b>			2000-1996; OE Equivalent Fuel Cap .....	10817	
2012; Coolant Recovery Tank Cap .....	10267		2000-1996; Pre-Vent Non-Locking Fuel Cap .....	10819	
2012; OE Type Radiator Cap .....	10264		2000-1996; Regular Locking Fuel Cap .....	10591	
2011-2010; OE Type Radiator Cap .....	10267	20	2000-1996; Pre-Vent Locking Fuel Cap .....	10501	
2011-2010; OE Type Radiator Cap .....	10264		2000-1996; Oil Filler Cap .....	10107	
2011-2010; OE Equivalent Fuel Cap .....	10834		<b>V-6 3.5 L</b>		
2011-2010; Regular Locking Fuel Cap .....	10504		2004-2002; Lev-R-Vent Radiator Cap .....	✓10327	13
2009; OE Type Radiator Cap .....	10267	20	2004-2002; OE Type Radiator Cap .....	10227	13
2009; OE Type Radiator Cap .....	10264		2004-2002; OE Equivalent Fuel Cap .....	10838	
2009; OE Equivalent Fuel Cap .....	10838		2004-2002; Regular Locking Fuel Cap .....	10508	
2009; Regular Locking Fuel Cap .....	10508		2004-2002; Oil Filler Cap .....	10107	
<b>Juke</b>			2001; Lev-R-Vent Radiator Cap .....	✓10327	13
<b>4-Cyl. 1.6 L</b>			2001; OE Type Radiator Cap .....	10227	13
2011; OE Equivalent Fuel Cap .....	10838		2001; OE Equivalent Fuel Cap .....	10834	
2011; Regular Locking Fuel Cap .....	10508		2001; Regular Locking Fuel Cap .....	10504	
<b>Maxima</b>			2001; Oil Filler Cap .....	10107	
<b>V-6 3.0 L</b>			<b>V-6 4.0 L</b>		
2001; Lev-R-Vent Radiator Cap .....	✓10327	13	2011-2010; Lev-R-Vent Radiator Cap .....	10333	16
2001; OE Type Radiator Cap .....	10227	13	2011-2010; OE Type Radiator Cap .....	10233	16
2001; OE Equivalent Fuel Cap .....	10834		2011-2010; OE Equivalent Fuel Cap .....	10838	
2001; Regular Locking Fuel Cap .....	10504		2011-2010; Regular Locking Fuel Cap .....	10508	
2001; Oil Filler Cap .....	10107		2009; Lev-R-Vent Radiator Cap .....	10333	16
			2009; OE Type Radiator Cap .....	10233	16

✓ Check Hood Clearance prior to installing this Cap.

## Caps for Passenger Cars and Light Trucks (1990 and Newer)

Application	Part Number	PSI	Application	Part Number	PSI
<b>Nissan - Continued</b>			<b>Nissan - Continued</b>		
<b>Pathfinder - Continued</b>			<b>Quest - Continued</b>		
<b>V-6 4.0 L - Continued</b>			<b>V-6 3.3 L - Continued</b>		
2009; OE Equivalent Fuel Cap .....	10838		1999; OE Type Radiator Cap .....	10227	13
2009; Regular Locking Fuel Cap .....	10508		1999; OE Equivalent Fuel Cap .....	10817	
2009; Oil Filler Cap .....	10107		1999; Pre-Vent Non-Locking Fuel Cap .....	10819	
2008-2005; Lev-R-Vent Radiator Cap .....	✓10333	16	1999; Regular Locking Fuel Cap .....	10591	
2008-2005; OE Type Radiator Cap .....	10233	16	1999; Pre-Vent Locking Fuel Cap .....	10501	
2008-2005; OE Equivalent Fuel Cap .....	10838		1999; Oil Filler Cap .....	10107	
2008-2005; Regular Locking Fuel Cap .....	10508				
2008-2005; Oil Filler Cap .....	10107		<b>V-6 3.5 L</b>		
<b>V-8 5.6 L</b>			2011; Oil Filler Cap .....	10107	
2011; OE Equivalent Fuel Cap .....	10838		2009-2004; Lev-R-Vent Radiator Cap .....	✓10327	13
2011; Regular Locking Fuel Cap .....	10508		2009-2004; OE Type Radiator Cap .....	10227	13
2010; Lev-R-Vent Radiator Cap .....	10333	16	2009-2004; OE Equivalent Fuel Cap .....	10838	
2010; OE Type Radiator Cap .....	10233	16	2009-2004; Regular Locking Fuel Cap .....	10508	
2010; OE Equivalent Fuel Cap .....	10838		2009-2004; Oil Filler Cap .....	10107	
2010; Regular Locking Fuel Cap .....	10508				
2009; Lev-R-Vent Radiator Cap .....	10333	16	<b>Rogue</b>		
2009; OE Type Radiator Cap .....	10233	16	<b>4-Cyl. 2.5 L</b>		
2009; OE Equivalent Fuel Cap .....	10838		2012-2011; OE Equivalent Fuel Cap .....	10838	
2009; Regular Locking Fuel Cap .....	10508		2012-2011; Regular Locking Fuel Cap .....	10508	
2009; Oil Filler Cap .....	10107		2010-2008; Lev-R-Vent Radiator Cap .....	10327	13
2008; Lev-R-Vent Radiator Cap .....	✓10333	16	2010-2008; OE Type Radiator Cap .....	10227	13
2008; OE Type Radiator Cap .....	10233	16	2010-2008; OE Equivalent Fuel Cap .....	10838	
2008; OE Equivalent Fuel Cap .....	10838		2010-2008; Regular Locking Fuel Cap .....	10508	
2008; Regular Locking Fuel Cap .....	10508		2010-2008; Oil Filler Cap .....	10107	
2008; Oil Filler Cap .....	10107				
2004; OE Type Radiator Cap .....	10264	42	<b>Sentra</b>		
2004; Coolant Recovery Tank Cap .....	10238		<b>4-Cyl. 1.6 L</b>		
2004; OE Equivalent Fuel Cap .....	10838		1999-1995; Lev-R-Vent Radiator Cap .....	✓10327	13
2004; Regular Locking Fuel Cap .....	10508		1999-1995; OE Type Radiator Cap .....	10227	13
2004; Oil Filler Cap .....	10107		1999-1995; OE Equivalent Fuel Cap .....	10817	
			1999-1995; Pre-Vent Non-Locking Fuel Cap .....	10819	
			1999-1995; Regular Locking Fuel Cap .....	10591	
			1999-1995; Pre-Vent Locking Fuel Cap .....	10501	
			1999-1995; Oil Filler Cap .....	10107	
<b>Pickup</b>			<b>4-Cyl. 1.8 L</b>		
<b>4-Cyl. 2.4 L</b>			2006-2000; Lev-R-Vent Radiator Cap .....	✓10327	13
1997-1995; Lev-R-Vent Radiator Cap .....	✓10327	13	2006-2000; OE Type Radiator Cap .....	10227	13
1997-1995; OE Type Radiator Cap .....	10227	13	2006-2000; OE Equivalent Fuel Cap .....	10838	
1997-1995; OE Equivalent Fuel Cap .....	10817		2006-2000; Regular Locking Fuel Cap .....	10508	
1997-1995; Pre-Vent Non-Locking Fuel Cap .....	10819		2006-2000; Oil Filler Cap .....	10107	
1997-1995; Regular Locking Fuel Cap .....	10591				
1997-1995; Pre-Vent Locking Fuel Cap .....	10501		<b>4-Cyl. 2.0 L</b>		
1997-1995; Oil Filler Cap .....	10107		2012; OE Equivalent Fuel Cap .....	10838	
<b>4-Cyl. 2.4 L (Non-US)</b>			2012; Regular Locking Fuel Cap .....	10508	
2007-1998; Lev-R-Vent Radiator Cap .....	✓10327	13	2011-2010; Lev-R-Vent Radiator Cap .....	10327	13
2007-1998; OE Type Radiator Cap .....	10227	13	2011-2010; OE Type Radiator Cap .....	10227	13
<b>V-6 3.0 L</b>			2011-2010; OE Equivalent Fuel Cap .....	10838	
1995; Lev-R-Vent Radiator Cap .....	✓10327	13	2011-2010; Regular Locking Fuel Cap .....	10508	
1995; OE Type Radiator Cap .....	10227	13	2009-2007; Lev-R-Vent Radiator Cap .....	✓10327	13
1995; OE Equivalent Fuel Cap .....	10817		2009-2007; OE Type Radiator Cap .....	10227	13
1995; Pre-Vent Non-Locking Fuel Cap .....	10819		2009-2007; OE Equivalent Fuel Cap .....	10838	
1995; Regular Locking Fuel Cap .....	10591		2009-2007; Regular Locking Fuel Cap .....	10508	
1995; Pre-Vent Locking Fuel Cap .....	10501		2009-2007; Oil Filler Cap .....	10107	
1995; Oil Filler Cap .....	10107		2001-2000; Lev-R-Vent Radiator Cap .....	✓10327	13
<b>V-6 3.0 L (Canada)</b>			2001-2000; OE Type Radiator Cap .....	10227	13
1996; Lev-R-Vent Radiator Cap .....	✓10327	13	2001-2000; OE Equivalent Fuel Cap .....	10838	
1996; OE Type Radiator Cap .....	10227	13	2001-2000; Regular Locking Fuel Cap .....	10508	
			2001-2000; Oil Filler Cap .....	10107	
<b>Quest</b>			2001-2000; Lev-R-Vent Radiator Cap .....	✓10327	13
<b>V-6 3.0 L</b>			1999-1998; OE Type Radiator Cap .....	10227	13
1998-1995; Lev-R-Vent Radiator Cap .....	✓10327	13	1999-1998; OE Equivalent Fuel Cap .....	10817	
1998-1995; OE Type Radiator Cap .....	10227	13	1999-1998; Pre-Vent Non-Locking Fuel Cap .....	10819	
1998-1995; OE Equivalent Fuel Cap .....	10817		1999-1998; Regular Locking Fuel Cap .....	10591	
1998-1995; Pre-Vent Non-Locking Fuel Cap .....	10819		1999-1998; Pre-Vent Locking Fuel Cap .....	10501	
1998-1995; Regular Locking Fuel Cap .....	10591		1999-1998; Oil Filler Cap .....	10107	
1998-1995; Pre-Vent Locking Fuel Cap .....	10501				
1998-1995; Oil Filler Cap .....	10107		<b>4-Cyl. 2.5 L</b>		
<b>V-6 3.3 L</b>			2012; OE Equivalent Fuel Cap .....	10838	
2002-2000; Lev-R-Vent Radiator Cap .....	✓10327	13	2012; Regular Locking Fuel Cap .....	10508	
2002-2000; OE Type Radiator Cap .....	10227	13	2011-2010; Lev-R-Vent Radiator Cap .....	10327	13
2002-2000; OE Equivalent Fuel Cap .....	10838		2011-2010; OE Type Radiator Cap .....	10227	13
2002-2000; Regular Locking Fuel Cap .....	10508		2011-2010; OE Equivalent Fuel Cap .....	10838	
2002-2000; Oil Filler Cap .....	10107		2011-2010; Regular Locking Fuel Cap .....	10508	
1999; Lev-R-Vent Radiator Cap .....	✓10327	13	2009-2002; Lev-R-Vent Radiator Cap .....	✓10327	13
			2009-2002; OE Type Radiator Cap .....	10227	13

✓ Check Hood Clearance prior to installing this Cap.



## Caps for Passenger Cars and Light Trucks (1990 and Newer)

Application	Part Number	PSI	Application	Part Number	PSI
<b>Nissan - Continued</b>			<b>Nissan - Continued</b>		
<b>Sentra - Continued</b>			<b>Xterra - Continued</b>		
<b>4-Cyl. 2.5 L - Continued</b>			<b>4-Cyl. 2.4 L; V-6 3.3 L - Continued</b>		
2009-2002: OE Equivalent Fuel Cap .....	10838		2004-2001: Oil Filler Cap .....	10107	
2009-2002: Regular Locking Fuel Cap .....	10508		2000: Lev-R-Vent Radiator Cap .....	✓10327	13
2009-2002: Oil Filler Cap .....	10107		2000: OE Type Radiator Cap .....	10227	13
<b>Titan</b>			2000: OE Equivalent Fuel Cap .....		
<b>V-8 5.6 L</b>			2000: Pre-Vent Non-Locking Fuel Cap .....		
2011: OE Equivalent Fuel Cap .....	10838		2000: Regular Locking Fuel Cap .....	10591	
2011: Regular Locking Fuel Cap .....	10508		2000: Pre-Vent Locking Fuel Cap .....	10501	
2011: Flex Fuel Regular Fuel Cap .....	10838Y		2000: Oil Filler Cap .....	10107	
2011: Flex Fuel Regular Locking Fuel Cap .....	10508Y		<b>V-6 4.0 L</b>		
2010: OE Type Radiator Cap .....	10264	42	2012: Lev-R-Vent Radiator Cap .....	10333	16
2010: OE Equivalent Fuel Cap .....	10838		2012: OE Type Radiator Cap .....	10233	16
2010: Regular Locking Fuel Cap .....	10508		2011-2010: Lev-R-Vent Radiator Cap .....	10333	16
2009: OE Type Radiator Cap .....	10264	42	2011-2010: OE Type Radiator Cap .....	10233	16
2009: Coolant Recovery Tank Cap .....	10238		2011-2010: OE Equivalent Fuel Cap .....	10838	
2009: OE Equivalent Fuel Cap .....	10838		2011-2010: Regular Locking Fuel Cap .....	10508	
2009: Regular Locking Fuel Cap .....	10508		2009: Lev-R-Vent Radiator Cap .....	10333	16
2009: Oil Filler Cap .....	10107		2009: OE Type Radiator Cap .....	10233	16
2008-2007: OE Type Radiator Cap .....	10264	42	2009: OE Equivalent Fuel Cap .....	10838	
2008-2007: Coolant Recovery Tank Cap .....	10238		2009: Regular Locking Fuel Cap .....	10508	
2008-2007: OE Equivalent Fuel Cap .....	10838		2009: Oil Filler Cap .....	10107	
2008-2007: Flex Fuel Regular Fuel Cap .....	10838Y		2008-2005: Lev-R-Vent Radiator Cap .....	✓10333	16
2008-2007: Regular Locking Fuel Cap .....	10508		2008-2005: OE Type Radiator Cap .....	10233	16
2008-2007: Flex Fuel Regular Locking Fuel Cap .....	10508Y		2008-2005: OE Equivalent Fuel Cap .....	10838	
2008-2007: Oil Filler Cap .....	10107		2008-2005: Regular Locking Fuel Cap .....	10508	
2006-2004: OE Type Radiator Cap .....	10264	42	2008-2005: Oil Filler Cap .....	10107	
2006-2004: Coolant Recovery Tank Cap .....	10238		<b>Oldsmobile</b>		
2006-2004: OE Equivalent Fuel Cap .....	10838		<b>Achieva</b>		
2006-2004: Regular Locking Fuel Cap .....	10508		<b>4-Cyl. 2.3 L</b>		
2006-2004: Oil Filler Cap .....	10107		1995: OE Type Radiator Cap .....	10239	15
<b>Tsubame</b>			1995: OE Equivalent Fuel Cap .....	10817	
<b>4-Cyl. 1.6 L (Non-US)</b>			1995: Pre-Vent Non-Locking Fuel Cap .....	10819	
2003: Lev-R-Vent Radiator Cap .....	✓10327	13	1995: Regular Locking Fuel Cap .....	10591	
2003: OE Type Radiator Cap .....	10227	13	1995: Pre-Vent Locking Fuel Cap .....	10501	
1999: Lev-R-Vent Radiator Cap .....	✓10327	13	1995: Oil Filler Cap .....	10132	
1999: OE Type Radiator Cap .....	10227	13	<b>4-Cyl. 2.4 L</b>		
1996-1995: Lev-R-Vent Radiator Cap .....	✓10327	13	1998-1997: OE Type Radiator Cap .....	10239	15
1996-1995: OE Type Radiator Cap .....	10227	13	1998-1997: OE Equivalent Fuel Cap .....	10836	
<b>Versa</b>			1998-1997: Regular Locking Fuel Cap .....	10506	
<b>4-Cyl. 1.6 L</b>			1998-1997: Oil Filler Cap .....	10105	
2011: Lev-R-Vent Radiator Cap .....	10327	13	1996: OE Type Radiator Cap .....	10239	15
2011: OE Type Radiator Cap .....	10227	13	1996: OE Equivalent Fuel Cap .....	10834	
2010: Lev-R-Vent Radiator Cap .....	10327	13	1996: Regular Locking Fuel Cap .....	10504	
2010: OE Type Radiator Cap .....	10227	13	1996: Oil Filler Cap .....	10105	
2010: OE Equivalent Fuel Cap .....	10838		<b>V-6 3.1 L</b>		
2010: Regular Locking Fuel Cap .....	10508		1998-1997: OE Type Radiator Cap .....	10239	15
2010: Oil Filler Cap .....	10107		1998-1997: OE Equivalent Fuel Cap .....	10836	
2009: Lev-R-Vent Radiator Cap .....	✓10327	13	1998-1997: Regular Locking Fuel Cap .....	10506	
2009: OE Type Radiator Cap .....	10227	13	1998-1997: Oil Filler Cap .....	10099	
2009: OE Equivalent Fuel Cap .....	10838		1996: OE Type Radiator Cap .....	10239	15
2009: Regular Locking Fuel Cap .....	10508		1996: OE Equivalent Fuel Cap .....	10834	
2009: Oil Filler Cap .....	10107		1996: Regular Locking Fuel Cap .....	10504	
<b>4-Cyl. 1.8 L</b>			1996: Oil Filler Cap .....	10099	
2011: Lev-R-Vent Radiator Cap .....	10327	13	1995: OE Type Radiator Cap .....	10239	15
2011: OE Type Radiator Cap .....	10227	13	1995: OE Equivalent Fuel Cap .....	10817	
2010: Lev-R-Vent Radiator Cap .....	10327	13	1995: Pre-Vent Non-Locking Fuel Cap .....	10819	
2010: OE Type Radiator Cap .....	10227	13	1995: Regular Locking Fuel Cap .....	10591	
2010: OE Equivalent Fuel Cap .....	10838		1995: Pre-Vent Locking Fuel Cap .....	10501	
2010: Regular Locking Fuel Cap .....	10508		1995: Oil Filler Cap .....	10099	
2009-2007: Lev-R-Vent Radiator Cap .....	✓10327	13	<b>Alero</b>		
2009-2007: OE Type Radiator Cap .....	10227	13	<b>4-Cyl. 2.2 L</b>		
2009-2007: OE Equivalent Fuel Cap .....	10838		2004-2002: OE Type Radiator Cap .....	10248	15
2009-2007: Regular Locking Fuel Cap .....	10508		2004-2002: OE Equivalent Fuel Cap .....	10836	
2009-2007: Oil Filler Cap .....	10107		2004-2002: Regular Locking Fuel Cap .....	10506	
<b>Xterra</b>			2004-2002: Oil Filler Cap .....	10099	
<b>4-Cyl. 2.4 L; V-6 3.3 L</b>			<b>4-Cyl. 2.4 L</b>		
2004-2001: Lev-R-Vent Radiator Cap .....	✓10327	13	2001-1999: OE Type Radiator Cap .....	10248	15
2004-2001: OE Type Radiator Cap .....	10227	13	2001-1999: OE Equivalent Fuel Cap .....	10836	
2004-2001: OE Equivalent Fuel Cap .....	10838		2001-1999: Regular Locking Fuel Cap .....	10506	
2004-2001: Regular Locking Fuel Cap .....	10508		2001-1999: Oil Filler Cap .....	10105	

✓ Check Hood Clearance prior to installing this Cap.

## Caps for Passenger Cars and Light Trucks (1990 and Newer)

Application	Part Number	PSI	Application	Part Number	PSI
<b>Oldsmobile - Continued</b>			<b>Oldsmobile - Continued</b>		
<b>Alero - Continued</b>			<b>Cutlass Supreme</b>		
<b>V-6 3.4 L</b>			<b>V-6 3.1 L</b>		
2004-1999: OE Type Radiator Cap .....	10248	15	1997-1995: Lev-R-Vent Radiator Cap .....	10331	16
2004-1999: OE Equivalent Fuel Cap .....	10836		1997-1995: OE Type Radiator Cap .....	10231	16
2004-1999: Regular Locking Fuel Cap .....	10506		1997-1995: OE Equivalent Fuel Cap .....	10817	
2004-1999: Oil Filler Cap .....	10099		1997-1995: Pre-Vent Non-Locking Fuel Cap .....	10819	
<b>Aurora</b>			1997-1995: Regular Locking Fuel Cap .....		
<b>V-6 3.5 L</b>			1997-1995: Pre-Vent Locking Fuel Cap .....		
2002-2001: Lev-R-Vent Radiator Cap .....	10334	18	1997-1995: Oil Filler Cap .....	10099	
2002-2001: OE Type Radiator Cap .....	10234	18	<b>V-6 3.4 L</b>		
2002-2001: OE Equivalent Fuel Cap .....	10836		1996-1995: Lev-R-Vent Radiator Cap .....	10331	16
2002-2001: Regular Locking Fuel Cap .....	10506		1996-1995: OE Type Radiator Cap .....	10231	16
2002-2001: Oil Filler Cap .....	10099		1996-1995: OE Equivalent Fuel Cap .....	10817	
<b>V-8 4.0 L</b>			1996-1995: Pre-Vent Non-Locking Fuel Cap .....		
2003-2001: Lev-R-Vent Radiator Cap .....	10334	18	1996-1995: Regular Locking Fuel Cap .....		
2003-2001: OE Type Radiator Cap .....	10234	18	1996-1995: Pre-Vent Locking Fuel Cap .....		
2003-2001: OE Equivalent Fuel Cap .....	10836		1996-1995: Oil Filler Cap .....		
2003-2001: Regular Locking Fuel Cap .....	10506		<b>Eighty Eight</b>		
2003-2001: Oil Filler Cap .....	10099		<b>V-6 3.8 L</b>		
1999-1998: OE Type Radiator Cap .....	10239	15	1999-1998: Lev-R-Vent Radiator Cap .....	10331	16
1999-1998: OE Equivalent Fuel Cap .....	10836		1999-1998: OE Type Radiator Cap .....	10231	16
1999-1998: Regular Locking Fuel Cap .....	10506		1999-1998: OE Equivalent Fuel Cap .....	10836	
1999-1998: Oil Filler Cap .....	10099		1999-1998: Regular Locking Fuel Cap .....	10506	
1997-1995: OE Type Radiator Cap .....	10239	15	1999-1998: Oil Filler Cap .....	10099	
1997-1995: OE Equivalent Fuel Cap .....	10817		1997: Lev-R-Vent Radiator Cap .....	10331	16
1997-1995: Pre-Vent Non-Locking Fuel Cap .....	10819		1997: OE Type Radiator Cap .....	10231	16
1997-1995: Regular Locking Fuel Cap .....	10591		1997: OE Equivalent Fuel Cap .....	10834	
1997-1995: Pre-Vent Locking Fuel Cap .....	10501		1997: Regular Locking Fuel Cap .....	10504	
1997-1995: Oil Filler Cap .....	10099		1997: Oil Filler Cap .....	10099	
<b>Bravada</b>			1996: Lev-R-Vent Radiator Cap .....		
<b>6-Cyl. 4.2 L</b>			1996: OE Type Radiator Cap .....		
2004-2002: OE Type Radiator Cap .....	10248	15	1996: OE Equivalent Fuel Cap; Eng. VIN K .....	10834	
2004-2002: OE Equivalent Fuel Cap .....	10836		1996: Regular Locking Fuel Cap; Eng. VIN K .....	10504	
2004-2002: Regular Locking Fuel Cap .....	10506		1996: OE Equivalent Fuel Cap; Eng. VIN 1 .....	10817	
2004-2002: Oil Filler Cap .....	10099		1996: Pre-Vent Non-Locking Fuel Cap; Eng. VIN 1 .....	10819	
<b>V-6 4.3 L</b>			1996: Regular Locking Fuel Cap; Eng. VIN 1 .....		
2001-1996: Lev-R-Vent Radiator Cap .....	10330	16	1996: Pre-Vent Locking Fuel Cap; Eng. VIN 1 .....		
2001-1996: OE Type Radiator Cap .....	10230	16	1996: Oil Filler Cap .....		
2001-1996: OE Equivalent Fuel Cap .....	10836		1995: Lev-R-Vent Radiator Cap .....		
2001-1996: Regular Locking Fuel Cap .....	10506		1995: OE Type Radiator Cap .....		
2001-1996: Oil Filler Cap .....	10099		1995: OE Equivalent Fuel Cap .....		
<b>Cutlass</b>			1995: Pre-Vent Non-Locking Fuel Cap .....		
<b>V-6 3.1 L</b>			1995: Regular Locking Fuel Cap .....		
1999: OE Type Radiator Cap .....	10248	15	1995: Pre-Vent Locking Fuel Cap .....		
1999: OE Equivalent Fuel Cap .....	10836		1995: Oil Filler Cap .....		
1999: Regular Locking Fuel Cap .....	10506		<b>Intrigue</b>		
1999: Oil Filler Cap .....	10099		<b>V-6 3.5 L</b>		
1998-1997: OE Type Radiator Cap .....	10239	15	2002-2000: OE Type Radiator Cap .....		
1998-1997: OE Equivalent Fuel Cap .....	10836		2002-2000: OE Equivalent Fuel Cap .....		
1998-1997: Regular Locking Fuel Cap .....	10506		2002-2000: Regular Locking Fuel Cap .....		
1998-1997: Oil Filler Cap .....	10099		2002-2000: Oil Filler Cap .....		
<b>Cutlass Ciera</b>			1999: OE Type Radiator Cap .....		
<b>4-Cyl. 2.2 L</b>			1999: OE Equivalent Fuel Cap .....		
1996-1995: Lev-R-Vent Radiator Cap .....	10331	16	1999: Regular Locking Fuel Cap .....		
1996-1995: OE Type Radiator Cap .....	10231	16	1999: Oil Filler Cap .....		
1996-1995: OE Equivalent Fuel Cap .....	10817		<b>V-6 3.8 L</b>		
1996-1995: Pre-Vent Non-Locking Fuel Cap .....	10819		<b>V-6 3.8 L</b>		
1996-1995: Regular Locking Fuel Cap .....	10591		1999-1998: Lev-R-Vent Radiator Cap .....		
1996-1995: Pre-Vent Locking Fuel Cap .....	10501		1999-1998: OE Type Radiator Cap .....		
1996-1995: Oil Filler Cap .....	10122		1999-1998: OE Equivalent Fuel Cap .....		
<b>V-6 3.1 L</b>			1999-1998: Regular Locking Fuel Cap .....		
1996-1995: Lev-R-Vent Radiator Cap .....	10331	16	1999-1998: Oil Filler Cap .....		
1996-1995: OE Type Radiator Cap .....	10231	16	<b>LSS</b>		
1996-1995: OE Equivalent Fuel Cap .....	10817		<b>V-6 3.8 L</b>		
1996-1995: Pre-Vent Non-Locking Fuel Cap .....	10819		1999-1998: Lev-R-Vent Radiator Cap .....		
1996-1995: Regular Locking Fuel Cap .....	10591		1999-1998: OE Type Radiator Cap .....		
1996-1995: Pre-Vent Locking Fuel Cap .....	10501		1999-1998: OE Equivalent Fuel Cap .....		
1996-1995: Oil Filler Cap .....	10099		1999-1998: Regular Locking Fuel Cap .....		
			1999-1998: Oil Filler Cap .....		
			1997: Lev-R-Vent Radiator Cap .....		
			1997: OE Type Radiator Cap .....		
			1997: OE Equivalent Fuel Cap; Eng. VIN 1 .....		

## Caps for Passenger Cars and Light Trucks (1990 and Newer)

Application	Part Number	PSI	Application	Part Number	PSI
<b>Oldsmobile - Continued</b>			<b>Plymouth - Continued</b>		
<b>LSS - Continued</b>			<b>Breeze</b>		
<b>V-6 3.8 L - Continued</b>			<b>4-Cyl. 2.0 L</b>		
1997; Regular Locking Fuel Cap; Eng. VIN 1 .....	10506		2000; Lev-R-Vent Radiator Cap .....	10331	16
1997; OE Equivalent Fuel Cap; Eng. VIN K .....	10834		2000; OE Type Radiator Cap .....	10231	16
1997; Regular Locking Fuel Cap; Eng. VIN K .....	10504		2000; OE Equivalent Fuel Cap .....	10838	
1997; Oil Filler Cap .....	10099		2000; Regular Locking Fuel Cap .....	10508	
<b>Ninety Eight</b>			2000; Oil Filler Cap .....	10111	
<b>V-6 3.8 L</b>			1999-1996; Lev-R-Vent Radiator Cap .....	10331	16
1996-1995; Lev-R-Vent Radiator Cap .....	10331	16	1999-1996; OE Type Radiator Cap .....	10231	16
1996-1995; OE Type Radiator Cap .....	10231	16	1999-1996; OE Equivalent Fuel Cap .....	10817	
1996-1995; OE Equivalent Fuel Cap .....	10817		1999-1996; Pre-Vent Non-Locking Fuel Cap .....	10819	
1996-1995; Pre-Vent Non-Locking Fuel Cap .....	10819		1999-1996; Regular Locking Fuel Cap .....	10591	
1996-1995; Regular Locking Fuel Cap .....	10591		1999-1996; Pre-Vent Locking Fuel Cap .....	10501	
1996-1995; Pre-Vent Locking Fuel Cap .....	10501		1999-1996; Oil Filler Cap .....	10111	
1996-1995; Oil Filler Cap .....	10099		<b>4-Cyl. 2.4 L</b>		
<b>Regency</b>			2000; Lev-R-Vent Radiator Cap .....	10331	16
<b>V-6 3.8 L</b>			2000; OE Type Radiator Cap .....	10231	16
1998; Lev-R-Vent Radiator Cap .....	10331	16	2000; OE Equivalent Fuel Cap .....	10838	
1998; OE Type Radiator Cap .....	10231	16	2000; Regular Locking Fuel Cap .....	10508	
1998; OE Equivalent Fuel Cap .....	10836		2000; Oil Filler Cap .....	10111	
1998; Regular Locking Fuel Cap .....	10506		1999-1998; Lev-R-Vent Radiator Cap .....	10331	16
1998; Oil Filler Cap .....	10099		1999-1998; OE Type Radiator Cap .....	10231	16
1997; Lev-R-Vent Radiator Cap .....	10331	16	1999-1998; OE Equivalent Fuel Cap .....	10817	
1997; OE Type Radiator Cap .....	10231	16	1999-1998; Pre-Vent Non-Locking Fuel Cap .....	10819	
1997; OE Equivalent Fuel Cap .....	10834		1999-1998; Regular Locking Fuel Cap .....	10591	
1997; Regular Locking Fuel Cap .....	10504		1999-1998; Pre-Vent Locking Fuel Cap .....	10501	
1997; Oil Filler Cap .....	10099		1999-1998; Oil Filler Cap .....	10111	
<b>Silhouette</b>			1997; Lev-R-Vent Radiator Cap .....	10331	16
<b>V-6 3.4 L</b>			1997; OE Type Radiator Cap .....	10231	16
2004-1998; Lev-R-Vent Radiator Cap .....	10331	16	1997; OE Equivalent Fuel Cap .....	10817	
2004-1998; OE Type Radiator Cap .....	10231	16	1997; Pre-Vent Non-Locking Fuel Cap .....	10819	
2004-1998; OE Equivalent Fuel Cap .....	10836		1997; Regular Locking Fuel Cap .....	10591	
2004-1998; Regular Locking Fuel Cap .....	10506		1997; Pre-Vent Locking Fuel Cap .....	10501	
2004-1998; Oil Filler Cap .....	10099		1997-1996; Oil Filler Cap .....	10099	
1997-1996; Lev-R-Vent Radiator Cap .....	10331	16	<b>Grand Voyager</b>		
1997-1996; OE Type Radiator Cap .....	10231	16	<b>4-Cyl. 2.4 L</b>		
1997-1996; OE Equivalent Fuel Cap .....	10817		1997-1996; Lev-R-Vent Radiator Cap .....	10331	16
1997-1996; Pre-Vent Non-Locking Fuel Cap .....	10819		1997-1996; OE Type Radiator Cap .....	10231	16
1997-1996; Regular Locking Fuel Cap .....	10591		1997-1996; OE Equivalent Fuel Cap .....	10817	
1997-1996; Pre-Vent Locking Fuel Cap .....	10501		1997-1996; Pre-Vent Non-Locking Fuel Cap .....	10819	
1997-1996; Oil Filler Cap .....	10099		1997-1996; Regular Locking Fuel Cap .....	10591	
<b>V-6 3.8 L</b>			1997-1996; Pre-Vent Locking Fuel Cap .....	10501	
1995; Lev-R-Vent Radiator Cap .....	10331	16	1997-1996; Oil Filler Cap .....	10111	
1995; OE Type Radiator Cap .....	10231	16	<b>V-6 3.0 L</b>		
1995; OE Equivalent Fuel Cap .....	10817		2000; Lev-R-Vent Radiator Cap .....	10331	16
1995; Pre-Vent Non-Locking Fuel Cap .....	10819		2000; OE Type Radiator Cap .....	10231	16
1995; Regular Locking Fuel Cap .....	10591		2000; OE Equivalent Fuel Cap .....	10838	
1995; Pre-Vent Locking Fuel Cap .....	10501		2000; Regular Locking Fuel Cap .....	10508	
1995; Oil Filler Cap .....	10099		2000; Oil Filler Cap .....	10088	
<b>Plymouth</b>			1999; Lev-R-Vent Radiator Cap .....	10331	16
<b>Acclaim</b>			1999; OE Type Radiator Cap .....	10231	16
<b>4-Cyl. 2.5 L</b>			1999; OE Equivalent Fuel Cap; Nov. 1, 1998 & Newer .....	10838	
1995; Lev-R-Vent Radiator Cap .....	10331	16	1999; Regular Locking Fuel Cap; Nov. 1, 1998 & Newer .....	10508	
1995; OE Type Radiator Cap .....	10231	16	1999; OE Equivalent Fuel Cap; Oct. 31, 1998 & Older .....	10817	
1995; OE Equivalent Fuel Cap .....	10817		1999; Pre-Vent Non-Locking Fuel Cap; Oct. 31, 1998 & Older ...	10819	
1995; Pre-Vent Non-Locking Fuel Cap .....	10819		1999; Regular Locking Fuel Cap; Oct. 31, 1998 & Older .....	10591	
1995; Regular Locking Fuel Cap .....	10591		1999; Pre-Vent Locking Fuel Cap; Oct. 31, 1998 & Older .....	10501	
1995; Pre-Vent Locking Fuel Cap .....	10501		1999; Oil Filler Cap .....	10088	
1995; Oil Filler Cap .....	10111		1998-1995; Lev-R-Vent Radiator Cap .....	10331	16
<b>V-6 3.0 L</b>			1998-1995; OE Type Radiator Cap .....	10231	16
1995; Lev-R-Vent Radiator Cap .....	10331	16	1998-1995; OE Equivalent Fuel Cap .....	10817	
1995; OE Type Radiator Cap .....	10231	16	1998-1995; Pre-Vent Non-Locking Fuel Cap .....	10819	
1995; OE Equivalent Fuel Cap .....	10817		1998-1995; Regular Locking Fuel Cap .....	10591	
1995; Pre-Vent Non-Locking Fuel Cap .....	10819		1998-1995; Pre-Vent Locking Fuel Cap .....	10501	
1995; Regular Locking Fuel Cap .....	10591		1998-1995; Oil Filler Cap .....	10088	
1995; Pre-Vent Locking Fuel Cap .....	10501		<b>V-6 3.3 L</b>		
1995; Oil Filler Cap .....	10088		2000; Lev-R-Vent Radiator Cap .....	10331	16

## Caps for Passenger Cars and Light Trucks (1990 and Newer)

Application	Part Number	PSI	Application	Part Number	PSI
<b>Plymouth - Continued</b>			<b>Plymouth - Continued</b>		
<b>Grand Voyager - Continued</b>			<b>Neon - Continued</b>		
<b>V-6 3.3 L - Continued</b>			<b>4-Cyl. 2.0 L - Continued</b>		
2000: OE Type Radiator Cap .....	10231	16	1998-1995: Lev-R-Vent Radiator Cap .....	10330	16
2000: OE Equivalent Fuel Cap .....	10838		1998-1995: OE Type Radiator Cap .....	10230	16
2000: Flex Fuel Regular Fuel Cap .....	10838Y		1998-1995: OE Equivalent Fuel Cap .....	10817	
2000: Regular Locking Fuel Cap .....	10508		1998-1995: Pre-Vent Non-Locking Fuel Cap .....	10819	
2000: Flex Fuel Regular Locking Fuel Cap .....	10508Y		1998-1995: Regular Locking Fuel Cap .....	10591	
2000: Oil Filler Cap .....	10111		1998-1995: Pre-Vent Locking Fuel Cap .....	10501	
1999: Lev-R-Vent Radiator Cap .....	10331	16	1998-1995: Oil Filler Cap .....	10111	
1999: OE Type Radiator Cap .....	10231	16	<b>Prowler</b>		
1999: OE Equivalent Fuel Cap; Nov. 1, 1998 & Newer .....	10838		<b>V-6 3.5 L</b>		
1999: Flex Fuel Regular Fuel Cap; Nov. 1, 1998 & Newer .....	10838Y		2001: Lev-R-Vent Radiator Cap .....	10330	16
1999: Regular Locking Fuel Cap; Nov. 1, 1998 & Newer .....	10508		2001: OE Type Radiator Cap .....	10230	16
1999: Flex Fuel Regular Locking Fuel Cap; Nov. 1, 1998 & Newer .....	10508Y		2001: OE Equivalent Fuel Cap .....	10817	
2000: OE Equivalent Fuel Cap; Oct. 31, 1998 & Older .....	10817		2001: Pre-Vent Non-Locking Fuel Cap .....	10819	
1999: Pre-Vent Non-Locking Fuel Cap; Oct. 31, 1998 & Older .....	10819		2001: Regular Locking Fuel Cap .....	10591	
1999: Regular Locking Fuel Cap; Oct. 31, 1998 & Older .....	10591		2001: Pre-Vent Locking Fuel Cap .....	10501	
1999: Pre-Vent Locking Fuel Cap; Oct. 31, 1998 & Older .....	10501		2001: Oil Filler Cap .....	10111	
1999: Oil Filler Cap .....	10111		2000: Lev-R-Vent Radiator Cap .....	10330	16
1998-1995: Lev-R-Vent Radiator Cap .....	10331	16	2000: OE Type Radiator Cap .....	10230	16
1998-1995: OE Type Radiator Cap .....	10231	16	1999: Lev-R-Vent Radiator Cap .....	10330	16
1998-1995: OE Equivalent Fuel Cap .....	10817		1999: OE Type Radiator Cap .....	10230	16
1998-1995: Pre-Vent Non-Locking Fuel Cap .....	10819		1999: OE Equivalent Fuel Cap .....	10817	
1998-1995: Regular Locking Fuel Cap .....	10591		1999: Pre-Vent Non-Locking Fuel Cap .....	10819	
1998-1995: Pre-Vent Locking Fuel Cap .....	10501		1999: Regular Locking Fuel Cap .....	10591	
1998-1995: Oil Filler Cap .....	10066		1999: Pre-Vent Locking Fuel Cap .....	10501	
<b>V-6 3.8 L</b>			1997: Lev-R-Vent Radiator Cap .....	10330	16
1999: Lev-R-Vent Radiator Cap .....	10331	16	1997: OE Type Radiator Cap .....	10230	16
1999: OE Type Radiator Cap .....	10231	16	1997: OE Equivalent Fuel Cap .....	10817	
1999: OE Equivalent Fuel Cap; Oct. 31, 1998 & Older .....	10817		1997: Pre-Vent Non-Locking Fuel Cap .....	10819	
1999: Pre-Vent Non-Locking Fuel Cap; Oct. 31, 1998 & Older .....	10819		1997: Regular Locking Fuel Cap .....	10591	
1999: Regular Locking Fuel Cap; Oct. 31, 1998 & Older .....	10591		1997: Pre-Vent Locking Fuel Cap .....	10501	
1999: Pre-Vent Locking Fuel Cap; Oct. 31, 1998 & Older .....	10501		<b>Voyager</b>		
1999: OE Equivalent Fuel Cap; Nov. 1, 1998 & Newer .....	10838		<b>4-Cyl. 2.4 L</b>		
1999: Regular Locking Fuel Cap; Nov. 1, 1998 & Newer .....	10508		2000: Lev-R-Vent Radiator Cap .....	10331	16
1999: Oil Filler Cap .....	10111		2000: OE Type Radiator Cap .....	10231	16
1996: Lev-R-Vent Radiator Cap .....	10331	16	2000: OE Equivalent Fuel Cap .....	10838	
1996: OE Type Radiator Cap .....	10231	16	2000: Regular Locking Fuel Cap .....	10508	
1996: OE Equivalent Fuel Cap .....	10817		2000: Oil Filler Cap .....	10111	
1996: Pre-Vent Non-Locking Fuel Cap .....	10819		1999: Lev-R-Vent Radiator Cap .....	10331	16
1996: Regular Locking Fuel Cap .....	10591		1999: OE Type Radiator Cap .....	10231	16
1996: Pre-Vent Locking Fuel Cap .....	10501		1999: OE Equivalent Fuel Cap; Nov. 1, 1998 & Newer .....	10838	
1995: Lev-R-Vent Radiator Cap .....	10331	16	1999: Regular Locking Fuel Cap; Nov. 1, 1998 & Newer .....	10508	
1995: OE Type Radiator Cap .....	10231	16	1999: OE Equivalent Fuel Cap; Oct. 31, 1998 & Older .....	10817	
1995: OE Equivalent Fuel Cap .....	10817		1999: Pre-Vent Non-Locking Fuel Cap; Oct. 31, 1998 & Older .....	10819	
1995: Pre-Vent Non-Locking Fuel Cap .....	10819		1999: Regular Locking Fuel Cap; Oct. 31, 1998 & Older .....	10591	
1995: Regular Locking Fuel Cap .....	10591		1999: Pre-Vent Locking Fuel Cap; Oct. 31, 1998 & Older .....	10501	
1995: Pre-Vent Locking Fuel Cap .....	10501		1999: Oil Filler Cap .....	10111	
1995: Oil Filler Cap .....	10066		1998-1996: Lev-R-Vent Radiator Cap .....	10331	16
<b>V-6 3.8 L (Canada)</b>			1998-1996: OE Type Radiator Cap .....	10231	16
1998-1997: Lev-R-Vent Radiator Cap .....	10331	16	1998-1996: OE Equivalent Fuel Cap .....	10817	
1998-1997: OE Type Radiator Cap .....	10231	16	1998-1996: Pre-Vent Non-Locking Fuel Cap .....	10819	
1998-1997: OE Equivalent Fuel Cap .....	10817		1998-1996: Regular Locking Fuel Cap .....	10591	
1998-1997: Pre-Vent Non-Locking Fuel Cap .....	10819		1998-1996: Pre-Vent Locking Fuel Cap .....	10501	
1998-1997: Regular Locking Fuel Cap .....	10591		1998-1996: Oil Filler Cap .....	10111	
1998-1997: Pre-Vent Locking Fuel Cap .....	10501		<b>4-Cyl. 2.5 L</b>		
<b>Neon</b>			1995: Lev-R-Vent Radiator Cap .....	10331	16
<b>4-Cyl. 2.0 L</b>			1995: OE Type Radiator Cap .....	10231	16
2001-2000: Lev-R-Vent Radiator Cap .....	10330	16	1995: OE Equivalent Fuel Cap .....	10817	
2001-2000: OE Type Radiator Cap .....	10230	16	1995: Pre-Vent Non-Locking Fuel Cap .....	10819	
2001-2000: OE Equivalent Fuel Cap .....	10838		1995: Regular Locking Fuel Cap .....	10591	
2001-2000: Regular Locking Fuel Cap .....	10508		1995: Pre-Vent Locking Fuel Cap .....	10501	
2001-2000: Oil Filler Cap .....	10111		1995: Oil Filler Cap .....	10111	
1999: Lev-R-Vent Radiator Cap .....	10330	16	<b>V-6 3.0 L</b>		
1999: OE Type Radiator Cap .....	10230	16	2000: Lev-R-Vent Radiator Cap .....	10331	16
1999: OE Equivalent Fuel Cap; Dec. 31, 1998 & Older .....	10817		2000: OE Type Radiator Cap .....	10231	16
1999: Pre-Vent Non-Locking Fuel Cap; Dec. 31, 1998 & Older .....	10819		2000: OE Equivalent Fuel Cap .....	10838	
1999: Regular Locking Fuel Cap; Dec. 31, 1998 & Older .....	10591		2000: Regular Locking Fuel Cap .....	10508	
1999: Pre-Vent Locking Fuel Cap; Dec. 31, 1998 & Older .....	10501		2000: Oil Filler Cap .....	10088	
1999: OE Equivalent Fuel Cap; Jan. 1 & Newer .....	10838		1999: Lev-R-Vent Radiator Cap .....	10331	16
1999: Regular Locking Fuel Cap; Jan. 1 & Newer .....	10508		1999: OE Type Radiator Cap .....	10231	16
1999: Oil Filler Cap .....	10111		1999: OE Equivalent Fuel Cap; Nov. 1, 1998 & Newer .....	10838	

## Caps for Passenger Cars and Light Trucks (1990 and Newer)

Application	Part Number	PSI	Application	Part Number	PSI
<b>Plymouth - Continued</b>			<b>Pontiac - Continued</b>		
<b>Voyager - Continued</b>			<b>Bonneville</b>		
<b>V-6 3.0 L - Continued</b>			<b>V-6 3.8 L</b>		
1999; Regular Locking Fuel Cap; Nov. 1, 1998 & Newer .....	10508		2005-1998; Lev-R-Vent Radiator Cap .....	10331	16
1999; OE Equivalent Fuel Cap; Oct. 31, 1998 & Older .....	10817		2005-1998; OE Type Radiator Cap .....	10231	16
1999; Pre-Vent Non-Locking Fuel Cap; Oct. 31, 1998 & Older ...	10819		2005-1998; OE Equivalent Fuel Cap .....	10836	
1999; Regular Locking Fuel Cap; Oct. 31, 1998 & Older .....	10591		2005-1998; Regular Locking Fuel Cap .....	10506	
1999; Pre-Vent Locking Fuel Cap; Oct. 31, 1998 & Older .....	10501		2005-1998; Oil Filler Cap .....	10099	
1999; Oil Filler Cap .....	10088		1997; Lev-R-Vent Radiator Cap .....	10331	16
1998-1995; Lev-R-Vent Radiator Cap .....	10331	16	1997; OE Type Radiator Cap .....	10231	16
1998-1995; OE Type Radiator Cap .....	10231	16	1997; OE Equivalent Fuel Cap; Eng. VIN 1 .....	10836	
1998-1995; OE Equivalent Fuel Cap .....	10817		1997; Regular Locking Fuel Cap; Eng. VIN 1 .....	10506	
1998-1995; Pre-Vent Non-Locking Fuel Cap .....	10819		1997; OE Equivalent Fuel Cap; Eng. VIN K .....	10834	
1998-1995; Regular Locking Fuel Cap .....	10591		1997; Regular Locking Fuel Cap; Eng. VIN K .....	10504	
1998-1995; Pre-Vent Locking Fuel Cap .....	10501		1997; Oil Filler Cap .....	10099	
1998-1995; Oil Filler Cap .....	10088		1996; Lev-R-Vent Radiator Cap .....	10331	16
<b>V-6 3.3 L</b>			1996; OE Type Radiator Cap .....	10231	16
2000; Lev-R-Vent Radiator Cap .....	10331	16	1996; OE Equivalent Fuel Cap; Eng. VIN 1 .....	10817	
2000; OE Type Radiator Cap .....	10231	16	1996; Pre-Vent Non-Locking Fuel Cap; Eng. VIN 1 .....	10819	
2000; OE Equivalent Fuel Cap .....	10838		1996; Regular Locking Fuel Cap; Eng. VIN 1 .....	10591	
2000; Flex Fuel Regular Fuel Cap .....	10838Y		1996; Pre-Vent Locking Fuel Cap; Eng. VIN 1 .....	10501	
2000; Regular Locking Fuel Cap .....	10508		1996; OE Equivalent Fuel Cap; Eng. VIN K .....	10834	
2000; Flex Fuel Regular Locking Fuel Cap .....	10508Y		1996; Regular Locking Fuel Cap; Eng. VIN K .....	10504	
2000; Oil Filler Cap .....	10111		1996; Oil Filler Cap .....	10099	
1999; Lev-R-Vent Radiator Cap .....	10331	16	1995; Lev-R-Vent Radiator Cap .....	10331	16
1999; OE Type Radiator Cap .....	10231	16	1995; OE Type Radiator Cap .....	10231	16
1999; OE Equivalent Fuel Cap; Nov. 1, 1998 & Newer .....	10838		1995; OE Equivalent Fuel Cap .....	10817	
1999; Flex Fuel Regular Fuel Cap; Nov. 1, 1998 & Newer .....	10838Y		1995; Pre-Vent Non-Locking Fuel Cap .....	10819	
1999; Regular Locking Fuel Cap; Nov. 1, 1998 & Newer .....	10508		1995; Regular Locking Fuel Cap .....	10591	
1999; Flex Fuel Regular Locking Fuel Cap; Nov. 1, 1998 & Newer .....	10508Y		1995; Pre-Vent Locking Fuel Cap .....	10501	
1999; OE Equivalent Fuel Cap; Oct. 31, 1998 & Older .....	10817		1995; Oil Filler Cap .....	10099	
1999; Pre-Vent Non-Locking Fuel Cap; Oct. 31, 1998 & Older ...	10819		<b>V-8 4.6 L</b>		
1999; Regular Locking Fuel Cap; Oct. 31, 1998 & Older .....	10591		2005; Lev-R-Vent Radiator Cap .....	10334	18
1999; Pre-Vent Locking Fuel Cap; Oct. 31, 1998 & Older .....	10501		2005; OE Type Radiator Cap .....	10234	18
1999; Oil Filler Cap .....	10111		2005; OE Equivalent Fuel Cap .....	10836	
1998-1995; Lev-R-Vent Radiator Cap .....	10331	16	2005; Regular Locking Fuel Cap .....	10506	
1998-1995; OE Type Radiator Cap .....	10231	16	2005; Oil Filler Cap .....	10099	
1998-1995; OE Equivalent Fuel Cap .....	10817		2004; Lev-R-Vent Radiator Cap .....	10331	16
1998-1995; Pre-Vent Non-Locking Fuel Cap .....	10819		2004; OE Type Radiator Cap .....	10231	16
1998-1995; Regular Locking Fuel Cap .....	10591		2004; OE Equivalent Fuel Cap .....	10836	
1998-1995; Pre-Vent Locking Fuel Cap .....	10501		2004; Regular Locking Fuel Cap .....	10506	
1998-1995; Oil Filler Cap .....	10066		2004; Oil Filler Cap .....	10099	
<b>V-6 3.8 L</b>			<b>Firebird</b>		
1999; Lev-R-Vent Radiator Cap .....	10331	16	<b>V-6 3.4 L</b>		
1999; OE Type Radiator Cap .....	10231	16	1995; Lev-R-Vent Radiator Cap .....	10334	18
1999; OE Equivalent Fuel Cap; Oct. 31, 1998 & Older .....	10817		1995; OE Type Radiator Cap .....	10234	18
1999; Pre-Vent Non-Locking Fuel Cap; Oct. 31, 1998 & Older ...	10819		1995; OE Equivalent Fuel Cap .....	10822	
1999; Regular Locking Fuel Cap; Oct. 31, 1998 & Older .....	10591		1995; Pre-Vent Non-Locking Fuel Cap .....	10823	
1999; Pre-Vent Locking Fuel Cap; Oct. 31, 1998 & Older .....	10501		1995; Regular Locking Fuel Cap .....	10594	
1999; OE Equivalent Fuel Cap; Nov. 1, 1998 & Newer .....	10838		1995; Oil Filler Cap .....	10072	
1999; Regular Locking Fuel Cap; Nov. 1, 1998 & Newer .....	10508		<b>V-6 3.8 L</b>		
1996; Lev-R-Vent Radiator Cap .....	10331	16	2002-2000; Lev-R-Vent Radiator Cap .....	10334	18
1996; OE Type Radiator Cap .....	10231	16	2002-2000; OE Type Radiator Cap .....	10234	18
1996; OE Equivalent Fuel Cap .....	10817		2002-2000; Coolant Recovery Tank Cap .....	10236	
1996; Pre-Vent Non-Locking Fuel Cap .....	10819		2002-2000; OE Equivalent Fuel Cap .....	10836	
1996; Regular Locking Fuel Cap .....	10591		2002-2000; Regular Locking Fuel Cap .....	10506	
1996; Pre-Vent Locking Fuel Cap .....	10501		2002-2000; Oil Filler Cap .....	10099	
<b>V-6 3.8 L (Canada)</b>			1999; Lev-R-Vent Radiator Cap .....	10334	18
1998-1997; Lev-R-Vent Radiator Cap .....	10331	16	1999; OE Type Radiator Cap .....	10234	18
1998-1997; OE Type Radiator Cap .....	10231	16	1999; OE Equivalent Fuel Cap .....	10836	
1998-1997; OE Equivalent Fuel Cap .....	10817		1999; Regular Locking Fuel Cap .....	10506	
1998-1997; Pre-Vent Non-Locking Fuel Cap .....	10819		1999; Oil Filler Cap .....	10099	
1998-1997; Regular Locking Fuel Cap .....	10591		1998; Lev-R-Vent Radiator Cap .....	10334	18
1998-1997; Pre-Vent Locking Fuel Cap .....	10501		1998; OE Type Radiator Cap .....	10234	18
<b>Pontiac</b>			1998; OE Equivalent Fuel Cap .....	10846	
<b>Aztek</b>			1998; Regular Locking Fuel Cap .....	10516	
<b>V-6 3.4 L</b>			1998; Oil Filler Cap .....	10099	
2005-2001; Lev-R-Vent Radiator Cap .....	10331	16	1997-1995; Lev-R-Vent Radiator Cap .....	10334	18
2005-2001; OE Type Radiator Cap .....	10231	16	1997-1995; OE Type Radiator Cap .....	10234	18
2005-2001; OE Equivalent Fuel Cap .....	10836		1997-1995; OE Equivalent Fuel Cap .....	10822	
2005-2001; Regular Locking Fuel Cap .....	10506		1997-1995; Pre-Vent Non-Locking Fuel Cap .....	10823	
2005-2001; Oil Filler Cap .....	10099		1997-1995; Regular Locking Fuel Cap .....	10594	
			1997-1995; Oil Filler Cap .....	10099	

## Caps for Passenger Cars and Light Trucks (1990 and Newer)

Application	Part Number	PSI	Application	Part Number	PSI
<b>Pontiac - Continued</b>			<b>Pontiac - Continued</b>		
<b>Firebird - Continued</b>			<b>G6 - Continued</b>		
<b>V-8 5.7 L</b>			<b>V-6 3.5 L - Continued</b>		
2002-1999: Lev-R-Vent Radiator Cap .....	10334	18	2009-2006: Regular Locking Fuel Cap .....	10523	
2002-1999: OE Type Radiator Cap .....	10234	18	2009-2006: Oil Filler Cap .....	10099	
2002-1999: OE Equivalent Fuel Cap .....	10836		2005: OE Type Radiator Cap .....	10248	15
2002-1999: Regular Locking Fuel Cap .....	10506		2005: OE Equivalent Fuel Cap .....	10841	
2002-1999: Oil Filler Cap .....	10099		2005: Regular Locking Fuel Cap .....	10511	
1998: Lev-R-Vent Radiator Cap .....	10334	18	2005: Oil Filler Cap .....	10099	
1998: OE Type Radiator Cap .....	10234	18	<b>V-6 3.6 L</b>		
1998: Coolant Recovery Tank Cap .....	10236		2009-2007: OE Type Radiator Cap .....	10248	15
1998: OE Equivalent Fuel Cap .....	10846		2009-2007: OE Equivalent Fuel Cap .....	10841	
1998: Regular Locking Fuel Cap .....	10516		2009-2007: Regular Locking Fuel Cap .....	10523	
1998: Oil Filler Cap .....	10099		2009-2007: Oil Filler Cap .....	10099	
1997-1995: Lev-R-Vent Radiator Cap .....	10334	18	<b>V-6 3.9 L</b>		
1997-1995: OE Type Radiator Cap .....	10234	18	2009-2006: OE Type Radiator Cap .....	10248	15
1997-1995: OE Equivalent Fuel Cap .....	10822		2009-2006: OE Equivalent Fuel Cap .....	10841	
1997-1995: Pre-Vent Non-Locking Fuel Cap .....	10823		2009-2006: Regular Locking Fuel Cap .....	10523	
1997-1995: Regular Locking Fuel Cap .....	10594		2009-2006: Oil Filler Cap .....	10099	
1997-1995: Oil Filler Cap .....	10105		<b>G8</b>		
<b>Firefly</b>			<b>V-6 3.6 L</b>		
<b>3-Cyl. 1.0 L (Canada)</b>			2009: OE Equivalent Fuel Cap .....	10834	
2000-1998: OE Type Radiator Cap .....	10242	16	2009: Regular Locking Fuel Cap .....	10504	
2000-1998: OE Equivalent Fuel Cap .....	10825		2009: Oil Filler Cap .....	10099	
2000-1998: Regular Locking Fuel Cap .....	10595		2008: OE Equivalent Fuel Cap .....	10834	
2000-1998: Oil Filler Cap .....	10081		2008: Regular Locking Fuel Cap .....	10504	
1997-1995: OE Type Radiator Cap .....	10241	13	<b>V-8 6.0 L</b>		
1997-1995: OE Equivalent Fuel Cap .....	10825		2009-2008: OE Equivalent Fuel Cap .....	10834	
1997-1995: Regular Locking Fuel Cap .....	10595		2009-2008: Regular Locking Fuel Cap .....	10504	
1997-1995: Oil Filler Cap .....	10101		2009-2008: Oil Filler Cap .....	10099	
<b>4-Cyl. 1.3 L (Canada)</b>			<b>V-8 6.2 L</b>		
2000-1998: OE Type Radiator Cap .....	10242	16	2009: OE Equivalent Fuel Cap .....	10834	
2000-1998: OE Equivalent Fuel Cap .....	10825		2009: Regular Locking Fuel Cap .....	10504	
2000-1998: Regular Locking Fuel Cap .....	10595		<b>Grand Am</b>		
2000-1998: Oil Filler Cap .....	10081		<b>4-Cyl. 2.2 L</b>		
1997-1996: OE Type Radiator Cap .....	10241	13	2005: OE Type Radiator Cap .....	10248	15
1997-1996: OE Equivalent Fuel Cap .....	10825		2005: OE Equivalent Fuel Cap .....	10836	
1997-1996: Regular Locking Fuel Cap .....	10595		2005: Regular Locking Fuel Cap .....	10506	
1997-1996: Oil Filler Cap .....	10101		2004-2002: OE Type Radiator Cap .....	10248	15
1995: OE Type Radiator Cap .....	10242	16	2004-2002: OE Equivalent Fuel Cap .....	10836	
1995: OE Equivalent Fuel Cap .....	10825		2004-2002: Regular Locking Fuel Cap .....	10506	
1995: Regular Locking Fuel Cap .....	10595		2004-2002: Oil Filler Cap .....	10099	
1995: Oil Filler Cap .....	10101		<b>4-Cyl. 2.3 L</b>		
<b>G3</b>			1995: OE Type Radiator Cap .....	10239	15
<b>4-Cyl. 1.6 L</b>			1995: OE Equivalent Fuel Cap .....	10817	
2009: OE Type Radiator Cap .....	10259	20	1995: Pre-Vent Non-Locking Fuel Cap .....	10819	
2009: OE Equivalent Fuel Cap .....	10841		1995: Regular Locking Fuel Cap .....	10591	
<b>G5</b>			1995: Pre-Vent Locking Fuel Cap .....	10501	
<b>4-Cyl. 2.2 L</b>			1995: Oil Filler Cap .....	10132	
2009-2007: OE Type Radiator Cap .....	10248	15	<b>4-Cyl. 2.4 L</b>		
2009-2007: OE Equivalent Fuel Cap .....	10841		2001-1999: OE Type Radiator Cap .....	10248	15
2009-2007: Regular Locking Fuel Cap .....	10511		2001-1999: OE Equivalent Fuel Cap .....	10836	
2009-2007: Oil Filler Cap .....	10099		2001-1999: Regular Locking Fuel Cap .....	10506	
<b>4-Cyl. 2.4 L</b>			2001-1999: Oil Filler Cap .....	10105	
2008-2007: OE Type Radiator Cap .....	10248	15	1998-1997: OE Type Radiator Cap .....	10239	15
2008-2007: OE Equivalent Fuel Cap .....	10841		1998-1997: OE Equivalent Fuel Cap .....	10836	
2008-2007: Regular Locking Fuel Cap .....	10511		1998-1997: Regular Locking Fuel Cap .....	10506	
2008-2007: Oil Filler Cap .....	10099		1998-1997: Oil Filler Cap .....	10105	
<b>G6</b>			1996: OE Type Radiator Cap .....	10239	15
<b>4-Cyl. 2.4 L</b>			1996: OE Equivalent Fuel Cap .....	10834	
2010: OE Type Radiator Cap .....	10248	15	1996: Regular Locking Fuel Cap .....	10504	
2009: OE Type Radiator Cap .....	10248	15	1996: Oil Filler Cap .....	10105	
2009: Oil Filler Cap .....	10099		<b>V-6 3.1 L</b>		
2008-2006: OE Type Radiator Cap .....	10248	15	1998-1997: OE Type Radiator Cap .....	10239	15
2008-2006: OE Equivalent Fuel Cap .....	10841		1998-1997: OE Equivalent Fuel Cap .....	10836	
2008-2006: Regular Locking Fuel Cap .....	10523		1998-1997: Regular Locking Fuel Cap .....	10506	
2008-2006: Oil Filler Cap .....	10099		1998-1997: Oil Filler Cap .....	10099	
<b>V-6 3.5 L</b>			1996: OE Type Radiator Cap .....	10239	15
2010: OE Type Radiator Cap .....	10248	15	1996: OE Equivalent Fuel Cap .....	10834	
2009-2006: OE Type Radiator Cap .....	10248	15	1996: Regular Locking Fuel Cap .....	10504	
2009-2006: OE Equivalent Fuel Cap .....	10841		1996: Oil Filler Cap .....	10099	
			1995: OE Type Radiator Cap .....	10239	15

## Caps for Passenger Cars and Light Trucks (1990 and Newer)

Application	Part Number	PSI	Application	Part Number	PSI
<b>Pontiac - Continued</b>			<b>Pontiac - Continued</b>		
<b>Grand Am - Continued</b>			<b>GTO - Continued</b>		
<b>V-6 3.1 L - Continued</b>			<b>V-8 6.0 L</b>		
1995; OE Equivalent Fuel Cap .....	10817		2006-2005; Lev-R-Vent Radiator Cap .....	10334	18
1995; Pre-Vent Non-Locking Fuel Cap .....	10819		2006-2005; OE Type Radiator Cap .....	10234	18
1995; Regular Locking Fuel Cap .....	10591		2006-2005; OE Equivalent Fuel Cap .....	10841	
1995; Pre-Vent Locking Fuel Cap .....	10501		2006-2005; Regular Locking Fuel Cap .....	10511	
1995; Oil Filler Cap .....	10099		2006-2005; Oil Filler Cap .....	10099	
<b>V-6 3.4 L</b>			<b>Montana</b>		
2005-1999; OE Type Radiator Cap .....	10248	15	<b>V-6 3.4 L</b>		
2005-1999; OE Equivalent Fuel Cap .....	10836		2005-1999; Lev-R-Vent Radiator Cap .....	10331	16
2005-1999; Regular Locking Fuel Cap .....	10506		2005-1999; OE Type Radiator Cap .....	10231	16
2005-1999; Oil Filler Cap .....	10099		2005-1999; OE Equivalent Fuel Cap .....	10836	
<b>Grand Prix</b>			2005-1999; Regular Locking Fuel Cap .....		
<b>V-6 3.1 L</b>			2005-1999; Oil Filler Cap .....		
2003-1998; Lev-R-Vent Radiator Cap .....	10331	16	<b>V-6 3.5 L</b>		
2003-1998; OE Type Radiator Cap .....	10231	16	2006; Lev-R-Vent Radiator Cap .....	10331	16
2003-1998; OE Equivalent Fuel Cap .....	10836		2006; OE Type Radiator Cap .....	10231	16
2003-1998; Regular Locking Fuel Cap .....	10506		2006; OE Equivalent Fuel Cap .....	10841	
2003-1998; Oil Filler Cap .....	10099		2006; Regular Locking Fuel Cap .....	10511	
1997; Lev-R-Vent Radiator Cap .....	10331	16	2006; Oil Filler Cap .....	10099	
1997; OE Type Radiator Cap .....	10231	16	2005; Lev-R-Vent Radiator Cap .....	10331	16
1997; Pre-Vent Non-Locking Fuel Cap .....	10819		2005; OE Type Radiator Cap .....	10231	16
1997; Pre-Vent Locking Fuel Cap .....	10501		2005; Coolant Recovery Tank Cap .....	10236	
1997; Oil Filler Cap .....	10099		2005; OE Equivalent Fuel Cap .....	10841	
1996-1995; Lev-R-Vent Radiator Cap .....	10331	16	2005; Regular Locking Fuel Cap .....	10511	
1996-1995; OE Type Radiator Cap .....	10231	16	2005; Oil Filler Cap .....	10099	
1996-1995; OE Equivalent Fuel Cap .....	10817		<b>V-6 3.9 L</b>		
1996-1995; Pre-Vent Non-Locking Fuel Cap .....	10819		2006; OE Equivalent Fuel Cap .....	10841	
1996-1995; Regular Locking Fuel Cap .....	10591		2006; Regular Locking Fuel Cap .....	10511	
1996-1995; Pre-Vent Locking Fuel Cap .....	10501		2006; Oil Filler Cap .....	10099	
1996-1995; Oil Filler Cap .....	10099		<b>V-6 3.9 L (Canada)</b>		
<b>V-6 3.4 L</b>			2008-2007; OE Type Radiator Cap .....	10248	15
1996-1995; Lev-R-Vent Radiator Cap .....	10331	16	2008-2007; OE Equivalent Fuel Cap .....	10841	
1996-1995; OE Type Radiator Cap .....	10231	16	2008-2007; Regular Locking Fuel Cap .....	10511	
1996-1995; OE Equivalent Fuel Cap .....	10817		2008-2007; Oil Filler Cap .....	10099	
1996-1995; Pre-Vent Non-Locking Fuel Cap .....	10819		<b>Pursuit</b>		
1996-1995; Regular Locking Fuel Cap .....	10591		<b>4-Cyl. 2.2 L (Canada)</b>		
1996-1995; Pre-Vent Locking Fuel Cap .....	10501		2006-2005; OE Type Radiator Cap .....	10248	15
1996-1995; Oil Filler Cap .....	10119		2006-2005; OE Equivalent Fuel Cap .....	10841	
<b>V-6 3.8 L</b>			2006-2005; Regular Locking Fuel Cap .....	10511	
2008-2005; OE Type Radiator Cap .....	10248	15	2006-2005; Oil Filler Cap .....	10099	
2008-2005; OE Equivalent Fuel Cap .....	10841		<b>4-Cyl. 2.4 L (Canada)</b>		
2008-2005; Regular Locking Fuel Cap .....	10511		2006; OE Type Radiator Cap .....	10248	15
2008-2005; Oil Filler Cap .....	10099		2006; OE Equivalent Fuel Cap .....	10841	
2004; OE Type Radiator Cap .....	10248	15	2006; Regular Locking Fuel Cap .....	10511	
2004; OE Equivalent Fuel Cap .....	10836		2006; Oil Filler Cap .....	10099	
2004; Regular Locking Fuel Cap .....	10506		<b>Solstice</b>		
2004; Oil Filler Cap .....	10099		<b>4-Cyl. 2.0 L</b>		
2003-1998; Lev-R-Vent Radiator Cap .....	10331	16	2010; OE Type Radiator Cap .....	10248	15
2003-1998; OE Type Radiator Cap .....	10231	16	2009-2007; OE Type Radiator Cap .....	10248	15
2003-1998; OE Equivalent Fuel Cap .....	10836		2009-2007; OE Equivalent Fuel Cap .....	10841	
2003-1998; Regular Locking Fuel Cap .....	10506		2009-2007; Regular Locking Fuel Cap .....	10523	
2003-1998; Oil Filler Cap .....	10099		2009-2007; Oil Filler Cap .....	10099	
1997; Lev-R-Vent Radiator Cap .....	10331	16	<b>4-Cyl. 2.4 L</b>		
1997; OE Type Radiator Cap .....	10231	16	2009-2008; OE Type Radiator Cap .....	10248	15
1997; Pre-Vent Non-Locking Fuel Cap .....	10819		2009-2008; OE Equivalent Fuel Cap .....	10841	
1997; Pre-Vent Locking Fuel Cap .....	10501		2009-2008; Regular Locking Fuel Cap .....	10523	
1997; Oil Filler Cap .....	10099		2009-2008; Oil Filler Cap .....	10099	
<b>V-8 5.3 L</b>			2007; OE Type Radiator Cap .....	10248	15
2008-2006; OE Type Radiator Cap .....	10248	15	2007; OE Equivalent Fuel Cap .....	10841	
2008-2006; OE Equivalent Fuel Cap .....	10841		2007; Regular Locking Fuel Cap .....	10511	
2008-2006; Regular Locking Fuel Cap .....	10511		2007; Oil Filler Cap .....	10099	
2008-2006; Oil Filler Cap .....	10099		2006; OE Type Radiator Cap .....	10248	15
2005; OE Equivalent Fuel Cap .....	10841		2006; OE Equivalent Fuel Cap .....	10841	
2005; Regular Locking Fuel Cap .....	10511		2006; Regular Locking Fuel Cap .....	10523	
<b>GTO</b>			2006; Oil Filler Cap .....	10099	
<b>V-8 5.7 L</b>			<b>Sunfire</b>		
2004; OE Type Radiator Cap .....	10239	15	<b>4-Cyl. 2.2 L</b>		
2004; OE Equivalent Fuel Cap .....	10841		2005-2003; OE Type Radiator Cap .....	10248	15
2004; Regular Locking Fuel Cap .....	10511				
2004; Oil Filler Cap .....	10099				

## Caps for Passenger Cars and Light Trucks (1990 and Newer)

Application	Part Number	PSI	Application	Part Number	PSI
<b>Pontiac - Continued</b>			<b>Pontiac - Continued</b>		
<b>Sunfire - Continued</b>			<b>Sunrunner - Continued</b>		
<b>4-Cyl. 2.2 L - Continued</b>			<b>4-Cyl. 1.6 L (Canada) - Continued</b>		
2005-2003: OE Equivalent Fuel Cap .....	10836		1995: Oil Filler Cap; Eng. VIN 6 .....	10101	
2005-2003: Regular Locking Fuel Cap .....	10506		1995: Oil Filler Cap; Eng. VIN U .....	10083	
2005-2003: Oil Filler Cap .....	10099		<b>Torrent</b>		
2002: OE Type Radiator Cap .....	10248	15	<b>V-6 3.4 L</b>		
2002: OE Equivalent Fuel Cap .....	10836		2009-2006: OE Type Radiator Cap .....	10248	15
2002: Regular Locking Fuel Cap .....	10506		2009-2006: OE Equivalent Fuel Cap .....	10841	
2002: Oil Filler Cap; Eng. VIN F .....	10099		2009-2006: Regular Locking Fuel Cap .....	10511	
2001-2000: OE Type Radiator Cap .....	10248	15	2009-2006: Oil Filler Cap .....	10099	
2001-2000: OE Equivalent Fuel Cap .....	10836		<b>V-6 3.6 L</b>		
2001-2000: Regular Locking Fuel Cap .....	10506		2009-2008: OE Type Radiator Cap .....	10248	15
2001-2000: Oil Filler Cap .....	10123		2009-2008: OE Equivalent Fuel Cap .....	10841	
1999: OE Type Radiator Cap .....	10248	15	2009-2008: Regular Locking Fuel Cap .....	10511	
1999: OE Equivalent Fuel Cap .....	10836		2009-2008: Oil Filler Cap .....	10099	
1999: Regular Locking Fuel Cap .....	10506		<b>Trans Sport</b>		
1999: Oil Filler Cap .....	10105		<b>V-6 3.1 L</b>		
1998-1997: OE Type Radiator Cap .....	10239	15	1995: Lev-R-Vent Radiator Cap .....	10331	16
1998-1997: OE Equivalent Fuel Cap .....	10836		1995: OE Type Radiator Cap .....	10231	16
1998-1997: Regular Locking Fuel Cap .....	10506		1995: OE Equivalent Fuel Cap .....	10817	
1998-1997: Oil Filler Cap .....	10122		1995: Pre-Vent Non-Locking Fuel Cap .....	10819	
1996-1995: OE Type Radiator Cap .....	10239	15	1995: Regular Locking Fuel Cap .....	10591	
1996-1995: OE Equivalent Fuel Cap .....	10834		1995: Pre-Vent Locking Fuel Cap .....	10501	
1996-1995: Regular Locking Fuel Cap .....	10504		1995: Oil Filler Cap .....	10072	
1996-1995: Oil Filler Cap .....	10122		<b>V-6 3.4 L</b>		
<b>4-Cyl. 2.3 L</b>			1998: Lev-R-Vent Radiator Cap .....	10331	16
1995: OE Type Radiator Cap .....	10239	15	1998: OE Type Radiator Cap .....	10231	16
1995: OE Equivalent Fuel Cap .....	10834		1998: OE Equivalent Fuel Cap .....	10836	
1995: Regular Locking Fuel Cap .....	10504		1998: Regular Locking Fuel Cap .....	10506	
1995: Oil Filler Cap .....	10132		1998: Oil Filler Cap .....	10099	
<b>4-Cyl. 2.4 L</b>			1997-1996: Lev-R-Vent Radiator Cap .....	10331	16
2002-1999: OE Type Radiator Cap .....	10248	15	1997-1996: OE Type Radiator Cap .....	10231	16
2002-1999: OE Equivalent Fuel Cap .....	10836		1997-1996: OE Equivalent Fuel Cap .....	10817	
2002-1999: Regular Locking Fuel Cap .....	10506		1997-1996: Pre-Vent Non-Locking Fuel Cap .....	10819	
2002-1999: Oil Filler Cap .....	10105		1997-1996: Regular Locking Fuel Cap .....	10591	
1998: OE Type Radiator Cap .....	10239	15	1997-1996: Pre-Vent Locking Fuel Cap .....	10501	
1998: OE Equivalent Fuel Cap .....	10836		1997-1996: Oil Filler Cap .....	10099	
1998: Regular Locking Fuel Cap .....	10506		<b>V-6 3.8 L</b>		
1998: Oil Filler Cap .....	10105		1995: Lev-R-Vent Radiator Cap .....	10331	16
1997: OE Type Radiator Cap .....	10239	15	1995: OE Type Radiator Cap .....	10231	16
1997: OE Equivalent Fuel Cap .....	10836		1995: OE Equivalent Fuel Cap .....	10817	
1997: Regular Locking Fuel Cap .....	10506		1995: Pre-Vent Non-Locking Fuel Cap .....	10819	
1997: Oil Filler Cap .....	10122		1995: Regular Locking Fuel Cap .....	10591	
1996: OE Type Radiator Cap .....	10239	15	1995: Pre-Vent Locking Fuel Cap .....	10501	
1996: OE Equivalent Fuel Cap .....	10834		1995: Oil Filler Cap .....	10099	
1996: Regular Locking Fuel Cap .....	10504		<b>Vibe</b>		
1996: Oil Filler Cap .....	10105		<b>4-Cyl. 1.8 L</b>		
<b>Sunrunner</b>			2010-2007: OE Type Radiator Cap .....	10241	13
<b>4-Cyl. 1.6 L (Canada)</b>			2010-2007: OE Equivalent Fuel Cap .....	10834	
1997: OE Type Radiator Cap .....	10242	16	2010-2007: Regular Locking Fuel Cap .....	10504	
1997: OE Equivalent Fuel Cap .....	10825		2010-2007: Oil Filler Cap .....	10080	
1997: Regular Locking Fuel Cap .....	10595		2006: OE Type Radiator Cap .....	10241	13
1997: Oil Filler Cap .....	10081		2006: OE Equivalent Fuel Cap .....	10834	
1996: OE Type Radiator Cap .....	10242	16	2006: Regular Locking Fuel Cap .....	10504	
1996: OE Equivalent Fuel Cap .....	10825		2006: Oil Filler Cap .....	10135	
1996: Regular Locking Fuel Cap .....	10595		2005: OE Type Radiator Cap .....	10241	13
1996: Oil Filler Cap .....	10101		2005: OE Equivalent Fuel Cap; Eng. VIN L .....	10834	
1995: OE Type Radiator Cap .....	10242	16	2005: Regular Locking Fuel Cap; Eng. VIN L .....	10504	
1995: OE Equivalent Fuel Cap .....	10825		2005: OE Equivalent Fuel Cap; Eng. VIN 8 .....	10839	
1995: Regular Locking Fuel Cap .....	10595		2005: Regular Locking Fuel Cap; Eng. VIN 8 .....	10509	
1995: Oil Filler Cap; Eng. VIN 6 .....	10101		2005: Oil Filler Cap; Eng. VIN L .....	10080	
1995: Oil Filler Cap; Eng. VIN U .....	10083		2005: Oil Filler Cap; Eng. VIN 8 .....	10088	
1997: OE Type Radiator Cap .....	10242	16	2004-2003: OE Type Radiator Cap .....	10241	13
1997: OE Equivalent Fuel Cap .....	10825		2004-2003: OE Equivalent Fuel Cap .....	10834	
1997: Regular Locking Fuel Cap .....	10595		2004-2003: Regular Locking Fuel Cap .....	10504	
1997: Oil Filler Cap .....	10081		2004-2003: Oil Filler Cap .....	10080	
1996: OE Type Radiator Cap .....	10242	16	<b>4-Cyl. 2.4 L</b>		
1996: OE Equivalent Fuel Cap .....	10825		2010-2009: OE Type Radiator Cap .....	10241	13
1996: Regular Locking Fuel Cap .....	10595		2010-2009: OE Equivalent Fuel Cap .....	10834	
1996: Oil Filler Cap .....	10101		2010-2009: Regular Locking Fuel Cap .....	10504	
1995: OE Type Radiator Cap .....	10242	16	2010-2009: Oil Filler Cap .....	10080	
1995: OE Equivalent Fuel Cap .....	10825				
1995: Regular Locking Fuel Cap .....	10595				



## Caps for Passenger Cars and Light Trucks (1990 and Newer)

Application	Part Number	PSI	Application	Part Number	PSI
<b>Pontiac - Continued</b>			<b>Porsche - Continued</b>		
<b>Wave</b>			<b>Cayenne - Continued</b>		
4-Cyl. 1.6 L (Canada)			V-8 4.5 L - Continued		
2005; OE Type Radiator Cap .....	10259	20	2004-2003; Regular Locking Fuel Cap .....	10596	
2005; OE Equivalent Fuel Cap .....	10841		V-8 4.8 L		
2005; Regular Locking Fuel Cap .....	10511		2010-2008; OE Type Radiator Cap .....	10249	22
<b>Porsche</b>			<b>Cayman</b>		
<b>911</b>			6-Cyl. 2.7 L		
6-Cyl. 3.4 L			2008-2007; OE Equivalent Fuel Cap .....		
2000-1999; OE Equivalent Fuel Cap .....	10826		2008-2007; Regular Locking Fuel Cap .....		
2000-1999; Regular Locking Fuel Cap .....	10596		6-Cyl. 3.4 L		
6-Cyl. 3.6 L			2008-2006; OE Equivalent Fuel Cap .....		
2010-2001; OE Equivalent Fuel Cap .....	10826		2008-2006; Regular Locking Fuel Cap .....		
2010-2001; Regular Locking Fuel Cap .....	10596		<b>Saab</b>		
1998; OE Equivalent Fuel Cap .....	10826		<b>9-3</b>		
1998; Regular Locking Fuel Cap .....	10596		4-Cyl. 2.0 L		
1997-1996; OE Equivalent Fuel Cap; W/O Turbo .....	10826		2009; Oil Filler Cap .....		
1997-1996; Regular Locking Fuel Cap; W/O Turbo .....	10596		2008; OE Equivalent Fuel Cap .....		
1995; OE Equivalent Fuel Cap .....	10826		2008; Regular Locking Fuel Cap .....		
1995; Regular Locking Fuel Cap .....	10596		2008; Oil Filler Cap .....		
6-Cyl. 3.8 L			2007-2004; OE Equivalent Fuel Cap .....		
2010-2005; OE Equivalent Fuel Cap .....	10826		2007-2004; Regular Locking Fuel Cap .....		
2010-2005; Regular Locking Fuel Cap .....	10596		2007-2004; Oil Filler Cap .....		
<b>928</b>			2003; OE Type Radiator Cap .....		
V-8 5.4 L			2003; OE Equivalent Fuel Cap; W/Threaded Filler Neck .....		
1995; Lev-R-Vent Radiator Cap .....	10329	13	2003; Regular Locking Fuel Cap; W/Threaded Filler Neck .....		
1995; OE Type Radiator Cap .....	10229	13	2003; Oil Filler Cap; Eng. VIN S, Y .....		
<b>968</b>			2002-1999; OE Type Radiator Cap .....		
4-Cyl. 3.0 L			2002-1999; OE Equivalent Fuel Cap .....		
1995; Lev-R-Vent Radiator Cap .....	10330	16	2002-1999; Regular Locking Fuel Cap .....		
1995; OE Type Radiator Cap .....	10230	16	2002-1999; Oil Filler Cap .....		
1995; OE Equivalent Fuel Cap .....	10826		4-Cyl. 2.3 L		
1995; Regular Locking Fuel Cap .....	10596		2002-2001; OE Type Radiator Cap .....		
<b>Boxster</b>			2002-2001; OE Equivalent Fuel Cap .....		
6-Cyl. 2.5 L			2002-2001; Regular Locking Fuel Cap .....		
1999; OE Equivalent Fuel Cap .....	10826		2000-1999; OE Type Radiator Cap .....		
1999; Regular Locking Fuel Cap .....	10596		2000-1999; OE Equivalent Fuel Cap .....		
1998-1997; OE Type Radiator Cap .....	10225	20	2000-1999; Regular Locking Fuel Cap .....		
1998-1997; OE Equivalent Fuel Cap .....	10826		V-6 2.8 L		
1998-1997; Regular Locking Fuel Cap .....	10596		2009; Oil Filler Cap .....		
6-Cyl. 2.7 L			2008; OE Equivalent Fuel Cap .....		
2007-2000; OE Equivalent Fuel Cap .....	10826		2008; Regular Locking Fuel Cap .....		
2007-2000; Regular Locking Fuel Cap .....	10596		2008; Oil Filler Cap .....		
6-Cyl. 3.2 L			2007-2006; OE Equivalent Fuel Cap .....		
2006-2000; OE Equivalent Fuel Cap .....	10826		2007-2006; Regular Locking Fuel Cap .....		
2006-2000; Regular Locking Fuel Cap .....	10596		2007-2006; Oil Filler Cap .....		
6-Cyl. 3.4 L			<b>9-5</b>		
2008-2007; OE Equivalent Fuel Cap .....	10826		4-Cyl. 2.3 L		
2008-2007; Regular Locking Fuel Cap .....	10596		2008-2007; OE Type Radiator Cap .....		
<b>Cayenne</b>			2008-2007; OE Equivalent Fuel Cap .....		
V-6 3.2 L			2008-2007; Regular Locking Fuel Cap .....		
2006; OE Type Radiator Cap .....	10249	22	2008-2007; Oil Filler Cap .....		
2006; OE Equivalent Fuel Cap .....	10826		2006; OE Type Radiator Cap .....		
2006; Regular Locking Fuel Cap .....	10596		2006; OE Equivalent Fuel Cap .....		
2006; Oil Filler Cap .....	10079		2006; Regular Locking Fuel Cap .....		
2005; OE Type Radiator Cap .....	10249	22	2006; Oil Filler Cap .....		
2004; OE Type Radiator Cap .....	10249	22	2005-1999; OE Type Radiator Cap .....		
2004; OE Equivalent Fuel Cap .....	10826		2005-1999; OE Equivalent Fuel Cap .....		
2004; Regular Locking Fuel Cap .....	10596		2005-1999; Regular Locking Fuel Cap .....		
V-6 3.6 L			2005-1999; Oil Filler Cap .....		
2010-2009; OE Type Radiator Cap .....	10249	22	V-6 3.0 L		
V-8 4.5 L			2003-1999; OE Type Radiator Cap .....		
2006; OE Type Radiator Cap .....	10249	22	2003-1999; OE Equivalent Fuel Cap .....		
2006; OE Equivalent Fuel Cap .....	10826		2003-1999; Regular Locking Fuel Cap .....		
2006; Regular Locking Fuel Cap .....	10596		<b>9-7X</b>		
2005; OE Type Radiator Cap .....	10249	22	6-Cyl. 4.2 L; V-8 5.3 L		
2004-2003; OE Type Radiator Cap .....	10249	22	2009-2005; OE Type Radiator Cap .....		
2004-2003; OE Equivalent Fuel Cap .....	10826		2009-2005; OE Equivalent Fuel Cap .....		
			2009-2005; Regular Locking Fuel Cap .....		
			2009-2005; Oil Filler Cap .....		

## Caps for Passenger Cars and Light Trucks (1990 and Newer)

Application	Part Number	PSI	Application	Part Number	PSI
<b>Saab - Continued</b>			<b>Saturn - Continued</b>		
<b>9-7X - Continued</b>			<b>Ion - Continued</b>		
<b>V-8 6.0 L</b>			<b>4-Cyl. 2.0 L - Continued</b>		
2009-2008; OE Type Radiator Cap .....	10248	15	2005-2004; OE Type Radiator Cap .....	10248	15
2009-2008; OE Equivalent Fuel Cap .....	10841		2005-2004; OE Equivalent Fuel Cap .....	10836	
2009-2008; Regular Locking Fuel Cap .....	10511		2005-2004; Regular Locking Fuel Cap .....	10506	
2009-2008; Oil Filler Cap .....	10099		2005-2004; Oil Filler Cap .....	10099	
<b>900</b>			<b>4-Cyl. 2.2 L</b>		
<b>4-Cyl. 2.0 L; 4-Cyl. 2.3 L</b>			2007-2006; OE Type Radiator Cap .....		
1998-1996; OE Type Radiator Cap .....	10259	20	2007-2006; OE Equivalent Fuel Cap .....	10841	15
1998-1996; OE Equivalent Fuel Cap .....	10834		2007-2006; Regular Locking Fuel Cap .....	10511	
1998-1996; Regular Locking Fuel Cap .....	10504		2007-2006; Oil Filler Cap .....	10099	
1995; OE Type Radiator Cap .....	10259	20	2005-2003; OE Type Radiator Cap .....	10248	15
1995; OE Equivalent Fuel Cap; Exc. Convertible .....	10826		2005-2003; OE Equivalent Fuel Cap .....	10836	
1995; Regular Locking Fuel Cap; Exc. Convertible .....	10596		2005-2003; Regular Locking Fuel Cap .....	10506	
<b>V-6 2.5 L</b>			2005-2003; Oil Filler Cap .....		
1997-1996; OE Type Radiator Cap .....	10259	20	<b>4-Cyl. 2.4 L</b>		
1997-1996; OE Equivalent Fuel Cap .....	10834		2007; OE Type Radiator Cap .....	10248	15
1997-1996; Regular Locking Fuel Cap .....	10504		2007; OE Equivalent Fuel Cap .....	10841	
1995; OE Type Radiator Cap .....	10259	20	2007; Regular Locking Fuel Cap .....	10511	
1995; OE Equivalent Fuel Cap; Exc. Convertible .....	10826		2007; Oil Filler Cap .....	10099	
1995; Regular Locking Fuel Cap; Exc. Convertible .....	10596		2006; OE Type Radiator Cap .....	10248	15
<b>9000</b>			2006; OE Equivalent Fuel Cap .....	10836	
<b>4-Cyl. 2.3 L</b>			2006; Regular Locking Fuel Cap .....	10506	
1998-1995; OE Type Radiator Cap .....	10260	15	2006; Oil Filler Cap .....	10099	
1998-1995; OE Equivalent Fuel Cap .....	10826		<b>L-Series</b>		
1998-1995; Regular Locking Fuel Cap .....	10596		<b>4-Cyl. 2.2 L</b>		
<b>V-6 3.0 L</b>			2004-2000; OE Type Radiator Cap .....		
1997-1995; OE Type Radiator Cap .....	10260	15	2004-2000; OE Equivalent Fuel Cap .....	10836	20
1997-1995; OE Equivalent Fuel Cap .....	10826		2004-2000; Regular Locking Fuel Cap .....	10506	
1997-1995; Regular Locking Fuel Cap .....	10596		2004-2000; Oil Filler Cap .....	10099	
<b>Saturn</b>			<b>V-6 3.0 L</b>		
<b>Astra</b>			2005-2000; OE Type Radiator Cap .....		
<b>4-Cyl. 1.8 L</b>			2005-2000; OE Equivalent Fuel Cap .....	10836	20
2008; OE Equivalent Fuel Cap .....	10841		2005-2000; Regular Locking Fuel Cap .....	10506	
2008; Regular Locking Fuel Cap .....	10511		2005-2000; Oil Filler Cap .....	10140	
<b>Aura</b>			<b>Outlook</b>		
<b>4-Cyl. 2.4 L</b>			<b>V-6 3.6 L</b>		
2009; OE Type Radiator Cap .....	10248	15	2009-2007; OE Type Radiator Cap .....		
2009; Oil Filler Cap .....	10099		2009-2007; OE Equivalent Fuel Cap .....	10841	15
2008; OE Type Radiator Cap .....	10248	15	2009-2007; Regular Locking Fuel Cap .....	10511	
2008; OE Equivalent Fuel Cap .....	10841		2009-2007; Oil Filler Cap .....	10099	
2008; Regular Locking Fuel Cap .....	10511		<b>Relay</b>		
2008; Oil Filler Cap .....	10099		<b>V-6 3.5 L</b>		
<b>4-Cyl. 2.4 L Electric Assist</b>			2006; Lev-R-Vent Radiator Cap .....		
2009; OE Type Radiator Cap .....	10248	15	2006; OE Type Radiator Cap .....	10331	16
2009; Oil Filler Cap .....	10099		2006; OE Equivalent Fuel Cap .....	10841	16
2008; OE Type Radiator Cap .....	10248	15	2006; Regular Locking Fuel Cap .....	10511	
2008; OE Equivalent Fuel Cap .....	10841		2006; Oil Filler Cap .....	10099	
2008; Regular Locking Fuel Cap .....	10511		2005; Lev-R-Vent Radiator Cap .....	10331	16
2008; Oil Filler Cap .....	10099		2005; OE Type Radiator Cap .....	10231	16
2007; OE Equivalent Fuel Cap .....	10841		2005; Coolant Recovery Tank Cap .....	10236	
2007; Regular Locking Fuel Cap .....	10511		2005; OE Equivalent Fuel Cap .....	10841	
<b>V-6 3.5 L</b>			2005; Regular Locking Fuel Cap .....	10511	
2008-2007; OE Type Radiator Cap .....	10248	15	2005; Oil Filler Cap .....	10099	
2008-2007; OE Equivalent Fuel Cap .....	10841		<b>V-6 3.9 L</b>		
2008-2007; Regular Locking Fuel Cap .....	10511		2007; OE Equivalent Fuel Cap .....		
2008-2007; Oil Filler Cap .....	10099		2007; Regular Locking Fuel Cap .....	10511	
<b>V-6 3.6 L</b>			2007; Oil Filler Cap .....	10099	
2009-2007; OE Type Radiator Cap .....	10248	15	2006; OE Type Radiator Cap .....	10248	15
2009-2007; OE Equivalent Fuel Cap .....	10841		2006; OE Equivalent Fuel Cap .....	10841	
2009-2007; Regular Locking Fuel Cap .....	10511		2006; Regular Locking Fuel Cap .....	10511	
2009-2007; Oil Filler Cap .....	10099		2006; Oil Filler Cap .....	10099	
<b>Ion</b>			<b>S-Series</b>		
<b>4-Cyl. 2.0 L</b>			<b>4-Cyl. 1.9 L</b>		
2007-2006; OE Type Radiator Cap .....	10248	15	2002-1998; OE Type Radiator Cap .....		
2007-2006; OE Equivalent Fuel Cap .....	10841		2002-1998; OE Equivalent Fuel Cap .....	10836	15
2007-2006; Regular Locking Fuel Cap .....	10511		2002-1998; Regular Locking Fuel Cap .....	10506	
2007-2006; Oil Filler Cap .....	10099		2002-1998; Oil Filler Cap .....	10099	
			1997-1995; OE Type Radiator Cap .....		
			1997-1995; Pre-Vent Non-Locking Fuel Cap .....		
			10239		
			10819		

## Caps for Passenger Cars and Light Trucks (1990 and Newer)

Application	Part Number	PSI	Application	Part Number	PSI
<b>Saturn - Continued</b>			<b>Scion - Continued</b>		
<b>S-Series - Continued</b>			<b>TC - Continued</b>		
<b>4-Cyl. 1.9 L - Continued</b>			<b>4-Cyl. 2.4 L - Continued</b>		
1997-1995; Pre-Vent Locking Fuel Cap .....	10501		2010-2005; Oil Filler Cap .....	10135	
1997-1995; Oil Filler Cap .....	10099		<b>4-Cyl. 2.5 L</b>		
<b>Sky</b>			2012-2011; OE Type Radiator Cap .....	10254	19
<b>4-Cyl. 2.0 L; 4-Cyl. 2.4 L</b>			2012-2011; OE Equivalent Fuel Cap .....	10834	
2010; OE Equivalent Fuel Cap .....	10841		2012-2011; Regular Locking Fuel Cap .....	10504	
2010; Regular Locking Fuel Cap .....	10511		<b>XA</b>		
2009-2007; OE Type Radiator Cap .....	10248	15	<b>4-Cyl. 1.5 L</b>		
2009-2007; OE Equivalent Fuel Cap .....	10841		2006-2005; OE Type Radiator Cap .....	10242	16
2009-2007; Regular Locking Fuel Cap .....	10511		2006-2005; OE Equivalent Fuel Cap .....	10834	
2009-2007; Oil Filler Cap .....	10099		2006-2005; Regular Locking Fuel Cap .....	10504	
<b>VUE</b>			2006-2005; Oil Filler Cap .....	10135	
<b>4-Cyl. 2.2 L</b>			2004; OE Type Radiator Cap .....	10242	16
2007-2004; OE Type Radiator Cap .....	10248	15	2004; OE Equivalent Fuel Cap .....	10834	
2007-2004; OE Equivalent Fuel Cap .....	10841		2004; Regular Locking Fuel Cap .....	10504	
2007-2004; Regular Locking Fuel Cap .....	10511		2004; Oil Filler Cap .....	10080	
2007-2004; Oil Filler Cap .....	10099		<b>XB</b>		
2003; OE Type Radiator Cap .....	10248	15	<b>4-Cyl. 1.5 L</b>		
2003; OE Equivalent Fuel Cap .....	10836		2006; OE Type Radiator Cap .....	10242	16
2003; Regular Locking Fuel Cap .....	10506		2006; OE Equivalent Fuel Cap .....	10834	
2003; Oil Filler Cap .....	10099		2006; Regular Locking Fuel Cap .....	10504	
2002; OE Type Radiator Cap .....	10259	20	2005; OE Type Radiator Cap .....	10242	16
2002; OE Equivalent Fuel Cap .....	10836		2005; OE Equivalent Fuel Cap .....	10834	
2002; Regular Locking Fuel Cap .....	10506		2005; Regular Locking Fuel Cap .....	10504	
2002; Oil Filler Cap .....	10099		2005; Oil Filler Cap .....	10135	
<b>4-Cyl. 2.4 L</b>			2004; OE Type Radiator Cap .....	10242	16
2009; OE Type Radiator Cap .....	10248	15	2004; OE Equivalent Fuel Cap .....	10834	
2009; Oil Filler Cap .....	10099		2004; Regular Locking Fuel Cap .....	10504	
2008; OE Type Radiator Cap .....	10248	15	2004; Oil Filler Cap .....	10080	
2008; OE Equivalent Fuel Cap .....	10841		<b>4-Cyl. 2.4 L</b>		
2008; Regular Locking Fuel Cap .....	10511		2012; OE Equivalent Fuel Cap .....	10834	
2008; Oil Filler Cap .....	10099		2012; Regular Locking Fuel Cap .....	10504	
<b>4-Cyl. 2.4 L Electric Assist</b>			2011; OE Type Radiator Cap .....	10254	19
2009-2007; OE Type Radiator Cap .....	10248	15	2011; OE Equivalent Fuel Cap .....	10834	
2009-2007; OE Equivalent Fuel Cap .....	10841		2011; Regular Locking Fuel Cap .....	10504	
2009-2007; Regular Locking Fuel Cap .....	10511		2010-2008; OE Type Radiator Cap .....	10254	19
2009-2007; Oil Filler Cap .....	10099		2010-2008; OE Equivalent Fuel Cap .....	10834	
<b>V-6 3.0 L</b>			2010-2008; Regular Locking Fuel Cap .....	10504	
2003; OE Type Radiator Cap .....	10248	15	2010-2008; Oil Filler Cap .....	10135	
2003; OE Equivalent Fuel Cap .....	10841		<b>XD</b>		
2003; Regular Locking Fuel Cap .....	10511		<b>4-Cyl. 1.8 L</b>		
2003; Oil Filler Cap .....	10140		2011-2008; OE Type Radiator Cap .....	10242	16
2002; OE Type Radiator Cap .....	10259	20	2011-2008; OE Equivalent Fuel Cap .....	10834	
2002; OE Equivalent Fuel Cap .....	10836		2011-2008; Regular Locking Fuel Cap .....	10504	
2002; Regular Locking Fuel Cap .....	10506		2011-2008; Oil Filler Cap .....	10135	
2002; Oil Filler Cap .....	10140		<b>Subaru</b>		
<b>V-6 3.5 L</b>			<b>B9 Tribeca</b>		
2009-2008; OE Type Radiator Cap .....	10248	15	<b>6-Cyl. 3.0 L</b>		
2009-2008; OE Equivalent Fuel Cap .....	10841		2007-2006; OE Type Radiator Cap .....	10241	13
2009-2008; Regular Locking Fuel Cap .....	10511		2007-2006; OE Equivalent Fuel Cap .....	10838	
2009-2008; Oil Filler Cap .....	10099		2007-2006; Regular Locking Fuel Cap .....	10508	
2007-2004; OE Type Radiator Cap .....	10248	15	2007-2006; Oil Filler Cap .....	10110	
2007-2004; OE Equivalent Fuel Cap .....	10841		<b>Baja</b>		
2007-2004; Regular Locking Fuel Cap .....	10511		<b>4-Cyl. 2.5 L</b>		
2007-2004; Oil Filler Cap .....	10081		2006; Lev-R-Vent Radiator Cap .....	✓10333	16
<b>V-6 3.6 L</b>			2006; OE Type Radiator Cap .....	10233	16
2009-2008; OE Type Radiator Cap .....	10248	15	2006; OE Equivalent Fuel Cap .....	10834	
2009-2008; OE Equivalent Fuel Cap .....	10841		2006; Regular Locking Fuel Cap .....	10504	
2009-2008; Regular Locking Fuel Cap .....	10511		2006; Oil Filler Cap .....	10110	
2009-2008; Oil Filler Cap .....	10099		2005; Lev-R-Vent Radiator Cap; Radiator cap located on Eng. ...	✓10333	16
<b>V-6 3.6 L Electric Assist</b>			2005; OE Type Radiator Cap; Radiator cap located on Eng. ....	10233	16
2009; OE Type Radiator Cap .....	10248	15	2005; OE Equivalent Fuel Cap .....	10834	
<b>Scion</b>			2005; Regular Locking Fuel Cap .....	10504	
<b>TC</b>			2005; Oil Filler Cap .....	10110	
<b>4-Cyl. 2.4 L</b>			2004-2003; Lev-R-Vent Radiator Cap .....	✓10333	16
2010-2005; OE Type Radiator Cap .....	10241	13	2004-2003; OE Type Radiator Cap .....	10233	16
2010-2005; OE Equivalent Fuel Cap .....	10839		2004-2003; OE Equivalent Fuel Cap .....	10834	
2010-2005; Regular Locking Fuel Cap .....	10509		2004-2003; Regular Locking Fuel Cap .....	10504	

✓ Check Hood Clearance prior to installing this Cap.

## Caps for Passenger Cars and Light Trucks (1990 and Newer)

Application	Part Number	PSI	Application	Part Number	PSI
<b>Subaru - Continued</b>			<b>Subaru - Continued</b>		
<b>Baja - Continued</b>			<b>Impreza - Continued</b>		
<b>4-Cyl. 2.5 L - Continued</b>			<b>4-Cyl. 2.2 L - Continued</b>		
2004-2003; Oil Filler Cap .....	10110		1998-1995; OE Type Radiator Cap .....	10227	13
<b>Forester</b>			1998-1995; OE Equivalent Fuel Cap .....	10817	
<b>4-Cyl. 2.5 L</b>			1998-1995; Pre-Vent Non-Locking Fuel Cap .....	10819	
2011; OE Type Radiator Cap .....	10233	16	1998-1995; Regular Locking Fuel Cap .....	10591	
2011; Lev-R-Vent Radiator Cap .....	10333	16	1998-1995; Pre-Vent Locking Fuel Cap .....	10501	
2011; OE Equivalent Fuel Cap .....	10838		1998-1995; Oil Filler Cap .....	10110	
2011; Regular Locking Fuel Cap .....	10508		<b>4-Cyl. 2.5 L</b>		
2010; Lev-R-Vent Radiator Cap .....	10333	16	2011; OE Type Radiator Cap .....	10233	16
2010; OE Type Radiator Cap .....	10233	16	2011; Lev-R-Vent Radiator Cap .....	10333	16
2010; OE Equivalent Fuel Cap .....	10838		2011; OE Equivalent Fuel Cap .....	10838	
2010; Regular Locking Fuel Cap .....	10508		2011; Regular Locking Fuel Cap .....	10508	
2010; Oil Filler Cap .....	10110		2010; Lev-R-Vent Radiator Cap .....	10333	16
2009; Lev-R-Vent Radiator Cap .....	✓10333	16	2010; OE Type Radiator Cap .....	10233	16
2009; OE Type Radiator Cap .....	10233	16	2010; OE Equivalent Fuel Cap .....	10838	
2009; OE Equivalent Fuel Cap .....	10838		2010; Regular Locking Fuel Cap .....	10508	
2009; Regular Locking Fuel Cap .....	10508		2010; Oil Filler Cap .....	10110	
2009; Oil Filler Cap .....	10110		2009; Lev-R-Vent Radiator Cap .....	✓10333	16
2008-2001; Lev-R-Vent Radiator Cap .....	✓10333	16	2009; OE Type Radiator Cap .....	10233	16
2008-2001; OE Type Radiator Cap .....	10233	16	2009; OE Equivalent Fuel Cap .....	10838	
2008-2001; OE Equivalent Fuel Cap .....	10834		2009; Regular Locking Fuel Cap .....	10508	
2008-2001; Regular Locking Fuel Cap .....	10504		2009; Oil Filler Cap .....	10110	
2008-2001; Oil Filler Cap .....	10110		2008-2001; Lev-R-Vent Radiator Cap .....	✓10333	16
2000-1999; Lev-R-Vent Radiator Cap .....	✓10333	16	2008-2001; OE Type Radiator Cap .....	10233	16
2000-1999; OE Type Radiator Cap .....	10233	16	2008-2001; OE Equivalent Fuel Cap .....	10834	
2000-1999; OE Equivalent Fuel Cap .....	10817		2008-2001; Regular Locking Fuel Cap .....	10504	
2000-1999; Pre-Vent Non-Locking Fuel Cap .....	10819		2008-2001; Oil Filler Cap .....	10110	
2000-1999; Regular Locking Fuel Cap .....	10591		2000-1999; Lev-R-Vent Radiator Cap .....	✓10333	16
2000-1999; Pre-Vent Locking Fuel Cap .....	10501		2000-1999; OE Type Radiator Cap .....	10233	16
2000-1999; Oil Filler Cap .....	10110		2000-1999; OE Equivalent Fuel Cap .....	10817	
1998; Lev-R-Vent Radiator Cap .....	✓10327	13	2000-1999; Pre-Vent Non-Locking Fuel Cap .....	10819	
1998; OE Type Radiator Cap .....	10227	13	2000-1999; Regular Locking Fuel Cap .....	10591	
1998; OE Equivalent Fuel Cap .....	10817		2000-1999; Pre-Vent Locking Fuel Cap .....	10501	
1998; Pre-Vent Non-Locking Fuel Cap .....	10819		2000-1999; Oil Filler Cap .....	10110	
1998; Regular Locking Fuel Cap .....	10591		1998; Lev-R-Vent Radiator Cap .....	✓10327	13
1998; Pre-Vent Locking Fuel Cap .....	10501		1998; OE Type Radiator Cap .....	10227	13
1998; Oil Filler Cap .....	10110		1998; OE Equivalent Fuel Cap .....	10817	
<b>Impreza</b>			1998; Pre-Vent Non-Locking Fuel Cap .....	10819	
<b>4-Cyl. 1.8 L</b>			1998; Regular Locking Fuel Cap .....	10591	
1997-1995; Lev-R-Vent Radiator Cap .....	✓10327	13	1998; Pre-Vent Locking Fuel Cap .....	10501	
1997-1995; OE Type Radiator Cap .....	10227	13	1998; Oil Filler Cap .....	10110	
1997-1995; OE Equivalent Fuel Cap .....	10817		<b>Justy</b>		
1997-1995; Pre-Vent Non-Locking Fuel Cap .....	10819		<b>3-Cyl. 1.2 L (Canada)</b>		
1997-1995; Regular Locking Fuel Cap .....	10591		1995; Lev-R-Vent Radiator Cap .....	✓10327	13
1997-1995; Pre-Vent Locking Fuel Cap .....	10501		1995; OE Type Radiator Cap .....	10227	13
1997-1995; Oil Filler Cap .....	10110		1995; OE Equivalent Fuel Cap .....	10825	
<b>4-Cyl. 2.0 L</b>			1995; Regular Locking Fuel Cap .....	10595	
2005; Lev-R-Vent Radiator Cap; Radiator cap located on Eng. ...	✓10333	16	1995; Oil Filler Cap .....	10110	
2005; OE Type Radiator Cap; Radiator cap located on Eng. ....	10233	16	<b>Legacy</b>		
2005; OE Equivalent Fuel Cap .....	10834		<b>4-Cyl. 2.2 L</b>		
2005; Regular Locking Fuel Cap .....	10504		1999-1995; Lev-R-Vent Radiator Cap .....	✓10327	13
2005; Oil Filler Cap .....	10110		1999-1995; OE Type Radiator Cap .....	10227	13
2004-2002; Lev-R-Vent Radiator Cap .....	✓10333	16	1999-1995; OE Equivalent Fuel Cap .....	10817	
2004-2002; OE Type Radiator Cap .....	10233	16	1999-1995; Pre-Vent Non-Locking Fuel Cap .....	10819	
2004-2002; OE Equivalent Fuel Cap .....	10834		1999-1995; Regular Locking Fuel Cap .....	10591	
2004-2002; Regular Locking Fuel Cap .....	10504		1999-1995; Pre-Vent Locking Fuel Cap .....	10501	
2004-2002; Oil Filler Cap .....	10110		1999-1995; Oil Filler Cap .....	10110	
<b>4-Cyl. 2.2 L</b>			<b>4-Cyl. 2.5 L</b>		
2001; Lev-R-Vent Radiator Cap .....	✓10333	16	2011; Lev-R-Vent Radiator Cap .....	10333	16
2001; OE Type Radiator Cap .....	10233	16	2011; OE Type Radiator Cap .....	10233	16
2001; OE Equivalent Fuel Cap .....	10834		2011; OE Equivalent Fuel Cap .....	10834	
2001; Regular Locking Fuel Cap .....	10504		2011; Regular Locking Fuel Cap .....	10504	
2001; Oil Filler Cap .....	10110		2010; Lev-R-Vent Radiator Cap .....	10333	16
2000-1999; Lev-R-Vent Radiator Cap .....	✓10333	16	2010; OE Type Radiator Cap .....	10233	16
2000-1999; OE Type Radiator Cap .....	10233	16	2010; OE Equivalent Fuel Cap .....	10834	
2000-1999; OE Equivalent Fuel Cap .....	10817		2010; Regular Locking Fuel Cap .....	10504	
2000-1999; Pre-Vent Non-Locking Fuel Cap .....	10819		2010; Oil Filler Cap .....	10110	
2000-1999; Regular Locking Fuel Cap .....	10591		2009-2006; Lev-R-Vent Radiator Cap .....	✓10333	16
2000-1999; Pre-Vent Locking Fuel Cap .....	10501		2009-2006; OE Type Radiator Cap .....	10233	16
2000-1999; Oil Filler Cap .....	10110		2009-2006; OE Equivalent Fuel Cap .....	10838	
1998-1995; Lev-R-Vent Radiator Cap .....	✓10327	13	2009-2006; Regular Locking Fuel Cap .....	10508	

✓ Check Hood Clearance prior to installing this Cap.

## Caps for Passenger Cars and Light Trucks (1990 and Newer)

Application	Part Number	PSI	Application	Part Number	PSI
<b>Subaru - Continued</b>			<b>Subaru - Continued</b>		
<b>Legacy - Continued</b>			<b>Outback - Continued</b>		
<b>4-Cyl. 2.5 L - Continued</b>			<b>6-Cyl. 3.0 L</b>		
2009-2006; Oil Filler Cap .....	10110		2009-2005; OE Type Radiator Cap .....	10242	16
2005; Lev-R-Vent Radiator Cap; Radiator cap located on Eng. ...	✓10333	16	2009-2005; OE Equivalent Fuel Cap .....	10838	
2005; OE Type Radiator Cap; Radiator cap located on Eng. ....	10233	16	2009-2005; Regular Locking Fuel Cap .....	10508	
2005; OE Equivalent Fuel Cap .....	10838		2009-2005; Oil Filler Cap .....	10110	
2005; Regular Locking Fuel Cap .....	10508		2004-2001; OE Type Radiator Cap .....	10242	16
2005; Oil Filler Cap .....	10110		2004-2001; OE Equivalent Fuel Cap .....	10834	
2004-2001; Lev-R-Vent Radiator Cap .....	✓10333	16	2004-2001; Regular Locking Fuel Cap .....	10504	
2004-2001; OE Type Radiator Cap .....	10233	16	2004-2001; Oil Filler Cap .....	10110	
2004-2001; OE Equivalent Fuel Cap .....	10834		<b>6-Cyl. 3.6 L</b>		
2004-2001; Regular Locking Fuel Cap .....	10504		2011; OE Type Radiator Cap .....	10242	16
2004-2001; Oil Filler Cap .....	10110		2011; OE Equivalent Fuel Cap .....	10834	
2000; Lev-R-Vent Radiator Cap .....	✓10333	16	2011; Regular Locking Fuel Cap .....	10504	
2000; OE Type Radiator Cap .....	10233	16	2010; OE Type Radiator Cap .....	10242	16
2000; OE Equivalent Fuel Cap .....	10817		2010; OE Equivalent Fuel Cap .....	10834	
2000; Pre-Vent Non-Locking Fuel Cap .....	10819		2010; Regular Locking Fuel Cap .....	10504	
2000; Regular Locking Fuel Cap .....	10591		2010; Oil Filler Cap .....	10110	
2000; Pre-Vent Locking Fuel Cap .....	10501		<b>SVX</b>		
2000; Oil Filler Cap .....	10110		<b>6-Cyl. 3.3 L</b>		
1999-1996; Lev-R-Vent Radiator Cap .....	✓10327	13	1997-1995; Lev-R-Vent Radiator Cap .....	✓10327	13
1999-1996; OE Type Radiator Cap .....	10227	13	1997-1995; OE Type Radiator Cap .....	10227	13
1999-1996; OE Equivalent Fuel Cap .....	10817		1997-1995; OE Equivalent Fuel Cap .....	10817	
1999-1996; Pre-Vent Non-Locking Fuel Cap .....	10819		1997-1995; Pre-Vent Non-Locking Fuel Cap .....	10819	
1999-1996; Regular Locking Fuel Cap .....	10591		1997-1995; Regular Locking Fuel Cap .....	10591	
1999-1996; Pre-Vent Locking Fuel Cap .....	10501		1997-1995; Pre-Vent Locking Fuel Cap .....	10501	
1999-1996; Oil Filler Cap .....	10110		1997-1995; Oil Filler Cap .....	10110	
<b>6-Cyl. 3.0 L</b>			<b>Tribeca</b>		
2009-2008; OE Type Radiator Cap .....	10242	16	<b>6-Cyl. 3.6 L</b>		
2009-2008; OE Equivalent Fuel Cap .....	10838		2011; OE Equivalent Fuel Cap .....	10838	
2009-2008; Regular Locking Fuel Cap .....	10508		2011; Regular Locking Fuel Cap .....	10508	
2009-2008; Oil Filler Cap .....	10110		2010; OE Type Radiator Cap .....	10241	13
<b>6-Cyl. 3.6 L</b>			2010; Oil Filler Cap .....	10110	
2011; OE Type Radiator Cap .....	10242	16	2009-2008; OE Type Radiator Cap .....	10241	13
2011; OE Equivalent Fuel Cap .....	10834		2009-2008; OE Equivalent Fuel Cap .....	10838	
2011; Regular Locking Fuel Cap .....	10504		2009-2008; Regular Locking Fuel Cap .....	10508	
2010; OE Type Radiator Cap .....	10242	16	2009-2008; Oil Filler Cap .....	10110	
2010; OE Equivalent Fuel Cap .....	10834		<b>Suzuki</b>		
2010; Regular Locking Fuel Cap .....	10504		<b>Aerio</b>		
2010; Oil Filler Cap .....	10110		<b>4-Cyl. 2.0 L</b>		
<b>Outback</b>			2003-2002; OE Type Radiator Cap .....		
<b>4-Cyl. 2.5 L</b>			2003-2002; OE Equivalent Fuel Cap .....	10242	16
2011; Lev-R-Vent Radiator Cap .....	10333	16	2003-2002; Regular Locking Fuel Cap .....	10825	
2011; OE Type Radiator Cap .....	10233	16	2003-2002; Regular Locking Fuel Cap .....	10595	
2011; OE Equivalent Fuel Cap .....	10834		2003-2002; Oil Filler Cap .....	10081	
2011; Regular Locking Fuel Cap .....	10504		<b>4-Cyl. 2.3 L</b>		
2010; Lev-R-Vent Radiator Cap .....	10333	16	2007-2005; OE Type Radiator Cap .....	10242	16
2010; OE Type Radiator Cap .....	10233	16	2007-2005; OE Equivalent Fuel Cap .....	10834	
2010; OE Equivalent Fuel Cap .....	10834		2007-2005; Regular Locking Fuel Cap .....	10504	
2010; Regular Locking Fuel Cap .....	10504		2007-2005; Oil Filler Cap .....	10134	
2010; Oil Filler Cap .....	10110		2004; OE Type Radiator Cap .....	10242	16
2009-2006; Lev-R-Vent Radiator Cap .....	✓10333	16	2004; OE Equivalent Fuel Cap .....	10834	
2009-2006; OE Type Radiator Cap .....	10233	16	2004; Regular Locking Fuel Cap .....	10504	
2009-2006; OE Equivalent Fuel Cap .....	10838		2004; Oil Filler Cap .....	10081	
2009-2006; Regular Locking Fuel Cap .....	10508		<b>Esteem</b>		
2009-2006; Oil Filler Cap .....	10110		<b>4-Cyl. 1.6 L</b>		
2005; Lev-R-Vent Radiator Cap; Radiator cap located on Eng. ...	✓10333	16	2000; OE Type Radiator Cap .....	10242	16
2005; OE Type Radiator Cap; Radiator cap located on Eng. ....	10233	16	2000; OE Equivalent Fuel Cap .....	10825	
2005; OE Equivalent Fuel Cap .....	10838		2000; Regular Locking Fuel Cap .....	10595	
2005; Regular Locking Fuel Cap .....	10508		1999-1995; OE Type Radiator Cap .....	10242	16
2005; Oil Filler Cap .....	10110		1999-1995; OE Equivalent Fuel Cap .....	10825	
2004-2001; Lev-R-Vent Radiator Cap .....	✓10333	16	1999-1995; Regular Locking Fuel Cap .....	10595	
2004-2001; OE Type Radiator Cap .....	10233	16	1999-1995; Oil Filler Cap .....	10081	
2004-2001; OE Equivalent Fuel Cap .....	10834		<b>4-Cyl. 1.6 L (Canada)</b>		
2004-2001; Regular Locking Fuel Cap .....	10504		2001; OE Equivalent Fuel Cap .....	10825	
2004-2001; Oil Filler Cap .....	10110		2001; Regular Locking Fuel Cap .....	10595	
2000; Lev-R-Vent Radiator Cap .....	✓10333	16	<b>4-Cyl. 1.8 L</b>		
2000; OE Type Radiator Cap .....	10233	16	2002-2001; OE Type Radiator Cap; Sedan .....	10241	13
2000; OE Equivalent Fuel Cap .....	10817		2002-2001; OE Type Radiator Cap; Wagon .....	10242	16
2000; Pre-Vent Non-Locking Fuel Cap .....	10819		2002-2001; OE Equivalent Fuel Cap .....	10825	
2000; Regular Locking Fuel Cap .....	10591				
2000; Pre-Vent Locking Fuel Cap .....	10501				
2000; Oil Filler Cap .....	10110				

✓ Check Hood Clearance prior to installing this Cap.

## Caps for Passenger Cars and Light Trucks (1990 and Newer)

Application	Part Number	PSI	Application	Part Number	PSI
<b>Suzuki - Continued</b>			<b>Suzuki - Continued</b>		
<b>Esteem - Continued</b>			<b>Sidekick - Continued</b>		
<b>4-Cyl. 1.8 L - Continued</b>			<b>4-Cyl. 1.6 L - Continued</b>		
2002-2001; Regular Locking Fuel Cap .....	10595		1998-1996; Regular Locking Fuel Cap .....	10595	
2002-2001; Oil Filler Cap .....	10081		1998-1996; Oil Filler Cap .....	10081	
2000-1999; OE Type Radiator Cap .....	10242	16	1995; OE Type Radiator Cap .....	10242	16
2000-1999; OE Equivalent Fuel Cap .....	10825		1995; OE Equivalent Fuel Cap .....	10825	
2000-1999; Regular Locking Fuel Cap .....	10595		1995; Regular Locking Fuel Cap .....	10595	
2000-1999; Oil Filler Cap .....	10081		1995; Oil Filler Cap; W/8-Valve Eng. ....	10083	
			1995; Oil Filler Cap; W/16-Valve Eng. ....	10081	
<b>Forenza</b>			<b>4-Cyl. 1.8 L</b>		
2008-2004; OE Equivalent Fuel Cap .....	10841		1998-1996; OE Type Radiator Cap .....	10242	16
2008-2004; Regular Locking Fuel Cap .....	10511		1998-1996; OE Equivalent Fuel Cap .....	10825	
2008-2004; Oil Filler Cap .....	10140		1998-1996; Regular Locking Fuel Cap .....	10595	
			1998-1996; Oil Filler Cap .....	10081	
<b>Grand Vitara</b>			<b>Swift</b>		
<b>4-Cyl. 2.4 L</b>			<b>4-Cyl. 1.3 L</b>		
2011; OE Equivalent Fuel Cap .....	10834		2001-1995; OE Type Radiator Cap .....	10242	16
2011; Regular Locking Fuel Cap .....	10504		2001-1995; OE Equivalent Fuel Cap .....	10825	
2010-2009; OE Type Radiator Cap .....	10242	16	2001-1995; Regular Locking Fuel Cap .....	10595	
2010-2009; OE Equivalent Fuel Cap .....	10834		2001-1995; Oil Filler Cap .....	10081	
2010-2009; Regular Locking Fuel Cap .....	10504				
<b>V-6 2.5 L</b>			<b>4-Cyl. 1.6 L (Canada)</b>		
2005; OE Type Radiator Cap .....	10242	16	2004; OE Type Radiator Cap .....	10259	20
2005; OE Equivalent Fuel Cap .....	10834		2004; OE Equivalent Fuel Cap .....	10841	
2005; Regular Locking Fuel Cap .....	10504		2004; Regular Locking Fuel Cap .....	10511	
2005; Oil Filler Cap .....	10134				
2004; OE Type Radiator Cap .....	10242	16	<b>SX4</b>		
2004; OE Equivalent Fuel Cap .....	10834		<b>4-Cyl. 2.0 L</b>		
2004; Regular Locking Fuel Cap .....	10504		2010; OE Type Radiator Cap .....	10242	16
2004; Oil Filler Cap .....	10081		2009; OE Type Radiator Cap .....	10242	16
2003-1999; OE Type Radiator Cap .....	10242	16	2009; OE Equivalent Fuel Cap .....	10834	
2003-1999; OE Equivalent Fuel Cap .....	10825		2009; Regular Locking Fuel Cap .....	10504	
2003-1999; Regular Locking Fuel Cap .....	10595		2008-2007; OE Type Radiator Cap .....	10242	16
2003-1999; Oil Filler Cap .....	10081		2008-2007; OE Equivalent Fuel Cap .....	10834	
			2008-2007; Regular Locking Fuel Cap .....	10504	
<b>V-6 2.7 L</b>			2008-2007; Oil Filler Cap .....	10134	
2008-2006; Lev-R-Vent Radiator Cap .....	✓10333	16	<b>Verona</b>		
2008-2006; OE Type Radiator Cap .....	10233	16	<b>6-Cyl. 2.5 L</b>		
2008-2006; OE Equivalent Fuel Cap .....	10834		2006-2004; OE Type Radiator Cap .....	10259	20
2008-2006; Regular Locking Fuel Cap .....	10504		2006-2004; OE Equivalent Fuel Cap .....	10834	
2008-2006; Oil Filler Cap .....	10134		2006-2004; Regular Locking Fuel Cap .....	10504	
2001; OE Type Radiator Cap .....	10242	16			
2001; OE Equivalent Fuel Cap .....	10825		<b>Vitara</b>		
2001; Regular Locking Fuel Cap .....	10595		<b>4-Cyl. 1.6 L</b>		
2001; Oil Filler Cap .....	10081		2001; OE Type Radiator Cap .....	10242	16
			2001; OE Equivalent Fuel Cap .....	10825	
<b>V-6 3.2 L</b>			2001; Regular Locking Fuel Cap .....	10595	
2009; OE Equivalent Fuel Cap .....	10834		2001; Oil Filler Cap .....	10081	
2009; Regular Locking Fuel Cap .....	10504		2000-1999; OE Type Radiator Cap .....	10242	16
			2000-1999; OE Equivalent Fuel Cap .....	10825	
<b>Kizashi</b>			2000-1999; Regular Locking Fuel Cap .....	10595	
<b>4-Cyl. 2.4 L</b>			<b>4-Cyl. 1.6 L (Canada)</b>		
2011-2010; OE Equivalent Fuel Cap .....	10834		2002; OE Type Radiator Cap .....	10242	16
2011-2010; Regular Locking Fuel Cap .....	10504		2002; OE Equivalent Fuel Cap .....	10825	
			2002; Regular Locking Fuel Cap .....	10595	
<b>Reno</b>			2002; Oil Filler Cap .....	10081	
<b>4-Cyl. 2.0 L</b>			<b>4-Cyl. 2.0 L</b>		
2008-2005; OE Equivalent Fuel Cap .....	10841		2004-1999; OE Type Radiator Cap .....	10242	16
2008-2005; Regular Locking Fuel Cap .....	10511		2004-1999; OE Equivalent Fuel Cap .....	10825	
2008-2005; Oil Filler Cap .....	10140		2004-1999; Regular Locking Fuel Cap .....	10595	
			2004-1999; Oil Filler Cap .....	10081	
<b>Samurai</b>			<b>V-6 2.5 L</b>		
<b>4-Cyl. 1.3 L</b>			<b>4-Cyl. 1.6 L</b>		
1995; Lev-R-Vent Radiator Cap .....	✓10327	13	2004-1999; OE Type Radiator Cap .....	10242	16
1995; OE Type Radiator Cap .....	10227	13	2004-1999; OE Equivalent Fuel Cap .....	10825	
1995; OE Equivalent Fuel Cap .....	10817		2004-1999; Regular Locking Fuel Cap .....	10595	
1995; Pre-Vent Non-Locking Fuel Cap .....	10819		2004-1999; Oil Filler Cap .....	10081	
1995; Regular Locking Fuel Cap .....	10591				
1995; Pre-Vent Locking Fuel Cap .....	10501		<b>X-90</b>		
1995; Oil Filler Cap .....	10083		<b>4-Cyl. 1.6 L</b>		
			1998-1996; OE Type Radiator Cap .....	10242	16
<b>Sidekick</b>			1998-1996; OE Equivalent Fuel Cap .....	10825	
<b>4-Cyl. 1.6 L</b>			1998-1996; Regular Locking Fuel Cap .....	10595	
1998-1996; OE Type Radiator Cap .....	10242	16	1998-1996; Oil Filler Cap .....	10081	
1998-1996; OE Equivalent Fuel Cap .....	10825				

✓ Check Hood Clearance prior to installing this Cap.

## Caps for Passenger Cars and Light Trucks (1990 and Newer)

Application	Part Number	PSI	Application	Part Number	PSI
<b>Suzuki - Continued</b>			<b>Toyota - Continued</b>		
<b>XL-7</b>			<b>Avalon</b>		
<b>V-6 2.7 L</b>			<b>V-6 3.0 L</b>		
2006-2004; Lev-R-Vent Radiator Cap .....	✓10333	16	2004-2000; Lev-R-Vent Radiator Cap .....	✓10333	16
2006-2004; OE Type Radiator Cap .....	10233	16	2004-2000; OE Type Radiator Cap .....	10233	16
2006-2004; OE Equivalent Fuel Cap .....	10834		2004-2000; OE Equivalent Fuel Cap .....	10834	
2006-2004; Regular Locking Fuel Cap .....	10504		2004-2000; Regular Locking Fuel Cap .....	10504	
2006-2004; Oil Filler Cap .....	10134		2004-2000; Oil Filler Cap .....	10121	
2003-2002; OE Type Radiator Cap .....	10242	16	1999-1997; Lev-R-Vent Radiator Cap .....	✓10333	16
2003-2002; OE Equivalent Fuel Cap .....	10825		1999-1997; OE Type Radiator Cap .....	10233	16
2003-2002; Regular Locking Fuel Cap .....	10595		1999-1997; OE Equivalent Fuel Cap .....	10825	
2003-2002; Oil Filler Cap .....	10081		1999-1997; Regular Locking Fuel Cap .....	10595	
<b>V-6 3.6 L</b>			1999-1997; Oil Filler Cap .....		
2009-2007; OE Type Radiator Cap .....	10248	15	1999-1997; Oil Filler Cap .....	10121	
2009-2007; OE Equivalent Fuel Cap .....	10841		1996-1995; Lev-R-Vent Radiator Cap .....	✓10333	16
2009-2007; Regular Locking Fuel Cap .....	10511		1996-1995; OE Type Radiator Cap .....	10233	16
<b>Toyota</b>			1996-1995; OE Equivalent Fuel Cap .....		
<b>4 Runner</b>			1996-1995; Regular Locking Fuel Cap .....		
<b>4-Cyl. 2.4 L</b>			1996-1995; Oil Filler Cap .....		
1995; Lev-R-Vent Radiator Cap .....	✓10327	13	<b>V-6 3.5 L</b>		
1995; OE Type Radiator Cap .....	10227	13	2011; OE Equivalent Fuel Cap .....	10834	
1995; OE Equivalent Fuel Cap .....	10825		2011; Regular Locking Fuel Cap .....	10504	
1995; Regular Locking Fuel Cap .....	10595		2010; OE Type Radiator Cap .....	10242	16
1995; Oil Filler Cap .....	10080		2010; OE Equivalent Fuel Cap .....	10834	
<b>4-Cyl. 2.7 L</b>			2010; Regular Locking Fuel Cap .....	10242	16
2010; OE Type Radiator Cap .....	10242	16	2010; OE Equivalent Fuel Cap .....	10504	
2010; OE Equivalent Fuel Cap .....	10834		2000-1996; OE Type Radiator Cap .....	10241	13
2010; Regular Locking Fuel Cap .....	10504		2000-1996; OE Equivalent Fuel Cap .....	10825	
2000-1996; OE Type Radiator Cap .....	10241	13	2000-1996; Regular Locking Fuel Cap .....	10595	
2000-1996; OE Equivalent Fuel Cap .....	10825		2000-1996; Oil Filler Cap .....	10080	
2000-1996; Regular Locking Fuel Cap .....	10595		<b>Camry</b>		
2000-1996; Oil Filler Cap .....	10080		<b>4-Cyl. 2.2 L</b>		
<b>V-6 3.0 L</b>			2001-2000; OE Type Radiator Cap .....		
1995; Lev-R-Vent Radiator Cap .....	✓10327	13	2001-2000; OE Equivalent Fuel Cap .....		
1995; OE Type Radiator Cap .....	10227	13	2001-2000; Regular Locking Fuel Cap .....		
1995; OE Equivalent Fuel Cap .....	10825		2001-2000; Oil Filler Cap .....		
1995; Regular Locking Fuel Cap .....	10595		1999; OE Type Radiator Cap .....		
1995; Oil Filler Cap .....	10080		1999; OE Equivalent Fuel Cap; Models made in USA.; Early .....		
<b>V-6 3.4 L</b>			1999; Regular Locking Fuel Cap; Models made in USA.; Early ..		
2002-2001; OE Type Radiator Cap .....	10242	16	1999; OE Equivalent Fuel Cap; Models made in USA.; Late .....		
2002-2001; OE Equivalent Fuel Cap .....	10834		1999; Regular Locking Fuel Cap; Models made in USA.; Late ...		
2002-2001; Regular Locking Fuel Cap .....	10504		1999; Oil Filler Cap .....		
2002-2001; Oil Filler Cap .....	10080		1998-1995; OE Type Radiator Cap .....		
2000-1996; OE Type Radiator Cap .....	10241	13	1998-1995; OE Equivalent Fuel Cap .....		
2000-1996; OE Equivalent Fuel Cap .....	10825		1998-1995; Regular Locking Fuel Cap .....		
2000-1996; Regular Locking Fuel Cap .....	10595		1998-1995; Oil Filler Cap .....		
2000-1996; Oil Filler Cap .....	10080		<b>4-Cyl. 2.4 L</b>		
<b>V-6 4.0 L</b>			2009-2007; OE Type Radiator Cap .....		
2011; OE Type Radiator Cap .....	10242	16	2009-2007; OE Equivalent Fuel Cap .....		
2011; OE Equivalent Fuel Cap .....	10834		2009-2007; Regular Locking Fuel Cap .....		
2011; Regular Locking Fuel Cap .....	10504		2009-2007; Oil Filler Cap .....		
2010; OE Type Radiator Cap .....	10242	16	2006-2003; OE Type Radiator Cap .....		
2010; OE Equivalent Fuel Cap .....	10834		2006-2003; OE Equivalent Fuel Cap .....		
2010; Regular Locking Fuel Cap .....	10504		2006-2003; Regular Locking Fuel Cap .....		
2010; Oil Filler Cap .....	10135		2006-2003; Oil Filler Cap .....		
2009-2004; OE Type Radiator Cap .....	10242	16	2002; OE Type Radiator Cap .....		
2009-2004; OE Equivalent Fuel Cap .....	10839		2002; OE Equivalent Fuel Cap; W/Threaded Filler Neck .....		
2009-2004; Regular Locking Fuel Cap .....	10509		2002; Regular Locking Fuel Cap; W/Threaded Filler Neck .....		
2009-2004; Oil Filler Cap .....	10135		2002; OE Equivalent Fuel Cap; W/O Threaded Filler Neck .....		
2003; OE Type Radiator Cap .....	10242	16	2002; Regular Locking Fuel Cap; W/O Threaded Filler Neck .....		
2003; OE Equivalent Fuel Cap .....	10839		2002; Oil Filler Cap .....		
2003; Regular Locking Fuel Cap .....	10509		<b>4-Cyl. 2.4 L Electric Assist</b>		
2003; Oil Filler Cap .....	10080		2011; OE Type Radiator Cap .....		
<b>V-8 4.7 L</b>			2011; Oil Filler Cap .....		
2009; OE Type Radiator Cap .....	10242	16	2010-2007; OE Type Radiator Cap .....		
2009; OE Equivalent Fuel Cap .....	10839		2010-2007; OE Equivalent Fuel Cap .....		
2009; Regular Locking Fuel Cap .....	10509		2010-2007; Regular Locking Fuel Cap .....		
2009; Oil Filler Cap .....	10135		2010-2007; Oil Filler Cap .....		
2008-2003; OE Type Radiator Cap .....	10242	16	<b>4-Cyl. 2.5 L</b>		
2008-2003; OE Equivalent Fuel Cap .....	10839		2012; OE Equivalent Fuel Cap .....		
2008-2003; Regular Locking Fuel Cap .....	10509		2012; Regular Locking Fuel Cap .....		
2008-2003; Oil Filler Cap .....	10080		2011-2010; OE Type Radiator Cap .....		

✓ Check Hood Clearance prior to installing this Cap.

## Caps for Passenger Cars and Light Trucks (1990 and Newer)

Application	Part Number	PSI	Application	Part Number	PSI
<b>Toyota - Continued</b>			<b>Toyota - Continued</b>		
<b>Camry - Continued</b>			<b>Camry Solara - Continued</b>		
<b>4-Cyl. 2.5 L - Continued</b>			<b>V-6 3.0 L - Continued</b>		
2011-2010; OE Equivalent Fuel Cap .....	10834		2000; Oil Filler Cap .....	10121	
2011-2010; Regular Locking Fuel Cap .....	10504		1999; Lev-R-Vent Radiator Cap .....	✓10333	16
2011-2010; Oil Filler Cap .....	10135		1999; OE Type Radiator Cap .....	10233	16
<b>V-6 3.0 L</b>			1999; OE Equivalent Fuel Cap; Models made in USA.; Early .....	10825	
2006-2003; Lev-R-Vent Radiator Cap .....	✓10333	16	1999; Regular Locking Fuel Cap; Models made in USA.; Early ..	10595	
2006-2003; OE Type Radiator Cap .....	10233	16	1999; OE Equivalent Fuel Cap; Models made in USA.; Late .....	10834	
2006-2003; OE Equivalent Fuel Cap .....	10839		1999; Regular Locking Fuel Cap; Models made in USA.; Late .....	10504	
2006-2003; Regular Locking Fuel Cap .....	10509		1999; Oil Filler Cap .....	10121	
2006-2003; Oil Filler Cap .....	10121		<b>Celica</b>		
2002; Lev-R-Vent Radiator Cap .....	✓10333	16	<b>4-Cyl. 1.8 L</b>		
2002; OE Type Radiator Cap .....	10233	16	2005-2000; OE Type Radiator Cap .....	10254	19
2002; OE Equivalent Fuel Cap; W/Threaded Filler Neck .....	10834		2005-2000; OE Equivalent Fuel Cap .....	10834	
2002; Regular Locking Fuel Cap; W/Threaded Filler Neck .....	10504		2005-2000; Regular Locking Fuel Cap .....	10504	
2002; OE Equivalent Fuel Cap; W/O Threaded Filler Neck .....	10839		2005-2000; Oil Filler Cap .....	10080	
2002; Regular Locking Fuel Cap; W/O Threaded Filler Neck .....	10509		1997-1995; OE Type Radiator Cap .....	10241	13
2002; Oil Filler Cap .....	10121		1997-1995; OE Equivalent Fuel Cap .....	10825	
2001-2000; Lev-R-Vent Radiator Cap .....	✓10333	16	1997-1995; Regular Locking Fuel Cap .....	10595	
2001-2000; OE Type Radiator Cap .....	10233	16	1997-1995; Oil Filler Cap .....	10080	
2001-2000; OE Equivalent Fuel Cap .....	10834		<b>4-Cyl. 2.2 L</b>		
2001-2000; Regular Locking Fuel Cap .....	10504		1999-1995; OE Type Radiator Cap .....	10241	13
2001-2000; Oil Filler Cap .....	10121		1999-1995; OE Equivalent Fuel Cap .....	10825	
1999; Lev-R-Vent Radiator Cap .....	✓10333	16	1999-1995; Regular Locking Fuel Cap .....	10595	
1999; OE Type Radiator Cap .....	10233	16	1999-1995; Oil Filler Cap .....	10080	
1999; OE Equivalent Fuel Cap; Models made in USA.; Early .....	10825		<b>Corolla</b>		
1999; Regular Locking Fuel Cap; Models made in USA.; Early ..	10595		<b>4-Cyl. 1.6 L</b>		
1999; OE Equivalent Fuel Cap; Models made in USA.; Late .....	10834		1997-1995; OE Type Radiator Cap .....	10241	13
1999; Regular Locking Fuel Cap; Models made in USA.; Late .....	10504		1997-1995; OE Equivalent Fuel Cap .....	10825	
1999; Oil Filler Cap .....	10121		1997-1995; Regular Locking Fuel Cap .....	10595	
1998-1995; Lev-R-Vent Radiator Cap .....	✓10333	16	1997-1995; Oil Filler Cap .....	10080	
1998-1995; OE Type Radiator Cap .....	10233	16	<b>4-Cyl. 1.8 L</b>		
1998-1995; OE Equivalent Fuel Cap .....	10825		2011-2007; OE Type Radiator Cap .....	10241	13
1998-1995; Regular Locking Fuel Cap .....	10595		2011-2007; OE Equivalent Fuel Cap .....	10834	
1998-1995; Oil Filler Cap .....	10113		2011-2007; Regular Locking Fuel Cap .....	10504	
<b>V-6 3.3 L</b>			2011-2007; Oil Filler Cap .....	10135	
2006-2004; Lev-R-Vent Radiator Cap .....	✓10333	16	2006-2005; OE Type Radiator Cap .....	10241	13
2006-2004; OE Type Radiator Cap .....	10233	16	2006-2005; OE Equivalent Fuel Cap; W/O Threaded Filler Neck ..	10839	
2006-2004; OE Equivalent Fuel Cap .....	10839		2006-2005; Regular Locking Fuel Cap; W/O Threaded Filler Neck .....	10509	
2006-2004; Regular Locking Fuel Cap .....	10509		2006-2005; OE Equivalent Fuel Cap; W/Threaded Filler Neck ...	10834	
2006-2004; Oil Filler Cap .....	10121		2006-2005; Regular Locking Fuel Cap; W/Threaded Filler Neck ..	10504	
<b>V-6 3.5 L</b>			2006-2005; Oil Filler Cap .....	10135	
2012; OE Equivalent Fuel Cap .....	10834		2004-2003; OE Type Radiator Cap .....	10241	13
2012; Regular Locking Fuel Cap .....	10504		2004-2003; OE Equivalent Fuel Cap .....	10834	
2011-2010; OE Type Radiator Cap .....	10242	16	2004-2003; Regular Locking Fuel Cap .....	10504	
2011-2010; OE Equivalent Fuel Cap .....	10834		2004-2003; Oil Filler Cap .....	10135	
2011-2010; Regular Locking Fuel Cap .....	10504		2002-2000; OE Type Radiator Cap .....	10241	13
2011-2010; Oil Filler Cap .....	10135		2002-2000; OE Equivalent Fuel Cap .....	10834	
2009; OE Type Radiator Cap .....	10242	16	2002-2000; Regular Locking Fuel Cap .....	10504	
2009; OE Equivalent Fuel Cap .....	10834		2002-2000; Oil Filler Cap .....	10080	
2009; Regular Locking Fuel Cap .....	10504		1999-1995; OE Type Radiator Cap .....	10241	13
2009; Oil Filler Cap .....	10080		1999-1995; OE Equivalent Fuel Cap .....	10825	
2008-2007; OE Type Radiator Cap .....	10242	16	1999-1995; Regular Locking Fuel Cap .....	10595	
2008-2007; OE Equivalent Fuel Cap .....	10834		1999-1995; Oil Filler Cap .....	10080	
2008-2007; Regular Locking Fuel Cap .....	10504		<b>4-Cyl. 2.4 L</b>		
2008-2007; Oil Filler Cap .....	10135		2010-2009; OE Type Radiator Cap .....	10241	13
<b>Camry Solara</b>			2010-2009; OE Equivalent Fuel Cap .....	10834	
<b>4-Cyl. 2.2 L</b>			2010-2009; Regular Locking Fuel Cap .....	10504	
2000; OE Type Radiator Cap .....	10241	13	2010-2009; Oil Filler Cap .....	10135	
2000; OE Equivalent Fuel Cap .....	10834		<b>Echo</b>		
2000; Regular Locking Fuel Cap .....	10504		<b>4-Cyl. 1.5 L</b>		
2000; Oil Filler Cap .....	10080		2005; OE Type Radiator Cap .....	10242	16
1999; OE Type Radiator Cap .....	10241	13	2005; OE Equivalent Fuel Cap .....	10834	
1999; OE Equivalent Fuel Cap; Models made in USA.; Early .....	10825		2005; Regular Locking Fuel Cap .....	10504	
1999; Regular Locking Fuel Cap; Models made in USA.; Early ..	10595		2005; Oil Filler Cap .....	10135	
1999; OE Equivalent Fuel Cap; Models made in USA.; Late .....	10834		2004-2003; OE Type Radiator Cap .....	10242	16
1999; Regular Locking Fuel Cap; Models made in USA.; Late .....	10504		2004-2003; OE Equivalent Fuel Cap .....	10834	
1999; Oil Filler Cap .....	10080		2004-2003; Regular Locking Fuel Cap .....	10504	
<b>V-6 3.0 L</b>			2004-2003; Oil Filler Cap .....	10080	
2000; Lev-R-Vent Radiator Cap .....	✓10333	16	2002-2000; OE Type Radiator Cap .....	10242	16
2000; OE Type Radiator Cap .....	10233	16			
2000; OE Equivalent Fuel Cap .....	10834				
2000; Regular Locking Fuel Cap .....	10504				

✓ Check Hood Clearance prior to installing this Cap.



## Caps for Passenger Cars and Light Trucks (1990 and Newer)

Application	Part Number	PSI	Application	Part Number	PSI
<b>Toyota - Continued</b>			<b>Toyota - Continued</b>		
<b>Echo - Continued</b>			<b>Highlander - Continued</b>		
<b>4-Cyl. 1.5 L - Continued</b>			<b>V-6 3.5 L</b>		
2002-2000: OE Equivalent Fuel Cap .....	10834		2012-2011: OE Type Radiator Cap .....	10242	16
2002-2000: Regular Locking Fuel Cap .....	10504		2012-2011: OE Equivalent Fuel Cap .....	10834	
2002-2000: Oil Filler Cap .....	10135		2012-2011: Regular Locking Fuel Cap .....	10504	
<b>FJ Cruiser</b>			2010-2009: OE Type Radiator Cap .....	10242	16
<b>V-6 4.0 L</b>			2010-2009: OE Equivalent Fuel Cap .....	10834	
2012: OE Equivalent Fuel Cap .....	10834		2010-2009: Regular Locking Fuel Cap .....	10504	
2012: Regular Locking Fuel Cap .....	10504		2010-2009: Oil Filler Cap; W/Trlr. Tow. Pkg. ....	10080	
2011: OE Type Radiator Cap .....	10242	16	2010-2009: Oil Filler Cap; W/O Trlr. Tow. Pkg. ....	10135	
2011: OE Equivalent Fuel Cap .....	10834		2008: OE Type Radiator Cap .....	10242	16
2011: Regular Locking Fuel Cap .....	10504		2008: OE Equivalent Fuel Cap .....	10834	
2010-2007: OE Type Radiator Cap .....	10242	16	2008: Regular Locking Fuel Cap .....	10504	
2010-2007: OE Equivalent Fuel Cap .....	10834		2008: Oil Filler Cap; W/Trans. Oil Cooler .....	10080	
2010-2007: Regular Locking Fuel Cap .....	10504		2008: Oil Filler Cap; W/O Trans. Oil Cooler .....	10135	
2010-2007: Oil Filler Cap .....	10135		<b>V-6 3.5 L Electric Assist</b>		
<b>Highlander</b>			2012: OE Equivalent Fuel Cap .....	10834	
<b>4-Cyl. 2.4 L</b>			2012: Regular Locking Fuel Cap .....	10504	
2007: OE Type Radiator Cap .....	10242	16	2011: OE Type Radiator Cap .....	10242	16
2007: OE Equivalent Fuel Cap .....	10834		2011: OE Equivalent Fuel Cap .....	10834	
2007: Regular Locking Fuel Cap .....	10504		2011: Regular Locking Fuel Cap .....	10504	
2007: Oil Filler Cap .....	10135		<b>Land Cruiser</b>		
2006-2004: OE Type Radiator Cap .....	10242	16	<b>6-Cyl. 4.5 L</b>		
2006-2004: OE Equivalent Fuel Cap .....	10839		1997-1995: Lev-R-Vent Radiator Cap .....	✓10327	13
2006-2004: Regular Locking Fuel Cap .....	10509		1997-1995: OE Type Radiator Cap .....	10227	13
2006-2004: Oil Filler Cap .....	10135		1997-1995: OE Equivalent Fuel Cap .....	10825	
2003-2001: OE Type Radiator Cap .....	10242	16	1997-1995: Regular Locking Fuel Cap .....	10595	
2003-2001: OE Equivalent Fuel Cap .....	10834		1997-1995: Oil Filler Cap .....	10080	
2003-2001: Regular Locking Fuel Cap .....	10504		<b>V-8 4.7 L</b>		
2003-2001: Oil Filler Cap .....	10135		2007-2000: Lev-R-Vent Radiator Cap .....	✓10333	16
<b>4-Cyl. 2.7 L</b>			2007-2000: OE Type Radiator Cap .....	10233	16
2012: OE Equivalent Fuel Cap .....	10834		2007-2000: OE Equivalent Fuel Cap .....	10834	
2012: Regular Locking Fuel Cap .....	10504		2007-2000: Regular Locking Fuel Cap .....	10504	
2011: OE Type Radiator Cap .....	10242	16	2007-2000: Oil Filler Cap .....	10080	
2011: OE Equivalent Fuel Cap .....	10834		1999-1998: Lev-R-Vent Radiator Cap .....	✓10333	16
2011: Regular Locking Fuel Cap .....	10504		1999-1998: OE Type Radiator Cap .....	10233	16
2010-2009: OE Type Radiator Cap .....	10242	16	1999-1998: OE Equivalent Fuel Cap .....	10825	
2010-2009: OE Equivalent Fuel Cap .....	10834		1999-1998: Regular Locking Fuel Cap .....	10595	
2010-2009: Regular Locking Fuel Cap .....	10504		1999-1998: Oil Filler Cap .....	10080	
2010-2009: Oil Filler Cap .....	10135		<b>V-8 5.7 L</b>		
<b>V-6 3.0 L</b>			2011: OE Type Radiator Cap .....	10242	16
2003-2001: OE Type Radiator Cap .....	10242	16	2011: OE Equivalent Fuel Cap .....	10834	
2003-2001: OE Equivalent Fuel Cap .....	10834		2011: Regular Locking Fuel Cap .....	10504	
2003-2001: Regular Locking Fuel Cap .....	10504		2011: Oil Filler Cap .....	10135	
2003-2001: Oil Filler Cap .....	10121		2010: OE Type Radiator Cap .....	10242	16
<b>V-6 3.3 L</b>			2010: Oil Filler Cap .....	10135	
2007: OE Type Radiator Cap .....	10242	16	2009-2008: OE Type Radiator Cap .....	10242	16
2007: OE Equivalent Fuel Cap .....	10834		2009-2008: OE Equivalent Fuel Cap .....	10834	
2007: Regular Locking Fuel Cap .....	10504		2009-2008: Regular Locking Fuel Cap .....	10504	
2007: Oil Filler Cap .....	10121		2009-2008: Oil Filler Cap .....	10135	
2006: OE Type Radiator Cap .....	10241	13	<b>Matrix</b>		
2006: OE Equivalent Fuel Cap .....	10839		<b>4-Cyl. 1.8 L</b>		
2006: Regular Locking Fuel Cap .....	10509		2011-2006: OE Type Radiator Cap .....	10241	13
2006: Oil Filler Cap .....	10121		2011-2006: OE Equivalent Fuel Cap .....	10834	
2005-2004: OE Type Radiator Cap .....	10242	16	2011-2006: Regular Locking Fuel Cap .....	10504	
2005-2004: OE Equivalent Fuel Cap .....	10839		2011-2006: Oil Filler Cap .....	10135	
2005-2004: Regular Locking Fuel Cap .....	10509		2005: OE Type Radiator Cap .....	10241	13
2005-2004: Oil Filler Cap .....	10121		2005: OE Equivalent Fuel Cap; W/AWD .....	10834	
<b>V-6 3.3 L Electric Assist</b>			2005: Regular Locking Fuel Cap; W/AWD .....	10504	
2010-2009: OE Type Radiator Cap .....	10242	16	2005: OE Equivalent Fuel Cap; W/FWD .....	10839	
2010-2009: OE Equivalent Fuel Cap .....	10834		2005: Regular Locking Fuel Cap; W/FWD .....	10509	
2010-2009: Regular Locking Fuel Cap .....	10504		2005: Oil Filler Cap .....	10135	
2010-2009: Oil Filler Cap .....	10121		2004-2003: OE Type Radiator Cap .....	10241	13
2008-2007: OE Type Radiator Cap .....	10241	13	2004-2003: OE Equivalent Fuel Cap .....	10834	
2008-2007: OE Equivalent Fuel Cap .....	10834		2004-2003: Regular Locking Fuel Cap .....	10504	
2008-2007: Regular Locking Fuel Cap .....	10504		2004-2003: Oil Filler Cap .....	10135	
2008-2007: Oil Filler Cap .....	10121		<b>4-Cyl. 2.4 L</b>		
2006: OE Type Radiator Cap .....	10242	16	2011-2009: OE Type Radiator Cap .....	10241	13
2006: OE Equivalent Fuel Cap .....	10834		2011-2009: OE Equivalent Fuel Cap .....	10834	
2006: Regular Locking Fuel Cap .....	10504		2011-2009: Regular Locking Fuel Cap .....	10504	
2006: Oil Filler Cap .....	10121		2011-2009: Oil Filler Cap .....	10135	

✓ Check Hood Clearance prior to installing this Cap.

## Caps for Passenger Cars and Light Trucks (1990 and Newer)

Application	Part Number	PSI	Application	Part Number	PSI
<b>Toyota - Continued</b>			<b>Toyota - Continued</b>		
<b>MR2</b>			<b>Prius - Continued</b>		
4-Cyl. 2.0 L; 4-Cyl. 2.2 L			4-Cyl. 1.8 L Electric Assist - Continued		
1995: Lev-R-Vent Radiator Cap .....	✓10327	13	2011: OE Equivalent Fuel Cap .....	10834	
1995: OE Type Radiator Cap .....	10227	13	2011: Regular Locking Fuel Cap .....	10504	
1995: OE Equivalent Fuel Cap .....	10825		2011: Oil Filler Cap .....	10135	
1995: Regular Locking Fuel Cap .....	10595		2010: OE Type Radiator Cap .....	10254	19
1995: Oil Filler Cap .....	10080		2010: OE Equivalent Fuel Cap .....	10834	
			2010: Regular Locking Fuel Cap .....	10504	
<b>MR2 Spyder</b>			<b>RAV4</b>		
4-Cyl. 1.8 L			4-Cyl. 2.0 L		
2005: OE Type Radiator Cap .....	10254	19	2003-2001: OE Type Radiator Cap .....	10242	16
2005: OE Equivalent Fuel Cap .....	10834		2003-2001: OE Equivalent Fuel Cap .....	10834	
2005: Regular Locking Fuel Cap .....	10504		2003-2001: Regular Locking Fuel Cap .....	10504	
2005: Oil Filler Cap .....	10135		2003-2001: Oil Filler Cap .....	10080	
2004: OE Type Radiator Cap .....	10254	19	2000: OE Type Radiator Cap .....	10242	16
2004: OE Equivalent Fuel Cap .....	10834		2000: OE Equivalent Fuel Cap .....	10825	
2004: Regular Locking Fuel Cap .....	10504		2000: Regular Locking Fuel Cap .....	10595	
2003: OE Type Radiator Cap .....	10254	19	2000: Oil Filler Cap .....	10080	
2003: OE Equivalent Fuel Cap .....	10834		1999: OE Type Radiator Cap .....	10241	13
2003: Regular Locking Fuel Cap .....	10504		1999: OE Equivalent Fuel Cap .....	10825	
2003: Oil Filler Cap .....	10080		1999: Regular Locking Fuel Cap .....	10595	
2002: OE Type Radiator Cap .....	10254	19	1999: Oil Filler Cap .....	10080	
2002: OE Equivalent Fuel Cap .....	10834		1998: OE Type Radiator Cap .....	10242	16
2002: Regular Locking Fuel Cap .....	10504		1998: OE Equivalent Fuel Cap .....	10825	
2002: Oil Filler Cap .....	10135		1998: Regular Locking Fuel Cap .....	10595	
2001-2000: OE Type Radiator Cap .....	10254	19	1998: Oil Filler Cap .....	10080	
2001-2000: OE Equivalent Fuel Cap .....	10834		1997-1996: OE Type Radiator Cap .....	10241	13
2001-2000: Regular Locking Fuel Cap .....	10504		1997-1996: OE Equivalent Fuel Cap .....	10825	
2001-2000: Oil Filler Cap .....	10080		1997-1996: Regular Locking Fuel Cap .....	10595	
			1997-1996: Oil Filler Cap .....	10080	
<b>Paseo</b>			4-Cyl. 2.4 L		
4-Cyl. 1.5 L			2008-2006: OE Type Radiator Cap .....		
1997-1995: OE Type Radiator Cap .....	10241	13		10254	19
1997-1995: OE Equivalent Fuel Cap .....	10825		2008-2006: OE Equivalent Fuel Cap .....	10834	
1997-1995: Regular Locking Fuel Cap .....	10595		2008-2006: Regular Locking Fuel Cap .....	10504	
1997-1995: Oil Filler Cap .....	10080		2008-2006: Oil Filler Cap .....	10135	
4-Cyl. 1.5 L (Canada)			2005: OE Type Radiator Cap .....		
1998: OE Type Radiator Cap .....	10241	13		10242	16
1998: OE Equivalent Fuel Cap .....	10825		2005: OE Equivalent Fuel Cap .....	10834	
1998: Regular Locking Fuel Cap .....	10595		2005: Regular Locking Fuel Cap .....	10504	
1998: Oil Filler Cap .....	10080		2005: Oil Filler Cap .....	10135	
<b>Pickup</b>			2004: OE Type Radiator Cap .....		
4-Cyl. 2.4 L; V-6 3.0 L					
1995: Lev-R-Vent Radiator Cap .....	✓10327	13		10242	16
1995: OE Type Radiator Cap .....	10227	13	2004: OE Equivalent Fuel Cap .....	10834	
1995: OE Equivalent Fuel Cap .....	10825		2004: Regular Locking Fuel Cap .....	10504	
1995: Regular Locking Fuel Cap .....	10595		2004: Oil Filler Cap .....	10080	
1995: Oil Filler Cap .....	10080		4-Cyl. 2.5 L		
<b>Previa</b>			2011-2009: OE Type Radiator Cap .....		
4-Cyl. 2.4 L					
1997-1995: Lev-R-Vent Radiator Cap .....	✓10327	13		10254	19
1997-1995: OE Type Radiator Cap .....	10227	13	2011-2009: OE Equivalent Fuel Cap .....	10834	
1997-1995: OE Equivalent Fuel Cap .....	10825		2011-2009: Regular Locking Fuel Cap .....	10504	
1997-1995: Regular Locking Fuel Cap .....	10595		2011-2009: Oil Filler Cap .....	10080	
1997-1995: Oil Filler Cap .....	10112		2008-2006: OE Type Radiator Cap .....	10254	19
<b>Prius</b>			2008-2006: OE Equivalent Fuel Cap .....		
4-Cyl. 1.5 L Electric Assist					
2009-2005: OE Type Radiator Cap .....	10241	13		10834	
2009-2005: OE Equivalent Fuel Cap .....	10839		2008-2006: Regular Locking Fuel Cap .....	10504	
2009-2005: Regular Locking Fuel Cap .....	10509		2008-2006: Oil Filler Cap .....	10135	
2009-2005: Oil Filler Cap .....	10135		<b>Sequoia</b>		
2004: OE Type Radiator Cap .....	10241	13	V-8 4.6 L		
2004: OE Equivalent Fuel Cap .....	10839		2012: OE Equivalent Fuel Cap .....		
2004: Regular Locking Fuel Cap .....	10509			10834	
2004: Oil Filler Cap .....	10080		2012: Regular Locking Fuel Cap .....	10504	
2003-2001: OE Type Radiator Cap .....	10241	13	2011: OE Type Radiator Cap .....	10242	16
2003-2001: OE Equivalent Fuel Cap .....	10834		2011: OE Equivalent Fuel Cap .....	10834	
2003-2001: Regular Locking Fuel Cap .....	10504		2011: Regular Locking Fuel Cap .....	10504	
2003-2001: Oil Filler Cap .....	10080		2010: OE Type Radiator Cap .....	10242	16
4-Cyl. 1.8 L Electric Assist			2010: OE Equivalent Fuel Cap .....		
2011: OE Type Radiator Cap .....	10254	19		10834	
			2010: Regular Locking Fuel Cap .....	10504	
			2010: Oil Filler Cap .....	10135	
			V-8 4.7 L		
			2009: OE Type Radiator Cap .....		
				10242	16
			2009: OE Equivalent Fuel Cap .....	10834	
			2009: Regular Locking Fuel Cap .....	10504	

✓ Check Hood Clearance prior to installing this Cap.

## Caps for Passenger Cars and Light Trucks (1990 and Newer)

Application	Part Number	PSI	Application	Part Number	PSI
<b>Toyota - Continued</b>			<b>Toyota - Continued</b>		
<b>Sequoia - Continued</b>			<b>Solara - Continued</b>		
<b>V-8 4.7 L - Continued</b>			<b>4-Cyl. 2.2 L - Continued</b>		
2008; OE Type Radiator Cap .....	10242	16	2001; OE Equivalent Fuel Cap .....	10834	
2008; OE Equivalent Fuel Cap .....	10834		2001; Regular Locking Fuel Cap .....	10504	
2008; Regular Locking Fuel Cap .....	10504		2001; Oil Filler Cap .....	10080	
2008; Oil Filler Cap .....	10080		<b>4-Cyl. 2.4 L</b>		
2007-2005; OE Type Radiator Cap .....	10241	13	2008-2007; OE Type Radiator Cap .....	10242	16
2007-2005; OE Equivalent Fuel Cap .....	10839		2008-2007; OE Equivalent Fuel Cap .....	10834	
2007-2005; Regular Locking Fuel Cap .....	10509		2008-2007; Regular Locking Fuel Cap .....	10504	
2007-2005; Oil Filler Cap .....	10080		2008-2007; Oil Filler Cap .....	10135	
2004-2001; OE Type Radiator Cap .....	10241	13	2006-2004; OE Type Radiator Cap .....	10242	16
2004-2001; OE Equivalent Fuel Cap .....	10834		2006-2004; OE Equivalent Fuel Cap .....	10839	
2004-2001; Regular Locking Fuel Cap .....	10504		2006-2004; Regular Locking Fuel Cap .....	10509	
2004-2001; Oil Filler Cap .....	10080		2006-2004; Oil Filler Cap .....	10135	
<b>V-8 5.7 L</b>			2003-2002; OE Type Radiator Cap .....	10242	16
2012; OE Equivalent Fuel Cap .....	10834		2003-2002; OE Equivalent Fuel Cap .....	10834	
2012; Flex Fuel Regular Fuel Cap .....	10834Y		2003-2002; Regular Locking Fuel Cap .....	10504	
2012; Regular Locking Fuel Cap .....	10504		2003-2002; Oil Filler Cap .....	10135	
2012; Flex Fuel Regular Locking Fuel Cap .....	10504Y		<b>V-6 3.0 L</b>		
2011-2010; OE Type Radiator Cap .....	10242	16	2003-2001; Lev-R-Vent Radiator Cap .....	✓10333	16
2011-2010; OE Equivalent Fuel Cap .....	10834		2003-2001; OE Type Radiator Cap .....	10233	16
2011-2010; Regular Locking Fuel Cap .....	10504		2003-2001; OE Equivalent Fuel Cap .....	10834	
2011-2010; Flex Fuel Regular Fuel Cap .....	10834Y		2003-2001; Regular Locking Fuel Cap .....	10504	
2011-2010; Flex Fuel Regular Locking Fuel Cap .....	10504Y		2003-2001; Oil Filler Cap .....	10121	
2011-2010; Oil Filler Cap .....	10135		<b>V-6 3.3 L</b>		
2009; OE Type Radiator Cap .....	10242	16	2008-2007; Lev-R-Vent Radiator Cap .....	✓10333	16
2009; OE Equivalent Fuel Cap .....	10834		2008-2007; OE Type Radiator Cap .....	10233	16
2009; Flex Fuel Regular Fuel Cap .....	10834Y		2008-2007; OE Equivalent Fuel Cap .....	10834	
2009; Regular Locking Fuel Cap .....	10504		2008-2007; Regular Locking Fuel Cap .....	10504	
2009; Flex Fuel Regular Locking Fuel Cap .....	10504Y		2008-2007; Oil Filler Cap .....	10121	
2009; Oil Filler Cap .....	10135		2006-2005; Lev-R-Vent Radiator Cap .....	✓10333	16
2008; OE Type Radiator Cap .....	10242	16	2006-2005; OE Type Radiator Cap .....	10233	16
2008; OE Equivalent Fuel Cap .....	10834		2006-2005; OE Equivalent Fuel Cap .....	10839	
2008; Regular Locking Fuel Cap .....	10504		2006-2005; Regular Locking Fuel Cap .....	10509	
2008; Oil Filler Cap .....	10135		2006-2005; Oil Filler Cap .....	10121	
<b>Sienna</b>			2004; OE Type Radiator Cap .....	10242	16
<b>4-Cyl. 2.7 L</b>			2004; OE Equivalent Fuel Cap .....	10839	
2012; OE Equivalent Fuel Cap .....	10834		2004; Regular Locking Fuel Cap .....	10509	
2012; Regular Locking Fuel Cap .....	10504		2004; Oil Filler Cap .....	10121	
2011; OE Type Radiator Cap .....	10242	16	<b>Supra</b>		
2011; OE Equivalent Fuel Cap .....	10834		<b>6-Cyl. 3.0 L</b>		
2011; Regular Locking Fuel Cap .....	10504		1998-1997; OE Type Radiator Cap .....	10242	16
<b>V-6 3.0 L</b>			1998-1997; OE Equivalent Fuel Cap .....	10825	
2003-1999; Lev-R-Vent Radiator Cap .....	✓10333	16	1998-1997; Regular Locking Fuel Cap .....	10595	
2003-1999; OE Type Radiator Cap .....	10233	16	1998-1997; Oil Filler Cap .....	10121	
2003-1999; OE Equivalent Fuel Cap .....	10834		1996-1995; OE Type Radiator Cap .....	10242	16
2003-1999; Regular Locking Fuel Cap .....	10504		1996-1995; OE Equivalent Fuel Cap .....	10825	
2003-1999; Oil Filler Cap .....	10121		1996-1995; Regular Locking Fuel Cap .....	10595	
1998; Lev-R-Vent Radiator Cap .....	✓10333	16	1996-1995; Oil Filler Cap .....	10113	
1998; OE Type Radiator Cap .....	10233	16	<b>T100</b>		
1998; OE Equivalent Fuel Cap .....	10825		<b>4-Cyl. 2.7 L</b>		
1998; Regular Locking Fuel Cap .....	10595		1998-1995; Lev-R-Vent Radiator Cap; W/Auto. Trans. ....	✓10327	13
1998; Oil Filler Cap .....	10121		1998-1995; OE Type Radiator Cap; W/Auto. Trans. ....	10227	13
<b>V-6 3.3 L</b>			1998-1995; OE Type Radiator Cap; W/Man. Trans. ....	10241	13
2006-2004; Lev-R-Vent Radiator Cap .....	✓10333	16	1998-1995; OE Equivalent Fuel Cap .....	10825	
2006-2004; OE Type Radiator Cap .....	10233	16	1998-1995; Regular Locking Fuel Cap .....	10595	
2006-2004; OE Equivalent Fuel Cap .....	10839		1998-1995; Oil Filler Cap .....	10080	
2006-2004; Regular Locking Fuel Cap .....	10509		<b>V-6 3.4 L</b>		
2006-2004; Oil Filler Cap .....	10121		1998-1995; Lev-R-Vent Radiator Cap .....	✓10327	13
<b>V-6 3.5 L</b>			1998-1995; OE Type Radiator Cap .....	10227	13
2012; OE Equivalent Fuel Cap .....	10834		1998-1995; OE Equivalent Fuel Cap .....	10825	
2012; Regular Locking Fuel Cap .....	10504		1998-1995; Regular Locking Fuel Cap .....	10595	
2011; OE Type Radiator Cap .....	10242	16	1998-1995; Oil Filler Cap .....	10080	
2011; OE Equivalent Fuel Cap .....	10834		<b>Tacoma</b>		
2011; Regular Locking Fuel Cap .....	10504		<b>4-Cyl. 2.4 L</b>		
2010-2007; OE Type Radiator Cap .....	10242	16	2004-2000; Lev-R-Vent Radiator Cap .....	✓10327	13
2010-2007; OE Equivalent Fuel Cap .....	10834		2004-2000; OE Type Radiator Cap .....	10227	13
2010-2007; Regular Locking Fuel Cap .....	10504		2004-2000; OE Equivalent Fuel Cap .....	10834	
2010-2007; Oil Filler Cap .....	10135		2004-2000; Regular Locking Fuel Cap .....	10504	
<b>Solara</b>			2004-2000; Oil Filler Cap .....	10080	
<b>4-Cyl. 2.2 L</b>			1999; Lev-R-Vent Radiator Cap .....	✓10327	13
2001; OE Type Radiator Cap .....	10241	13			

✓ Check Hood Clearance prior to installing this Cap.

## Caps for Passenger Cars and Light Trucks (1990 and Newer)

Application	Part Number	PSI	Application	Part Number	PSI
<b>Toyota - Continued</b>			<b>Toyota - Continued</b>		
<b>Tacoma - Continued</b>			<b>Tercel</b>		
<b>4-Cyl. 2.4 L - Continued</b>			<b>4-Cyl. 1.5 L</b>		
1999: OE Type Radiator Cap .....	10227	13	1998-1995: OE Type Radiator Cap .....	10241	13
1999: OE Equivalent Fuel Cap; Models made in USA.; Early .....	10825		1998-1995: OE Equivalent Fuel Cap .....	10825	
1999: Regular Locking Fuel Cap; Models made in USA.; Early ..	10595		1998-1995: Regular Locking Fuel Cap .....	10595	
1999: Oil Filler Cap .....	10080		1998-1995: Oil Filler Cap .....	10080	
1998-1995: Lev-R-Vent Radiator Cap .....	✓10327	13	<b>Tundra</b>		
1998-1995: OE Type Radiator Cap .....	10227	13	<b>V-6 3.4 L</b>		
1998-1995: OE Equivalent Fuel Cap .....	10825		2004-2003: OE Type Radiator Cap .....	10241	13
1998-1995: Regular Locking Fuel Cap .....	10595		2004-2003: OE Equivalent Fuel Cap .....	10839	
1998-1995: Oil Filler Cap .....	10080		2004-2003: Regular Locking Fuel Cap .....	10509	
<b>4-Cyl. 2.7 L</b>			2004-2003: Oil Filler Cap .....	10080	
2012: OE Equivalent Fuel Cap .....	10834		2002-2000: OE Type Radiator Cap .....	10241	13
2012: Regular Locking Fuel Cap .....	10504		2002-2000: OE Equivalent Fuel Cap .....	10834	
2011: OE Type Radiator Cap .....	10242	16	2002-2000: Regular Locking Fuel Cap .....	10504	
2011: OE Equivalent Fuel Cap .....	10834		2002-2000: Oil Filler Cap .....	10080	
2011: Regular Locking Fuel Cap .....	10504		<b>V-6 4.0 L</b>		
2010-2009: OE Type Radiator Cap .....	10242	16	2012: OE Equivalent Fuel Cap .....	10834	
2010-2009: OE Equivalent Fuel Cap .....	10834		2012: Regular Locking Fuel Cap .....	10504	
2010-2009: Regular Locking Fuel Cap .....	10504		2011-2010: OE Type Radiator Cap .....	10242	16
2010-2009: Oil Filler Cap .....	10135		2011-2010: OE Equivalent Fuel Cap .....	10834	
2008-2005: OE Type Radiator Cap .....	10242	16	2011-2010: Regular Locking Fuel Cap .....	10504	
2008-2005: OE Equivalent Fuel Cap .....	10839		2011-2010: Oil Filler Cap .....	10080	
2008-2005: Regular Locking Fuel Cap .....	10509		2009-2007: OE Type Radiator Cap .....	10242	16
2008-2005: Oil Filler Cap .....	10135		2009-2007: OE Equivalent Fuel Cap .....	10834	
2004-2000: Lev-R-Vent Radiator Cap .....	✓10327	13	2009-2007: Regular Locking Fuel Cap .....	10504	
2004-2000: OE Type Radiator Cap .....	10227	13	2009-2007: Oil Filler Cap .....	10135	
2004-2000: OE Equivalent Fuel Cap .....	10834		2006-2005: OE Type Radiator Cap .....	10241	13
2004-2000: Regular Locking Fuel Cap .....	10504		2006-2005: OE Equivalent Fuel Cap .....	10839	
2004-2000: Oil Filler Cap .....	10080		2006-2005: Regular Locking Fuel Cap .....	10509	
1999: Lev-R-Vent Radiator Cap .....	✓10327	13	2006-2005: Oil Filler Cap .....	10135	
1999: OE Type Radiator Cap .....	10227	13	<b>V-8 4.6 L</b>		
1999: OE Equivalent Fuel Cap; Models made in USA.; Early .....	10825		2012: OE Equivalent Fuel Cap .....	10834	
1999: Regular Locking Fuel Cap; Models made in USA.; Early ..	10595		2012: Regular Locking Fuel Cap .....	10504	
1999: Oil Filler Cap .....	10080		2011: OE Type Radiator Cap .....	10242	16
1998-1995: Lev-R-Vent Radiator Cap .....	✓10327	13	2011: OE Equivalent Fuel Cap .....	10834	
1998-1995: OE Type Radiator Cap .....	10227	13	2011: Regular Locking Fuel Cap .....	10504	
1998-1995: OE Equivalent Fuel Cap .....	10825		2010: OE Type Radiator Cap .....	10242	16
1998-1995: Regular Locking Fuel Cap .....	10595		2010: OE Equivalent Fuel Cap .....	10834	
1998-1995: Oil Filler Cap .....	10080		2010: Regular Locking Fuel Cap .....	10504	
<b>V-6 3.4 L</b>			2010: Oil Filler Cap .....	10135	
2004-2000: Lev-R-Vent Radiator Cap .....	✓10327	13	<b>V-8 4.7 L</b>		
2004-2000: OE Type Radiator Cap .....	10227	13	2009: OE Type Radiator Cap .....	10242	16
2004-2000: OE Equivalent Fuel Cap .....	10834		2009: OE Equivalent Fuel Cap .....	10834	
2004-2000: Regular Locking Fuel Cap .....	10504		2009: Regular Locking Fuel Cap .....	10504	
2004-2000: Oil Filler Cap .....	10080		2008-2007: OE Type Radiator Cap .....	10242	16
1999: Lev-R-Vent Radiator Cap .....	✓10327	13	2008-2007: OE Equivalent Fuel Cap .....	10834	
1999: OE Type Radiator Cap .....	10227	13	2008-2007: Regular Locking Fuel Cap .....	10504	
1999: OE Equivalent Fuel Cap; Models made in USA.; Early .....	10825		2008-2007: Oil Filler Cap .....	10080	
1999: Regular Locking Fuel Cap; Models made in USA.; Early ..	10595		2006-2003: OE Type Radiator Cap .....	10241	13
1999: Oil Filler Cap .....	10080		2006-2003: OE Equivalent Fuel Cap .....	10839	
1998-1995: Lev-R-Vent Radiator Cap .....	✓10327	13	2006-2003: Regular Locking Fuel Cap .....	10509	
1998-1995: OE Type Radiator Cap .....	10227	13	2006-2003: Oil Filler Cap .....	10080	
1998-1995: OE Equivalent Fuel Cap .....	10825		2002-2000: OE Type Radiator Cap .....	10241	13
1998-1995: Regular Locking Fuel Cap .....	10595		2002-2000: OE Equivalent Fuel Cap .....	10834	
1998-1995: Oil Filler Cap .....	10080		2002-2000: Regular Locking Fuel Cap .....	10504	
<b>V-6 4.0 L</b>			2002-2000: Oil Filler Cap .....	10080	
2012: OE Equivalent Fuel Cap .....	10834		<b>V-8 5.7 L</b>		
2012: Regular Locking Fuel Cap .....	10504		2012: OE Equivalent Fuel Cap .....	10834	
2011: OE Type Radiator Cap .....	10242	16	2012: Flex Fuel Regular Fuel Cap .....	10834Y	
2011: OE Equivalent Fuel Cap .....	10834		2012: Regular Locking Fuel Cap .....	10504	
2011: Regular Locking Fuel Cap .....	10504		2012: Flex Fuel Regular Locking Fuel Cap .....	10504Y	
2010: OE Type Radiator Cap .....	10242	16	2011: OE Type Radiator Cap .....	10242	16
2010: OE Equivalent Fuel Cap .....	10834		2011: OE Equivalent Fuel Cap .....	10834	
2010: Regular Locking Fuel Cap .....	10504		2011: Flex Fuel Regular Fuel Cap .....	10834Y	
2010: Oil Filler Cap .....	10080		2011: Regular Locking Fuel Cap .....	10504	
2009: OE Type Radiator Cap .....	10242	16	2011: Flex Fuel Regular Locking Fuel Cap .....	10504Y	
2009: OE Equivalent Fuel Cap .....	10834		2011: Oil Filler Cap .....	10135	
2009: Regular Locking Fuel Cap .....	10504		2010: OE Type Radiator Cap .....	10242	16
2009: Oil Filler Cap .....	10135		2010: OE Equivalent Fuel Cap .....	10834	
2008-2005: OE Type Radiator Cap .....	10242	16	2010: Regular Locking Fuel Cap .....	10504	
2008-2005: OE Equivalent Fuel Cap .....	10839		2010: Flex Fuel Regular Fuel Cap .....	10834Y	
2008-2005: Regular Locking Fuel Cap .....	10509		2010: Flex Fuel Regular Locking Fuel Cap .....	10504Y	
2008-2005: Oil Filler Cap .....	10135				

✓ Check Hood Clearance prior to installing this Cap.

## Caps for Passenger Cars and Light Trucks (1990 and Newer)

Application	Part Number	PSI	Application	Part Number	PSI
<b>Toyota - Continued</b>			<b>Volkswagen - Continued</b>		
<b>Tundra - Continued</b>			<b>Beetle - Continued</b>		
<b>V-8 5.7 L - Continued</b>			<b>4-Cyl. 2.0 L</b>		
2010: Oil Filler Cap .....	10135		2005-2004: OE Type Radiator Cap .....	10249	22
2009: OE Type Radiator Cap .....	10242	16	2005-2004: OE Equivalent Fuel Cap; OE Has Tether .....	10827	
2009: OE Equivalent Fuel Cap .....	10834		2005-2004: Regular Locking Fuel Cap; OE Has Tether .....	10507	
2009: Flex Fuel Regular Fuel Cap .....	10834Y		2005-2004: OE Equivalent Fuel Cap; No OE Tether .....	10835	
2009: Regular Locking Fuel Cap .....	10504		2005-2004: Regular Locking Fuel Cap; No OE Tether .....	10505	
2009: Flex Fuel Regular Locking Fuel Cap .....	10504Y		2005-2004: Oil Filler Cap .....	10079	
2009: Oil Filler Cap .....	10135		2003-1998: OE Type Radiator Cap .....	10249	22
2008-2007: OE Type Radiator Cap .....	10242	16	2003-1998: OE Equivalent Fuel Cap .....	10835	
2008-2007: OE Equivalent Fuel Cap .....	10834		2003-1998: Regular Locking Fuel Cap .....	10505	
2008-2007: Regular Locking Fuel Cap .....	10504		2003-1998: Oil Filler Cap .....	10079	
2008-2007: Oil Filler Cap .....	10135		<b>5-Cyl. 2.5 L</b>		
<b>Venza</b>			2010: OE Type Radiator Cap .....		
4-Cyl. 2.7 L			2010: OE Equivalent Fuel Cap .....		
2011: OE Type Radiator Cap .....	10242	16	2010: Regular Locking Fuel Cap .....	10505	
2011: OE Equivalent Fuel Cap .....	10834		2010: Oil Filler Cap .....	10079	
2011: Regular Locking Fuel Cap .....	10504		2009: OE Type Radiator Cap .....	10249	22
2011: Oil Filler Cap .....	10135		2009: OE Equivalent Fuel Cap .....	10835	
2010: OE Type Radiator Cap .....	10242	16	2009: Regular Locking Fuel Cap .....	10505	
2010: Oil Filler Cap .....	10135		2008: OE Type Radiator Cap .....	10249	22
2009: OE Type Radiator Cap .....	10242	16	2008: Oil Filler Cap .....	10079	
2009: OE Equivalent Fuel Cap .....	10834		2007-2006: OE Type Radiator Cap .....	10249	22
2009: Regular Locking Fuel Cap .....	10504		2007-2006: OE Equivalent Fuel Cap .....	10827	
2009: Oil Filler Cap .....	10135		2007-2006: Regular Locking Fuel Cap .....	10597	
<b>V-6 3.5 L</b>			2007-2006: Oil Filler Cap .....		
2011: OE Type Radiator Cap .....	10242	16	<b>Cabrio</b>		
2011: OE Equivalent Fuel Cap .....	10834		4-Cyl. 2.0 L		
2011: Regular Locking Fuel Cap .....	10504		2002-1995: OE Type Radiator Cap .....		
2011: Oil Filler Cap .....	10080		2002-1995: OE Equivalent Fuel Cap .....		
2010: OE Type Radiator Cap .....	10242	16	2002-1995: Regular Locking Fuel Cap .....		
2010: Oil Filler Cap .....	10080		2002-1995: Oil Filler Cap .....		
2009: OE Type Radiator Cap .....	10242	16	<b>CC</b>		
2009: OE Equivalent Fuel Cap .....	10834		4-Cyl. 2.0 L		
2009: Regular Locking Fuel Cap .....	10504		2011-2009: OE Type Radiator Cap .....		
2009: Oil Filler Cap; Models made in Japan. ....	10080		2010-2009: OE Type Radiator Cap .....		
2009: Oil Filler Cap; Models made in USA. ....	10135		2010-2009: Oil Filler Cap .....		
<b>Yaris</b>			<b>Eos</b>		
4-Cyl. 1.5 L			4-Cyl. 2.0 L		
2011-2007: OE Type Radiator Cap .....	10242	16	2011-2007: OE Type Radiator Cap .....		
2011-2007: OE Equivalent Fuel Cap .....	10834		2011-2007: OE Type Radiator Cap .....		
2011-2007: Regular Locking Fuel Cap .....	10504		2011-2007: OE Type Radiator Cap .....		
2011-2007: Oil Filler Cap .....	10135		2011-2007: OE Type Radiator Cap .....		
<b>Volkswagen</b>			<b>V-6 3.6 L</b>		
<b>Beetle</b>			2010-2009: OE Type Radiator Cap .....		
4-Cyl. 1.8 L			2010-2009: Oil Filler Cap .....		
2005-2004: OE Type Radiator Cap .....	10249	22	<b>Eurovan</b>		
2005-2004: OE Equivalent Fuel Cap; OE Has Tether .....	10827		5-Cyl. 2.5 L		
2005-2004: Regular Locking Fuel Cap; OE Has Tether .....	10507		1996-1995: OE Type Radiator Cap .....		
2005-2004: OE Equivalent Fuel Cap; No OE Tether .....	10835		1996-1995: OE Type Radiator Cap .....		
2005-2004: Regular Locking Fuel Cap; No OE Tether .....	10505		1996-1995: OE Type Radiator Cap .....		
2005-2004: Oil Filler Cap .....	10079		1996-1995: OE Type Radiator Cap .....		
2003-1999: OE Type Radiator Cap .....	10249	22	1996-1995: OE Type Radiator Cap .....		
2003-1999: OE Equivalent Fuel Cap .....	10835		1996-1995: OE Type Radiator Cap .....		
2003-1999: Regular Locking Fuel Cap .....	10505		1996-1995: OE Type Radiator Cap .....		
2003-1999: Oil Filler Cap .....	10079		1996-1995: OE Type Radiator Cap .....		
4-Cyl. 1.9 L Diesel			1996-1995: OE Type Radiator Cap .....		
2006: OE Type Radiator Cap .....	10249	22	1996-1995: OE Type Radiator Cap .....		
2006: Oil Filler Cap .....	10079		1996-1995: OE Type Radiator Cap .....		
2005-2004: OE Type Radiator Cap .....	10249	22	1996-1995: OE Type Radiator Cap .....		
2005-2004: OE Equivalent Fuel Cap; OE Has Tether .....	10827		1996-1995: OE Type Radiator Cap .....		
2005-2004: Regular Locking Fuel Cap; OE Has Tether .....	10507		1996-1995: OE Type Radiator Cap .....		
2005-2004: OE Equivalent Fuel Cap; No OE Tether .....	10835		1996-1995: OE Type Radiator Cap .....		
2005-2004: Regular Locking Fuel Cap; No OE Tether .....	10505		1996-1995: OE Type Radiator Cap .....		
2005-2004: Oil Filler Cap .....	10079		1996-1995: OE Type Radiator Cap .....		
2003-1998: OE Type Radiator Cap .....	10249	22	1996-1995: OE Type Radiator Cap .....		
2003-1998: OE Equivalent Fuel Cap .....	10835		1996-1995: OE Type Radiator Cap .....		
2003-1998: Regular Locking Fuel Cap .....	10505		1996-1995: OE Type Radiator Cap .....		
2003-1998: Oil Filler Cap .....	10079		1996-1995: OE Type Radiator Cap .....		
<b>Volkswagen - Continued</b>			<b>Golf</b>		
<b>Beetle - Continued</b>			4-Cyl. 1.8 L		
4-Cyl. 2.0 L			2006: OE Type Radiator Cap .....		
2005-2004: OE Type Radiator Cap .....			2006: OE Equivalent Fuel Cap .....		
2005-2004: OE Equivalent Fuel Cap; OE Has Tether .....			2006: Regular Locking Fuel Cap .....		
2005-2004: Regular Locking Fuel Cap; OE Has Tether .....			2006: Oil Filler Cap .....		
2005-2004: OE Equivalent Fuel Cap; No OE Tether .....			2005: OE Type Radiator Cap .....		
2005-2004: Regular Locking Fuel Cap; No OE Tether .....			2005: OE Equivalent Fuel Cap; W/Central Locking Fuel Cap .....		
2005-2004: Oil Filler Cap .....			2005: Regular Locking Fuel Cap; W/Central Locking Fuel Cap .....		
2003-1998: OE Type Radiator Cap .....					
2003-1998: OE Equivalent Fuel Cap .....					
2003-1998: Regular Locking Fuel Cap .....					
2003-1998: Oil Filler Cap .....					

## Caps for Passenger Cars and Light Trucks (1990 and Newer)

Application	Part Number	PSI	Application	Part Number	PSI
<b>Volkswagen - Continued</b>			<b>Volkswagen - Continued</b>		
<b>Golf - Continued</b>			<b>Golf - Continued</b>		
<b>4-Cyl. 1.8 L - Continued</b>			<b>5-Cyl. 2.5 L - Continued</b>		
2005; OE Equivalent Fuel Cap; W/O Central Locking Fuel Cap ..	10827		2010; OE Type Radiator Cap .....	10249	22
2005; Regular Locking Fuel Cap; W/O Central Locking Fuel Cap	10597		2010; OE Equivalent Fuel Cap .....	10827	
2005; Oil Filler Cap .....	10079		2010; Regular Locking Fuel Cap .....	10595	
2004-2000; OE Type Radiator Cap .....	10249	22	2010; Oil Filler Cap .....	10079	
2004-2000; OE Equivalent Fuel Cap .....	10835				
2004-2000; Regular Locking Fuel Cap .....	10505		<b>V-6 2.8 L</b>		
2004-2000; Oil Filler Cap .....	10079		2005; OE Type Radiator Cap .....	10249	22
			2005; OE Equivalent Fuel Cap; W/Central Locking Fuel Cap .....	10835	
<b>4-Cyl. 1.8 L (Canada)</b>			2005; Regular Locking Fuel Cap; W/Central Locking Fuel Cap ..	10505	
1997; OE Type Radiator Cap .....	10243	20	2005; OE Equivalent Fuel Cap; W/O Central Locking Fuel Cap ..	10827	
1997; OE Equivalent Fuel Cap .....	10835		2005; Regular Locking Fuel Cap; W/O Central Locking Fuel Cap	10597	
1997; Regular Locking Fuel Cap .....	10505		2005; Oil Filler Cap .....	10079	
1997; Oil Filler Cap .....	10079		2004-2000; OE Type Radiator Cap .....	10249	22
			2004-2000; OE Equivalent Fuel Cap .....	10835	
<b>4-Cyl. 1.9 L Diesel</b>			2004-2000; Regular Locking Fuel Cap .....	10505	
2006; OE Type Radiator Cap .....	10249	22	2004-2000; Oil Filler Cap .....	10079	
2006; OE Equivalent Fuel Cap .....	10835		1999-1995; OE Type Radiator Cap .....	10243	20
2006; Regular Locking Fuel Cap .....	10505		1999-1995; OE Equivalent Fuel Cap .....	10835	
2006; Oil Filler Cap .....	10079		1999-1995; Regular Locking Fuel Cap .....	10505	
2005-2004; OE Type Radiator Cap .....	10249	22	1999-1995; Oil Filler Cap .....	10079	
2005-2004; OE Equivalent Fuel Cap; W/Central Locking Fuel					
Cap .....	10835		<b>V-6 3.2 L</b>		
2005-2004; Regular Locking Fuel Cap; W/Central Locking Fuel			2004; OE Type Radiator Cap .....	10249	22
Cap .....	10505		2004; OE Equivalent Fuel Cap .....	10835	
2005-2004; OE Equivalent Fuel Cap; W/O Central Locking Fuel			2004; Regular Locking Fuel Cap .....	10505	
Cap .....	10827				
2005-2004; Regular Locking Fuel Cap; W/O Central Locking Fuel			<b>GTI</b>		
Cap .....	10597				
2005-2004; Oil Filler Cap .....	10079		<b>4-Cyl. 2.0 L</b>		
2003-1999; OE Type Radiator Cap .....	10249	22	2011-2008; OE Type Radiator Cap .....	10249	22
2003-1999; OE Equivalent Fuel Cap .....	10835		2011-2008; OE Equivalent Fuel Cap .....	10827	
2003-1999; Regular Locking Fuel Cap .....	10505		2011-2008; Regular Locking Fuel Cap .....	10597	
2003-1999; Oil Filler Cap .....	10079		2007-2006; OE Type Radiator Cap .....	10249	22
			2007-2006; OE Equivalent Fuel Cap .....	10835	
<b>4-Cyl. 1.9 L Diesel (Canada)</b>			2007-2006; Regular Locking Fuel Cap .....	10505	
1998-1997; OE Equivalent Fuel Cap .....	10835		2007-2006; Oil Filler Cap .....	10079	
1998-1997; Regular Locking Fuel Cap .....	10505				
			<b>Jetta</b>		
<b>4-Cyl. 2.0 L</b>					
2006; OE Type Radiator Cap .....	10249	22	<b>4-Cyl. 1.8 L</b>		
2006; OE Equivalent Fuel Cap .....	10835		2005-2002; OE Type Radiator Cap .....	10249	22
2006; Regular Locking Fuel Cap .....	10505		2005-2002; OE Equivalent Fuel Cap; W/Central Locking Fuel		
2006; Oil Filler Cap .....	10079		Cap .....	10835	
2005-2004; OE Type Radiator Cap .....	10249	22	2005-2002; Regular Locking Fuel Cap; W/Central Locking Fuel		
2005-2004; OE Equivalent Fuel Cap; W/Central Locking Fuel			Cap .....	10505	
Cap .....	10835		2005-2002; OE Equivalent Fuel Cap; W/O Central Locking Fuel		
2005-2004; Regular Locking Fuel Cap; W/Central Locking Fuel			Cap .....	10827	
Cap .....	10505		2005-2002; Regular Locking Fuel Cap; W/O Central Locking Fuel		
2005-2004; OE Equivalent Fuel Cap; W/O Central Locking Fuel			Cap .....	10597	
Cap .....	10827		2005-2002; Oil Filler Cap .....	10079	
2005-2004; Regular Locking Fuel Cap; W/O Central Locking Fuel			2001-2000; OE Type Radiator Cap .....	10249	22
Cap .....	10597		2001-2000; OE Equivalent Fuel Cap .....	10835	
2005-2004; Oil Filler Cap .....	10079		2001-2000; Regular Locking Fuel Cap .....	10505	
2003-2000; OE Type Radiator Cap .....	10249	22	2001-2000; Oil Filler Cap .....	10079	
2003-2000; OE Equivalent Fuel Cap .....	10835				
2003-2000; Regular Locking Fuel Cap .....	10505		<b>4-Cyl. 1.9 L Diesel</b>		
2003-2000; Oil Filler Cap .....	10079		2006; OE Type Radiator Cap .....	10249	22
1999-1995; OE Type Radiator Cap .....	10243	20	2006; OE Equivalent Fuel Cap .....	10835	
1999-1995; OE Equivalent Fuel Cap .....	10835		2006; Regular Locking Fuel Cap .....	10505	
1999-1995; Regular Locking Fuel Cap .....	10505		2005-2002; OE Type Radiator Cap .....	10249	22
1999-1995; Oil Filler Cap .....	10079		2005-2002; OE Equivalent Fuel Cap; W/Central Locking Fuel		
			Cap .....	10835	
<b>4-Cyl. 2.0 L (Canada)</b>			2005-2002; Regular Locking Fuel Cap; W/Central Locking Fuel		
2007; OE Type Radiator Cap .....	10249	22	Cap .....	10505	
2007; OE Equivalent Fuel Cap .....	10835		2005-2002; OE Equivalent Fuel Cap; W/O Central Locking Fuel		
2007; Regular Locking Fuel Cap .....	10505		Cap .....	10827	
2007; Oil Filler Cap .....	10079		2005-2002; Regular Locking Fuel Cap; W/O Central Locking Fuel		
			Cap .....	10597	
<b>4-Cyl. 2.0 L Diesel</b>			2005-2002; Oil Filler Cap .....	10079	
2012-2011; OE Type Radiator Cap .....	10249	22	2001-2000; OE Type Radiator Cap .....	10249	22
2010; OE Type Radiator Cap .....	10249	22	2001-2000; OE Equivalent Fuel Cap .....	10835	
2010; OE Equivalent Fuel Cap .....	10834		2001-2000; Regular Locking Fuel Cap .....	10505	
2010; Regular Locking Fuel Cap .....	10504		2001-2000; Oil Filler Cap .....	10079	
			1999; OE Type Radiator Cap .....	10243	20
<b>5-Cyl. 2.5 L</b>			1999; OE Equivalent Fuel Cap .....	10835	
2011; OE Type Radiator Cap .....	10249	22	1999; Regular Locking Fuel Cap .....	10505	
2011; OE Equivalent Fuel Cap .....	10827		1999; Oil Filler Cap .....	10079	
2011; Regular Locking Fuel Cap .....	10597				

## Caps for Passenger Cars and Light Trucks (1990 and Newer)

Application	Part Number	PSI	Application	Part Number	PSI
<b>Volkswagen - Continued</b>			<b>Volkswagen - Continued</b>		
<b>Jetta - Continued</b>			<b>Jetta - Continued</b>		
<b>4-Cyl. 1.9 L Diesel - Continued</b>			<b>V-6 2.8 L - Continued</b>		
1998-1997; OE Type Radiator Cap .....	10243	20	1998-1995; Oil Filler Cap .....	10079	
1998-1997; OE Equivalent Fuel Cap .....	10835		<b>Passat</b>		
1998-1997; Regular Locking Fuel Cap .....	10505		<b>4-Cyl. 1.8 L</b>		
<b>4-Cyl. 2.0 L</b>			2005-1998; OE Type Radiator Cap .....		
2011; OE Type Radiator Cap .....	10249	22	2005-1998; OE Equivalent Fuel Cap .....	10835	22
2010; OE Type Radiator Cap .....	10249	22	2005-1998; Regular Locking Fuel Cap .....	10505	
2010; OE Equivalent Fuel Cap .....	10827		2005-1998; Oil Filler Cap .....	10079	
2010; Regular Locking Fuel Cap .....	10597		<b>4-Cyl. 1.9 L Diesel</b>		
2009; OE Type Radiator Cap .....	10249	22	1998; OE Type Radiator Cap .....	10249	22
2008-2006; OE Type Radiator Cap .....	10249	22	1998; OE Equivalent Fuel Cap .....	10835	
2008-2006; OE Equivalent Fuel Cap .....	10827		1998; Regular Locking Fuel Cap .....	10505	
2008-2006; Regular Locking Fuel Cap .....	10597		1998; Oil Filler Cap .....	10079	
2008-2006; Oil Filler Cap .....	10079		1997-1996; OE Type Radiator Cap .....	10243	20
2005-2003; OE Type Radiator Cap .....	10249	22	1997-1996; OE Equivalent Fuel Cap .....	10835	
2005-2003; OE Equivalent Fuel Cap; W/Central Locking Fuel Cap .....	10835		1997-1996; Regular Locking Fuel Cap .....	10505	
2005-2003; Regular Locking Fuel Cap; W/Central Locking Fuel Cap .....	10505		1997-1996; Oil Filler Cap .....	10079	
2005-2003; OE Equivalent Fuel Cap; W/O Central Locking Fuel Cap .....	10827		<b>4-Cyl. 2.0 L</b>		
2005-2003; Regular Locking Fuel Cap; W/O Central Locking Fuel Cap .....	10597		2010; OE Type Radiator Cap .....	10249	22
2005-2003; Oil Filler Cap .....	10079		2008-2006; OE Type Radiator Cap .....	10249	22
2002; OE Type Radiator Cap; W/Central Locking Fuel Cap .....	10249	22	1996; OE Type Radiator Cap .....	10243	20
2002; OE Equivalent Fuel Cap; W/Central Locking Fuel Cap .....	10835		1996; OE Equivalent Fuel Cap .....	10835	
2002; Regular Locking Fuel Cap; W/Central Locking Fuel Cap .....	10505		1996; Regular Locking Fuel Cap .....	10505	
2002; OE Equivalent Fuel Cap; W/O Central Locking Fuel Cap .....	10827		1996; Oil Filler Cap .....	10079	
2002; Regular Locking Fuel Cap; W/O Central Locking Fuel Cap .....	10597		1995; OE Equivalent Fuel Cap .....	10835	
2002; Oil Filler Cap .....	10079		1995; Regular Locking Fuel Cap .....	10505	
2001-2000; OE Type Radiator Cap .....	10249	22	<b>4-Cyl. 2.0 L Diesel</b>		
2001-2000; OE Equivalent Fuel Cap .....	10835		2005; OE Type Radiator Cap .....	10249	22
2001-2000; Regular Locking Fuel Cap .....	10505		2005; OE Equivalent Fuel Cap .....	10835	
2001-2000; Oil Filler Cap .....	10079		2005; Regular Locking Fuel Cap .....	10505	
1999-1995; OE Type Radiator Cap .....	10243	20	2004; OE Type Radiator Cap .....	10249	22
1999-1995; OE Equivalent Fuel Cap .....	10835		2004; OE Equivalent Fuel Cap .....	10835	
1999-1995; Regular Locking Fuel Cap .....	10505		2004; Regular Locking Fuel Cap .....	10505	
1999-1995; Oil Filler Cap .....	10079		2004; Oil Filler Cap .....	10079	
<b>4-Cyl. 2.0 L Diesel</b>			<b>V-6 2.8 L</b>		
2011; OE Type Radiator Cap .....	10249	22	2005; OE Type Radiator Cap .....	10249	22
2010-2009; OE Type Radiator Cap .....	10249	22	2005; OE Equivalent Fuel Cap .....	10835	
2010-2009; OE Equivalent Fuel Cap .....	10834		2005; Regular Locking Fuel Cap .....	10505	
2010-2009; Regular Locking Fuel Cap .....	10504		2005; Oil Filler Cap .....	10130	
<b>5-Cyl. 2.5 L</b>			2004-1998; OE Type Radiator Cap .....	10249	22
2011; OE Type Radiator Cap .....	10249	22	2004-1998; OE Equivalent Fuel Cap .....	10835	
2011; OE Equivalent Fuel Cap .....	10827		2004-1998; Regular Locking Fuel Cap .....	10505	
2011; Regular Locking Fuel Cap .....	10597		2004-1998; Oil Filler Cap .....	10079	
2010; OE Type Radiator Cap .....	10249	22	1997-1995; OE Type Radiator Cap .....	10243	20
2010; OE Equivalent Fuel Cap .....	10827		1997-1995; OE Equivalent Fuel Cap .....	10835	
2010; Regular Locking Fuel Cap .....	10595		1997-1995; Regular Locking Fuel Cap .....	10505	
2010; Oil Filler Cap .....	10079		1997-1995; Oil Filler Cap .....	10079	
2009-2005; OE Type Radiator Cap .....	10249	22	<b>V-6 3.6 L</b>		
2009-2005; OE Equivalent Fuel Cap .....	10827		2008-2006; OE Type Radiator Cap .....	10249	22
2009-2005; Regular Locking Fuel Cap .....	10597		2008-2006; Oil Filler Cap .....	10079	
2009-2005; Oil Filler Cap .....	10079		<b>W-8 4.0 L</b>		
<b>V-6 2.8 L</b>			2004-2002; OE Type Radiator Cap .....	10249	22
2004-2002; OE Type Radiator Cap .....	10249	22	2004-2002; OE Equivalent Fuel Cap .....	10835	
2004-2002; OE Equivalent Fuel Cap; W/Central Locking Fuel Cap .....	10835		2004-2002; Regular Locking Fuel Cap .....	10505	
2004-2002; Regular Locking Fuel Cap; W/Central Locking Fuel Cap .....	10505		2004-2002; Oil Filler Cap .....	10079	
2004-2002; OE Equivalent Fuel Cap; W/O Central Locking Fuel Cap .....	10827		<b>Phaeton</b>		
2004-2002; Regular Locking Fuel Cap; W/O Central Locking Fuel Cap .....	10597		<b>V-8 4.2 L</b>		
2004-2002; Oil Filler Cap .....	10079		2006-2004; OE Equivalent Fuel Cap .....	10827	
2001-1999; OE Type Radiator Cap .....	10249	22	2006-2004; Regular Locking Fuel Cap .....	10597	
2001-1999; OE Equivalent Fuel Cap .....	10835		<b>W-12 6.0 L</b>		
2001-1999; Regular Locking Fuel Cap .....	10505		2006-2004; OE Equivalent Fuel Cap .....	10827	
2001-1999; Oil Filler Cap .....	10079		2006-2004; Regular Locking Fuel Cap .....	10597	
1998-1995; OE Type Radiator Cap .....	10243	20	2006-2004; Oil Filler Cap .....	10079	
1998-1995; OE Equivalent Fuel Cap .....	10835		<b>R32</b>		
1998-1995; Regular Locking Fuel Cap .....	10505		<b>V-6 3.2 L</b>		
			2008; OE Type Radiator Cap .....	10249	22
			2008; OE Equivalent Fuel Cap .....	10827	
			2008; Regular Locking Fuel Cap .....	10597	
			2008; Oil Filler Cap .....	10079	

## Caps for Passenger Cars and Light Trucks (1990 and Newer)

Application	Part Number	PSI	Application	Part Number	PSI
<b>Volkswagen - Continued</b>			<b>Volkswagen - Continued</b>		
<b>Rabbit</b>			<b>Touareg 2 - Continued</b>		
<b>5-Cyl. 2.5 L</b>			<b>V-6 3.6 L - Continued</b>		
2009-2006; OE Type Radiator Cap .....	10249	22	2010-2008; Oil Filler Cap .....	10079	
2009-2006; OE Equivalent Fuel Cap .....	10827		<b>V-8 4.2 L</b>		
2009-2006; Regular Locking Fuel Cap .....	10597		2009; OE Type Radiator Cap .....	10249	22
2009-2006; Oil Filler Cap .....	10079		2009; OE Equivalent Fuel Cap .....	10826	
<b>Routan</b>			2009; Regular Locking Fuel Cap .....	10596	
<b>V-6 3.6 L</b>			2008; OE Type Radiator Cap .....	10249	22
2011; OE Equivalent Fuel Cap .....	10838		2008; OE Equivalent Fuel Cap .....	10826	
2011; Regular Locking Fuel Cap .....	10508		2008; Regular Locking Fuel Cap .....	10596	
2011; Flex Fuel Regular Fuel Cap .....	10838Y		2008; Oil Filler Cap .....	10079	
2011; Flex Fuel Regular Locking Fuel Cap .....	10508Y		<b>Volvo</b>		
<b>V-6 3.8 L; V-6 4.0 L</b>			<b>850</b>		
2010-2009; OE Equivalent Fuel Cap .....	10838		<b>5-Cyl. 2.3 L; 5-Cyl. 2.4 L</b>		
2010-2009; Regular Locking Fuel Cap .....	10508		1997-1995; OE Type Radiator Cap .....	10244	22
2010-2009; Oil Filler Cap .....	10111		1997-1995; OE Equivalent Fuel Cap .....	10817	
<b>Tiguan</b>			1997-1995; Pre-Vent Non-Locking Fuel Cap .....	10819	
<b>4-Cyl. 2.0 L</b>			1997-1995; Regular Locking Fuel Cap .....	10591	
2009; OE Type Radiator Cap .....	10249	22	1997-1995; Pre-Vent Locking Fuel Cap .....	10501	
<b>Touareg</b>			1997-1995; Oil Filler Cap .....	10129	
<b>V-10 5.0 L Diesel</b>			<b>940</b>		
2007; OE Type Radiator Cap .....	10249	22	<b>4-Cyl. 2.3 L</b>		
2007; OE Equivalent Fuel Cap .....	10835		1995; OE Type Radiator Cap .....	10244	22
2007; Regular Locking Fuel Cap .....	10505		1995; OE Equivalent Fuel Cap .....	10817	
2007; Oil Filler Cap .....	10079		1995; Pre-Vent Non-Locking Fuel Cap .....	10819	
2006; OE Type Radiator Cap .....	10249	22	1995; Regular Locking Fuel Cap .....	10591	
2006; OE Equivalent Fuel Cap .....	10826		1995; Pre-Vent Locking Fuel Cap .....	10501	
2006; Regular Locking Fuel Cap .....	10596		1995; Oil Filler Cap .....	10129	
2005; OE Type Radiator Cap .....	10249	22	<b>960</b>		
2005; OE Equivalent Fuel Cap .....	10835		<b>6-Cyl. 2.9 L</b>		
2005; Regular Locking Fuel Cap .....	10505		1997-1995; OE Type Radiator Cap .....	10244	22
2005; Oil Filler Cap .....	10079		1997-1995; OE Equivalent Fuel Cap .....	10817	
2004; OE Type Radiator Cap .....	10242	16	1997-1995; Pre-Vent Non-Locking Fuel Cap .....	10819	
<b>V-6 3.2 L</b>			1997-1995; Regular Locking Fuel Cap .....	10591	
2006-2004; OE Type Radiator Cap .....	10249	22	1997-1995; Pre-Vent Locking Fuel Cap .....	10501	
2006-2004; OE Equivalent Fuel Cap .....	10826		1997-1995; Oil Filler Cap .....	10129	
2006-2004; Regular Locking Fuel Cap .....	10596		<b>C30</b>		
2006-2004; Oil Filler Cap .....	10079		<b>5-Cyl. 2.5 L</b>		
<b>V-6 3.6 L</b>			2011-2008; OE Type Radiator Cap .....	10262	21
2007; OE Type Radiator Cap .....	10249	22	2011-2008; OE Equivalent Fuel Cap .....	10851	
2007; OE Equivalent Fuel Cap .....	10826		2011-2008; Regular Locking Fuel Cap .....	10521	
2007; Regular Locking Fuel Cap .....	10596		<b>C70</b>		
2007; Oil Filler Cap .....	10079		<b>5-Cyl. 2.3 L</b>		
<b>V-8 4.2 L</b>			2004-1999; OE Type Radiator Cap .....	10244	22
2007; OE Type Radiator Cap .....	10249	22	2004-1999; OE Equivalent Fuel Cap .....	10834	
2007; OE Equivalent Fuel Cap .....	10826		2004-1999; Regular Locking Fuel Cap .....	10504	
2007; Regular Locking Fuel Cap .....	10596		2004-1999; Oil Filler Cap .....	10129	
2007; Oil Filler Cap .....	10079		1998; OE Type Radiator Cap .....	10244	22
2006-2004; OE Type Radiator Cap .....	10249	22	1998; OE Equivalent Fuel Cap .....	10817	
2006-2004; OE Equivalent Fuel Cap .....	10826		1998; Pre-Vent Non-Locking Fuel Cap .....	10819	
2006-2004; Regular Locking Fuel Cap .....	10596		1998; Regular Locking Fuel Cap .....	10591	
<b>Touareg 2</b>			1998; Pre-Vent Locking Fuel Cap .....	10501	
<b>V-10 5.0 L Diesel</b>			1998; Oil Filler Cap .....	10129	
2008; OE Type Radiator Cap .....	10249	22	<b>5-Cyl. 2.4 L</b>		
2008; OE Equivalent Fuel Cap .....	10826		2004-1998; OE Type Radiator Cap .....	10244	22
2008; Regular Locking Fuel Cap .....	10596		2004-1998; OE Equivalent Fuel Cap .....	10834	
2008; Oil Filler Cap .....	10079		2004-1998; Regular Locking Fuel Cap .....	10504	
<b>V-6 3.0 L Diesel</b>			2004-1998; Oil Filler Cap .....	10129	
2011; OE Type Radiator Cap .....	10249	22	<b>5-Cyl. 2.5 L</b>		
2010; OE Type Radiator Cap .....	10249	22	2011-2008; OE Type Radiator Cap .....	10262	21
2010; OE Equivalent Fuel Cap .....	10826		2011-2008; OE Equivalent Fuel Cap .....	10851	
2010; Regular Locking Fuel Cap .....	10596		2011-2008; Regular Locking Fuel Cap .....	10521	
<b>V-6 3.0 L Electric Assist</b>			2007-2006; OE Type Radiator Cap .....	10244	22
2011; OE Type Radiator Cap .....	10249	22	2007-2006; OE Equivalent Fuel Cap .....	10851	
<b>V-6 3.6 L</b>			2007-2006; Regular Locking Fuel Cap .....	10521	
2011; OE Type Radiator Cap .....	10249	22	2007-2006; Oil Filler Cap .....	10129	
2010-2008; OE Type Radiator Cap .....	10249	22			
2010-2008; OE Equivalent Fuel Cap .....	10826				
2010-2008; Regular Locking Fuel Cap .....	10596				



## Caps for Passenger Cars and Light Trucks (1990 and Newer)

Application	Part Number	PSI	Application	Part Number	PSI
<b>Volvo - Continued</b>			<b>Volvo - Continued</b>		
<b>S40</b>			<b>S70</b>		
<b>4-Cyl. 1.9 L</b>			<b>5-Cyl. 2.3 L</b>		
2004; OE Type Radiator Cap .....	10244	22	2000; OE Type Radiator Cap .....	10244	22
2004; OE Equivalent Fuel Cap .....	10834		2000; OE Equivalent Fuel Cap .....	10834	
2004; Regular Locking Fuel Cap .....	10504		2000; Regular Locking Fuel Cap .....	10504	
2004; Oil Filler Cap .....	10129		2000; Oil Filler Cap .....	10129	
2003-2002; OE Type Radiator Cap .....	10244	22	1999; OE Type Radiator Cap .....	10244	22
2003-2002; OE Equivalent Fuel Cap .....	10834		1999; Oil Filler Cap .....	10129	
2003-2002; Regular Locking Fuel Cap .....	10504		1998; OE Type Radiator Cap .....	10244	22
2001-2000; OE Type Radiator Cap .....	10244	22	1998; OE Equivalent Fuel Cap .....	10817	
2001-2000; OE Equivalent Fuel Cap .....	10834		1998; Pre-Vent Non-Locking Fuel Cap .....	10819	
2001-2000; Regular Locking Fuel Cap .....	10504		1998; Regular Locking Fuel Cap .....	10591	
2001-2000; Oil Filler Cap .....	10129		1998; Pre-Vent Locking Fuel Cap .....	10501	
<b>5-Cyl. 2.4 L</b>			<b>5-Cyl. 2.4 L</b>		
2010-2009; OE Type Radiator Cap .....	10262	21	2000-1999; OE Type Radiator Cap .....	10244	22
2010-2009; OE Equivalent Fuel Cap .....	10851		2000-1999; OE Equivalent Fuel Cap .....	10834	
2010-2009; Regular Locking Fuel Cap .....	10521		2000-1999; Regular Locking Fuel Cap .....	10504	
2008; OE Type Radiator Cap .....	10262	21	2000-1999; Oil Filler Cap .....	10129	
2008; OE Equivalent Fuel Cap .....	10851		1998; OE Type Radiator Cap .....	10244	22
2008; Regular Locking Fuel Cap .....	10521		1998; OE Equivalent Fuel Cap .....	10817	
2008; Oil Filler Cap .....	10129		1998; Pre-Vent Non-Locking Fuel Cap .....	10819	
2007; OE Type Radiator Cap .....	10244	22	1998; Regular Locking Fuel Cap .....	10591	
2007; OE Equivalent Fuel Cap .....	10834		1998; Pre-Vent Locking Fuel Cap .....	10501	
2007; Regular Locking Fuel Cap .....	10504		1998; Oil Filler Cap .....	10129	
2007; Oil Filler Cap .....	10129		<b>S80</b>		
2006-2004; OE Type Radiator Cap .....	10262	21	<b>5-Cyl. 2.5 L</b>		
2006-2004; OE Equivalent Fuel Cap .....	10851		2006-2004; OE Type Radiator Cap .....	10244	22
2006-2004; Regular Locking Fuel Cap .....	10521		2006-2004; OE Equivalent Fuel Cap .....	10834	
2006-2004; Oil Filler Cap .....	10129		2006-2004; Regular Locking Fuel Cap .....	10504	
<b>5-Cyl. 2.5 L</b>			2006-2004; Oil Filler Cap .....	10129	
2011-2009; OE Type Radiator Cap .....	10262	21	<b>6-Cyl. 2.8 L</b>		
2011-2009; OE Equivalent Fuel Cap .....	10851		2001-1999; OE Type Radiator Cap .....	10244	22
2011-2009; Regular Locking Fuel Cap .....	10521		2001-1999; OE Equivalent Fuel Cap .....	10834	
2008; OE Type Radiator Cap .....	10262	21	2001-1999; Regular Locking Fuel Cap .....	10504	
2008; OE Equivalent Fuel Cap .....	10834		2001-1999; Oil Filler Cap .....	10129	
2008; Regular Locking Fuel Cap .....	10504		<b>6-Cyl. 2.9 L</b>		
2008; Oil Filler Cap .....	10129		2005-1999; OE Type Radiator Cap .....	10244	22
2007; OE Type Radiator Cap .....	10244	22	2005-1999; OE Equivalent Fuel Cap .....	10834	
2007; OE Equivalent Fuel Cap .....	10851		2005-1999; Regular Locking Fuel Cap .....	10504	
2007; Regular Locking Fuel Cap .....	10521		2005-1999; Oil Filler Cap .....	10129	
2007; Oil Filler Cap .....	10129		<b>6-Cyl. 3.0 L</b>		
2006-2004; OE Type Radiator Cap .....	10262	21	2011; OE Type Radiator Cap .....	10262	21
2006-2004; OE Equivalent Fuel Cap .....	10851		2010-2008; OE Type Radiator Cap .....	10262	21
2006-2004; Regular Locking Fuel Cap .....	10521		2010-2008; OE Equivalent Fuel Cap .....	10834	
2006-2004; Oil Filler Cap .....	10129		2010-2008; Regular Locking Fuel Cap .....	10504	
<b>S60</b>			<b>6-Cyl. 3.2 L</b>		
<b>5-Cyl. 2.3 L</b>			2011; OE Type Radiator Cap .....	10262	21
2004-2001; OE Type Radiator Cap .....	10244	22	2010-2008; OE Type Radiator Cap .....	10262	21
2004-2001; OE Equivalent Fuel Cap .....	10834		2010-2008; OE Equivalent Fuel Cap .....	10834	
2004-2001; Regular Locking Fuel Cap .....	10504		2010-2008; Regular Locking Fuel Cap .....	10504	
2004-2001; Oil Filler Cap .....	10129		2007; OE Equivalent Fuel Cap .....	10834	
<b>5-Cyl. 2.4 L</b>			2007; Regular Locking Fuel Cap .....	10504	
2009; OE Type Radiator Cap .....	10244	22	<b>V-8 4.4 L</b>		
2009; OE Equivalent Fuel Cap .....	10834		2010-2008; OE Type Radiator Cap .....	10262	21
2009; Regular Locking Fuel Cap .....	10504		2010-2008; OE Equivalent Fuel Cap .....	10834	
2008-2001; OE Type Radiator Cap .....	10244	22	2010-2008; Regular Locking Fuel Cap .....	10504	
2008-2001; OE Equivalent Fuel Cap .....	10834		2007; OE Equivalent Fuel Cap .....	10834	
2008-2001; Regular Locking Fuel Cap .....	10504		2007; Regular Locking Fuel Cap .....	10504	
2008-2001; Oil Filler Cap .....	10129		<b>S90</b>		
<b>5-Cyl. 2.5 L</b>			<b>6-Cyl. 2.9 L</b>		
2009; OE Type Radiator Cap .....	10244	22	1998-1997; OE Type Radiator Cap .....	10244	22
2009; OE Equivalent Fuel Cap .....	10834		1998-1997; OE Equivalent Fuel Cap .....	10817	
2009; Regular Locking Fuel Cap .....	10504		1998-1997; Pre-Vent Non-Locking Fuel Cap .....	10819	
2008-2003; OE Type Radiator Cap .....	10244	22	1998-1997; Regular Locking Fuel Cap .....	10591	
2008-2003; OE Equivalent Fuel Cap .....	10834		1998-1997; Pre-Vent Locking Fuel Cap .....	10501	
2008-2003; Regular Locking Fuel Cap .....	10504		1998-1997; Oil Filler Cap .....	10129	
2008-2003; Oil Filler Cap .....	10129		<b>V40</b>		
<b>6-Cyl. 3.0 L</b>			<b>4-Cyl. 1.9 L</b>		
2011; OE Type Radiator Cap .....	10262	21	2004-2000; OE Type Radiator Cap .....	10244	22

## Caps for Passenger Cars and Light Trucks (1990 and Newer)

Application	Part Number	PSI	Application	Part Number	PSI
<b>Volvo - Continued</b>			<b>Volvo - Continued</b>		
<b>V40 - Continued</b>			<b>XC70 - Continued</b>		
<b>4-Cyl. 1.9 L - Continued</b>			<b>6-Cyl. 3.2 L</b>		
2004-2000; OE Equivalent Fuel Cap .....	10834		2011; OE Type Radiator Cap .....	10262	21
2004-2000; Regular Locking Fuel Cap .....	10504		2010-2008; OE Type Radiator Cap .....	10262	21
2004-2000; Oil Filler Cap .....	10129		2010-2008; OE Equivalent Fuel Cap .....	10834	
<b>V50</b>			2010-2008; Regular Locking Fuel Cap .....		
<b>5-Cyl. 2.4 L</b>			10504		
2010-2005; OE Type Radiator Cap .....	10262	21	<b>XC90</b>		
2010-2005; OE Equivalent Fuel Cap .....	10851		<b>5-Cyl. 2.5 L</b>		
2010-2005; Regular Locking Fuel Cap .....	10521		2006-2003; OE Type Radiator Cap .....		
<b>5-Cyl. 2.5 L</b>			10244		
2011-2005; OE Type Radiator Cap .....	10262	21	2006-2003; OE Equivalent Fuel Cap .....		
2011-2005; OE Equivalent Fuel Cap .....	10851		10834		
2011-2005; Regular Locking Fuel Cap .....	10521		2006-2003; Regular Locking Fuel Cap .....		
<b>V70</b>			10504		
<b>5-Cyl. 2.3 L</b>			2006-2003; Oil Filler Cap .....		
2004-2000; OE Type Radiator Cap .....	10244	22	10129		
2004-2000; OE Equivalent Fuel Cap .....	10834		<b>6-Cyl. 2.9 L</b>		
2004-2000; Regular Locking Fuel Cap .....	10504		2005-2003; OE Type Radiator Cap .....		
2004-2000; Oil Filler Cap .....	10129		10244		
1999-1998; OE Type Radiator Cap .....	10244	22	2005-2003; OE Equivalent Fuel Cap .....		
1999-1998; Oil Filler Cap .....	10129		10834		
<b>5-Cyl. 2.4 L</b>			2005-2003; Regular Locking Fuel Cap .....		
2007-1999; OE Type Radiator Cap .....	10244	22	10504		
2007-1999; OE Equivalent Fuel Cap .....	10834		2005-2003; Oil Filler Cap .....		
2007-1999; Regular Locking Fuel Cap .....	10504		10129		
2007-1999; Oil Filler Cap .....	10129		<b>6-Cyl. 3.2 L</b>		
1998; OE Type Radiator Cap .....	10244	22	2011; OE Type Radiator Cap .....		
1998; OE Equivalent Fuel Cap .....	10817		10244		
1998; Pre-Vent Non-Locking Fuel Cap .....	10819		2010-2007; OE Type Radiator Cap .....		
1998; Regular Locking Fuel Cap .....	10591		10244		
1998; Pre-Vent Locking Fuel Cap .....	10501		2010-2007; OE Equivalent Fuel Cap .....		
1998; Oil Filler Cap .....	10129		10834		
<b>5-Cyl. 2.5 L</b>			2010-2007; Regular Locking Fuel Cap .....		
2007-2003; OE Type Radiator Cap .....	10244	22	10504		
2007-2003; OE Equivalent Fuel Cap .....	10834		2006; OE Equivalent Fuel Cap .....		
2007-2003; Regular Locking Fuel Cap .....	10504		10834		
2007-2003; Oil Filler Cap .....	10129		2006; Regular Locking Fuel Cap .....		
<b>6-Cyl. 3.2 L</b>			10504		
2010-2008; OE Type Radiator Cap .....	10262	21	2005; OE Type Radiator Cap .....		
2010-2008; OE Equivalent Fuel Cap .....	10834		10244		
2010-2008; Regular Locking Fuel Cap .....	10504		22		
<b>V90</b>					
<b>6-Cyl. 2.9 L</b>					
1998-1997; OE Type Radiator Cap .....	10244	22			
1998-1997; OE Equivalent Fuel Cap .....	10817				
1998-1997; Pre-Vent Non-Locking Fuel Cap .....	10819				
1998-1997; Regular Locking Fuel Cap .....	10591				
1998-1997; Pre-Vent Locking Fuel Cap .....	10501				
1998-1997; Oil Filler Cap .....	10129				
<b>XC60</b>					
<b>6-Cyl. 3.0 L; 6-Cyl. 3.2 L</b>					
2011; OE Type Radiator Cap .....	10262	21			
2010; OE Type Radiator Cap .....	10262	21			
2010; OE Equivalent Fuel Cap .....	10834				
2010; Regular Locking Fuel Cap .....	10504				
<b>XC70</b>					
<b>5-Cyl. 2.5 L</b>					
2007-2003; OE Type Radiator Cap .....	10244	22			
2007-2003; OE Equivalent Fuel Cap .....	10834				
2007-2003; Regular Locking Fuel Cap .....	10504				
2007-2003; Oil Filler Cap .....	10129				
<b>6-Cyl. 3.0 L</b>					
2011; OE Type Radiator Cap .....	10262	21			
2010-2009; OE Type Radiator Cap .....	10262	21			
2010-2009; OE Equivalent Fuel Cap .....	10834				
2010-2009; Regular Locking Fuel Cap .....	10504				

# Thermostats for Passenger Cars and Light Trucks (1990 and Newer)

Application	Part Number	Temp°F	Application	Part Number	Temp°F
<b>Acura</b>			<b>Acura - Continued</b>		
<b>CL</b>			<b>NSX</b>		
4-Cyl. 2.2 L			V-6 3.0 L		
1997; OE Exact Thermostat .....	◆48158	180	2005-1995; OE Exact Thermostat .....	◆48227	170
1997; Premium Thermostat .....	◆45878	180	2005-1995; OE Type Thermostat .....	◆14127	170
	◇45879	195		◇14128	180
	◇45877	170	V-6 3.2 L		
1997; OE Type Thermostat .....	◆13878	180	2005-1997; OE Exact Thermostat .....	◆48227	170
	◇13879	195	2005-1997; OE Type Thermostat .....	◆14127	170
				◇14128	180
4-Cyl. 2.3 L			<b>RDX</b>		
1999-1998; OE Exact Thermostat .....	◆48158	180	4-Cyl. 2.3 L		
1999-1998; Premium Thermostat .....	◆45878	180	2008-2007; OE Exact Thermostat Water Outlet		
	◇45879	195	Assembly .....	◆○48747	172
	◇45877	170	<b>RL</b>		
1999-1998; OE Type Thermostat .....	◆13878	180	V-6 3.5 L		
	◇13879	195	2008-1996; OE Exact Thermostat .....	◆48227	170
V-6 3.0 L			2008-1996; OE Type Thermostat .....	◆○14337	170
1999-1997; OE Exact Thermostat .....	◆48227	170	V-6 3.7 L		
1999-1997; OE Type Thermostat .....	◆14127	170	2010-2009; OE Exact Thermostat .....	◆48227	170
	◇14128	180	2010-2009; OE Type Thermostat .....	◆○14337	170
V-6 3.2 L			<b>RSX</b>		
2003-2001; OE Exact Thermostat .....	◆48227	170	4-Cyl. 2.0 L		
2003-2001; OE Type Thermostat .....	◆○14337	170	2006-2002; Thermostat Water Outlet Assembly .....	◆○14757	172
<b>EL</b>			<b>SLX</b>		
4-Cyl. 1.6 L (Canada)			V-6 3.2 L		
2000; OE Exact Thermostat .....	◆48158	180	1997-1996; OE Type Thermostat .....	◆14177	170
2000; Premium Thermostat .....	◆45878	180		◇14178	180
	◇45879	195	V-6 3.5 L		
	◇45877	170	1999; OE Type Thermostat .....	◆○14327	170
2000; OE Type Thermostat .....	◆13878	180	1998; OE Type Thermostat .....	◆14177	170
	◇13879	195		◇14178	180
4-Cyl. 1.7 L (Canada)			<b>TL</b>		
2005-2002; Premium Thermostat .....	◆45877	170	5-Cyl. 2.5 L		
	◇45879	195	1998-1997; OE Type Thermostat .....	◆14128	180
	◇45878	180		◇14127	170
2001; Premium Thermostat .....	◆45878	180	1996; OE Exact Thermostat .....	◆48227	170
	◇45879	195	1996; OE Type Thermostat .....	◆14127	170
	◇45877	170		◇14128	180
2001; OE Type Thermostat .....	◆13878	180	1995; OE Type Thermostat .....	◆14128	180
	◇13879	195		◇14127	170
<b>Integra</b>			V-6 3.2 L		
4-Cyl. 1.8 L			2008-2001; OE Exact Thermostat .....	◆48227	170
2001-1995; OE Exact Thermostat .....	◆48158	180	2008-2001; OE Type Thermostat .....	◆○14337	170
2001-1995; Premium Thermostat .....	◆45878	180	2000-1999; OE Type Thermostat .....	◆○14337	170
	◇45879	195	1998-1996; OE Exact Thermostat .....	◆48227	170
	◇45877	170	1998-1996; OE Type Thermostat .....	◆14127	170
2001-1995; OE Type Thermostat .....	◆13878	180		◇14128	180
	◇13879	195	V-6 3.5 L		
<b>Legend</b>			2011-2007; OE Exact Thermostat .....	◆48227	170
V-6 3.2 L			2011-2007; OE Type Thermostat .....	◆○14337	170
1995; OE Exact Thermostat .....	◆48227	170	V-6 3.7 L		
1995; OE Type Thermostat .....	◆14127	170	2011-2009; OE Exact Thermostat .....	◆48227	170
	◇14128	180	2011-2009; OE Type Thermostat .....	◆○14337	170
<b>MDX</b>			<b>TSX</b>		
V-6 3.5 L			4-Cyl. 2.4 L		
2006-2001; OE Exact Thermostat .....	◆48227	170	2011-2009; OE Exact Thermostat Water Outlet		
2006-2001; OE Type Thermostat .....	◆○14337	170	Assembly .....	◆○48767	172
V-6 3.7 L			2008-2004; OE Exact Thermostat Water Outlet		
2011; OE Type Thermostat .....	◆○14337	170	Assembly .....	◆○48747	172
2011; OE Exact Thermostat .....	◆48227	170	V-6 3.5 L		
2010-2007; OE Exact Thermostat .....	◆48227	170	2011-2010; OE Exact Thermostat .....	◆48227	170
2010-2007; OE Type Thermostat .....	◆○14337	170			

◆ OE Temperature.  
○ Seal Included.

◇ Alternate Temperature.

# Thermostats for Passenger Cars and Light Trucks (1990 and Newer)

Application	Part Number	Temp°F	Application	Part Number	Temp°F
<b>Acura - Continued</b>			<b>Audi - Continued</b>		
<b>TSX - Continued</b>			<b>Allroad Quattro - Continued</b>		
V-6 3.5 L - Continued			V-8 4.2 L		
2011-2010; OE Type Thermostat .....	◆○14337	170	2004-2003; OE Exact Thermostat .....	◆○48049	189
<b>ZDX</b>			2004-2003; OE Type Thermostat .....	◆14099	190
V-6 3.7 L			<b>Cabriolet</b>		
2010; OE Exact Thermostat .....	◆48227	170	V-6 2.8 L		
2010; OE Type Thermostat .....	◆○14337	170	1998-1995; OE Exact Thermostat .....		
<b>AM General</b>			1998-1995; OE Type Thermostat .....		
<b>Hummer</b>			◆○48049 189		
V-8 5.7 L			◆14099 190		
1996-1995; OE Type Thermostat .....	◆○14399	190	<b>S4</b>		
V-8 6.5 L Diesel			V-6 2.7 L		
2001-2000; OE Type Thermostat .....	◆○14399	190	2002-2000; OE Exact Thermostat .....		
1999; OE Type Thermostat .....	②◆○14399	190	2002-2000; OE Type Thermostat .....		
1998-1996; OE Type Thermostat; W/O Turbo .....	◆14429	190	V-8 4.2 L		
1998-1996; OE Type Thermostat; W/Turbo .....	◆○14399	190	2006-2004; OE Exact Thermostat .....		
1995; OE Type Thermostat .....	◆14429	190	2006-2004; OE Type Thermostat .....		
<b>Audi</b>			<b>S6</b>		
<b>90</b>			5-Cyl. 2.2 L		
V-6 2.8 L			1995; OE Type Thermostat .....		
1995; OE Type Thermostat .....	◆14099	190	◆13588 176		
<b>A4</b>			5-Cyl. 2.2 L (Canada)		
4-Cyl. 1.8 L			1996; OE Type Thermostat .....		
2006-2002; OE Exact Thermostat Water Outlet			◆13588 176		
Assembly .....	◆○48732	202	<b>S8</b>		
2001-1997; OE Type Thermostat .....	◆14419	190	V-8 4.2 L		
4-Cyl. 2.0 L			2003; OE Exact Thermostat .....		
2010-2005; OE Exact Thermostat Water Outlet			◆○48049 189		
Assembly .....	◆○49099	180	2003; OE Type Thermostat .....		
V-6 2.8 L			2002; OE Exact Thermostat .....		
2001; OE Type Thermostat .....	◆13649	190	◆○48049 189		
	◆13648	180	◆○48049 189		
2000-1997; OE Exact Thermostat .....	◆○48049	189	2001; OE Exact Thermostat .....		
2000-1997; OE Type Thermostat .....	◆14099	190	◆○48049 189		
1996; OE Type Thermostat .....	◆14099	190	2001; OE Type Thermostat .....		
V-6 3.2 L			◆14099 190		
2007-2006; OE Exact Thermostat Water Outlet			<b>TT</b>		
Assembly .....	◆○49099	180	4-Cyl. 1.8 L		
<b>A6</b>			2003-2000; OE Type Thermostat .....		
V-6 2.7 L			◆14419 190		
2004-2000; OE Exact Thermostat .....	◆○48049	189	<b>BMW</b>		
2004-2000; OE Type Thermostat .....	◆14099	190	<b>318i</b>		
V-6 2.8 L			4-Cyl. 1.8 L		
2001-1995; OE Exact Thermostat .....	◆○48049	189	1995; OE Exact Thermostat .....		
2001-1995; OE Type Thermostat .....	◆14099	190	◆○48648 176		
V-8 4.2 L			1995; OE Type Thermostat .....		
2004-2000; OE Type Thermostat .....	◆14099	190	◆13588 176		
2004-2000; OE Exact Thermostat .....	◆○48049	189	4-Cyl. 1.9 L		
<b>A8</b>			1998-1996; Thermostat Water Outlet Assembly .....		
V-8 3.7 L			◆○14632 203		
1999-1997; OE Exact Thermostat .....	◆○48049	189	4-Cyl. 1.9 L (Canada)		
1999-1997; OE Type Thermostat .....	◆14099	190	1999; Thermostat Water Outlet Assembly .....		
V-8 4.2 L			◆○14632 203		
2008-2002; OE Type Thermostat .....	◆13588	176	<b>318IS</b>		
2001-2000; OE Type Thermostat .....	◆14099	190	4-Cyl. 1.8 L		
1999-1997; OE Exact Thermostat .....	◆○48049	189	1995; OE Exact Thermostat .....		
1999-1997; OE Type Thermostat .....	◆14099	190	◆○48648 176		
<b>Allroad Quattro</b>			1995; OE Type Thermostat .....		
V-6 2.7 L			◆13588 176		
2005; OE Type Thermostat .....	◆13588	176	4-Cyl. 1.9 L		
2004-2002; OE Exact Thermostat .....	◆○48049	189	1997-1996; Thermostat Water Outlet Assembly .....		
2004-2002; OE Type Thermostat .....	◆14099	190	◆○14632 203		
2001; OE Type Thermostat .....	◆13649	190	4-Cyl. 1.9 L (Canada)		
	◆13648	180	1999-1998; Thermostat Water Outlet Assembly .....		
			◆○14632 203		
			<b>323Ci</b>		
			6-Cyl. 2.5 L		
			2000; Thermostat Water Outlet Assembly .....		
			◆○14602 206		
			<b>323i</b>		
			6-Cyl. 2.5 L		
			2000; Thermostat Water Outlet Assembly .....		
			◆○14602 206		
			1999-1998; OE Type Thermostat .....		
			◆○14622 198		

◆ OE Temperature.  
 ② Two Required.

○ Seal Included.  
 ◆ Alternate Temperature.

## Thermostats for Passenger Cars and Light Trucks (1990 and Newer)

Application	Part Number	Temp°F	Application	Part Number	Temp°F
<b>BMW - Continued</b>			<b>BMW - Continued</b>		
<b>323IS</b>			<b>740IL</b>		
6-Cyl. 2.5 L 1999-1998; OE Type Thermostat .....	◆○14622	198	V-8 4.0 L 1995; OE Type Thermostat .....	◆14188	180
<b>325CI</b>			<b>V-8 4.4 L</b>		
6-Cyl. 2.5 L 2006-2001; Thermostat Water Outlet Assembly .....	◆○14602	206	2001-1999; Thermostat Water Outlet Assembly .....	◆○14612	221
<b>325I</b>			1998; Thermostat Water Outlet Assembly; Nov. 1, 1998 & Newer .....		
6-Cyl. 2.5 L 2005-2001; Thermostat Water Outlet Assembly .....	◆○14602	206	1997-1996; Thermostat Water Outlet Assembly .....	◆○14612	221
1995; OE Exact Thermostat .....	◆○48648	176	<b>750IL</b>		
1995; OE Type Thermostat .....	◆13588	176	V-12 5.4 L		
<b>325IS</b>			1995; OE Type Thermostat .....		
6-Cyl. 2.5 L 1995; OE Exact Thermostat .....	◆○48648	176	◆14188 180		
1995; OE Type Thermostat .....	◆13588	176	<b>840CI</b>		
<b>325XI</b>			V-8 4.0 L		
6-Cyl. 2.5 L 2005-2001; Thermostat Water Outlet Assembly .....	◆○14602	206	1995; OE Type Thermostat .....		
<b>328CI</b>			◆14188 180		
6-Cyl. 2.8 L 2000; Thermostat Water Outlet Assembly .....	◆○14602	206	V-8 4.4 L		
<b>328I</b>			1997-1996; Thermostat Water Outlet Assembly .....		
6-Cyl. 2.8 L 2000-1999; Thermostat Water Outlet Assembly .....	◆○14602	206	◆○14612 221		
1998-1996; OE Type Thermostat .....	◆○14622	198	<b>850CI</b>		
<b>328IS</b>			V-12 5.4 L		
6-Cyl. 2.8 L 1999-1996; OE Type Thermostat .....	◆○14622	198	1997-1995; OE Type Thermostat .....		
<b>330CI</b>			◆14188 180		
6-Cyl. 3.0 L 2006-2001; Thermostat Water Outlet Assembly .....	◆○14602	206	<b>850CSI</b>		
<b>330I; 330XI</b>			V-12 5.6 L		
6-Cyl. 3.0 L 2005-2001; Thermostat Water Outlet Assembly .....	◆○14602	206	1995; OE Type Thermostat .....		
<b>525I</b>			◆14188 180		
6-Cyl. 2.5 L 2005-2001; Thermostat Water Outlet Assembly .....	◆○14602	206	<b>M3</b>		
1995; OE Exact Thermostat .....	◆○48648	176	6-Cyl. 3.0 L		
1995; OE Type Thermostat .....	◆13588	176	1995; OE Exact Thermostat .....		
<b>528I</b>			◆○48648 176		
6-Cyl. 2.8 L 2000-1999; Thermostat Water Outlet Assembly .....	◆○14602	206	1995; OE Type Thermostat .....		
1998-1997; OE Type Thermostat .....	◆○14622	198	◆13588 176		
<b>530I</b>			6-Cyl. 3.2 L		
6-Cyl. 3.0 L 2005-2001; Thermostat Water Outlet Assembly .....	◆○14602	206	2001; OE Type Thermostat .....		
<b>540I</b>			1999-1996; OE Exact Thermostat .....		
V-8 3.0 L 1995; OE Type Thermostat .....	◆14188	180	◆○48648 176		
<b>740I</b>			1999-1996; OE Type Thermostat .....		
V-8 4.0 L 1995; OE Type Thermostat .....	◆14188	180	◆13588 176		
V-8 4.4 L 2003-1999; Thermostat Water Outlet Assembly .....	◆○14612	221	<b>M5; M6</b>		
<b>740I</b>			V-10 5.0 L		
V-8 4.0 L 1995; OE Type Thermostat .....	◆14188	180	2008-2006; Heavy-Duty Thermostat .....		
V-8 4.4 L 2001-1999; Thermostat Water Outlet Assembly .....	◆○14612	221	◆○14537 170		
1998; Thermostat Water Outlet Assembly; Nov. 1, 1998 & Newer .....	◆○14612	221	◆○14539 190		
<b>740I</b>			◆○14538 180		
V-8 4.0 L 1995; OE Type Thermostat .....	◆14188	180	◆○14536 160		
V-8 4.4 L 2001-1999; Thermostat Water Outlet Assembly .....	◆○14612	221	<b>X3</b>		
1998; Thermostat Water Outlet Assembly; Nov. 1, 1998 & Newer .....	◆○14612	221	6-Cyl. 2.5 L		
<b>740I</b>			2005-2004; Thermostat Water Outlet Assembly .....		
V-8 4.0 L 1995; OE Type Thermostat .....	◆14188	180	◆○14602 206		
V-8 4.4 L 2001-1999; Thermostat Water Outlet Assembly .....	◆○14612	221	6-Cyl. 2.5 L (Canada)		
1998; Thermostat Water Outlet Assembly; Nov. 1, 1998 & Newer .....	◆○14612	221	2006; Thermostat Water Outlet Assembly .....		
<b>740I</b>			◆○14602 206		
V-8 4.0 L 1995; OE Type Thermostat .....	◆14188	180	6-Cyl. 3.0 L		
V-8 4.4 L 2001-1999; Thermostat Water Outlet Assembly .....	◆○14612	221	2006-2004; Thermostat Water Outlet Assembly .....		
1998; Thermostat Water Outlet Assembly; Nov. 1, 1998 & Newer .....	◆○14612	221	◆○14602 206		
<b>740I</b>			<b>X5</b>		
V-8 4.0 L 1995; OE Type Thermostat .....	◆14188	180	6-Cyl. 3.0 L		
V-8 4.4 L 2001-1999; Thermostat Water Outlet Assembly .....	◆○14612	221	2006-2001; Thermostat Water Outlet Assembly .....		
1998; Thermostat Water Outlet Assembly; Nov. 1, 1998 & Newer .....	◆○14612	221	◆○14602 206		
<b>740I</b>			V-8 4.4 L		
V-8 4.0 L 1995; OE Type Thermostat .....	◆14188	180	2006; Thermostat Water Outlet Assembly .....		
V-8 4.4 L 2001-1999; Thermostat Water Outlet Assembly .....	◆○14612	221	◆○14612 221		
1998; Thermostat Water Outlet Assembly; Nov. 1, 1998 & Newer .....	◆○14612	221	2003-2000; Thermostat Water Outlet Assembly .....		
<b>740I</b>			◆○14612 221		
V-8 4.0 L 1995; OE Type Thermostat .....	◆14188	180	V-8 4.6 L		
V-8 4.4 L 2001-1999; Thermostat Water Outlet Assembly .....	◆○14612	221	2003-2002; Thermostat Water Outlet Assembly .....		
1998; Thermostat Water Outlet Assembly; Nov. 1, 1998 & Newer .....	◆○14612	221	◆○14612 221		
<b>740I</b>			V-8 4.8 L		
V-8 4.0 L 1995; OE Type Thermostat .....	◆14188	180	2004; Thermostat Water Outlet Assembly .....		
V-8 4.4 L 2001-1999; Thermostat Water Outlet Assembly .....	◆○14612	221	◆○14612 221		
1998; Thermostat Water Outlet Assembly; Nov. 1, 1998 & Newer .....	◆○14612	221	<b>Z3</b>		
<b>740I</b>			4-Cyl. 1.9 L		
V-8 4.0 L 1995; OE Type Thermostat .....	◆14188	180	1998-1996; Thermostat Water Outlet Assembly .....		
V-8 4.4 L 2001-1999; Thermostat Water Outlet Assembly .....	◆○14612	221	◆○14632 203		
1998; Thermostat Water Outlet Assembly; Nov. 1, 1998 & Newer .....	◆○14612	221	6-Cyl. 2.5 L		
<b>740I</b>			2002-1999; Thermostat Water Outlet Assembly .....		
V-8 4.0 L 1995; OE Type Thermostat .....	◆14188	180	◆○14602 206		
V-8 4.4 L 2001-1999; Thermostat Water Outlet Assembly .....	◆○14612	221	6-Cyl. 2.8 L		
1998; Thermostat Water Outlet Assembly; Nov. 1, 1998 & Newer .....	◆○14612	221	2000-1999; Thermostat Water Outlet Assembly .....		
<b>740I</b>			1998-1997; OE Type Thermostat .....		
V-8 4.0 L 1995; OE Type Thermostat .....	◆14188	180	◆○14602 206		
V-8 4.4 L 2001-1999; Thermostat Water Outlet Assembly .....	◆○14612	221	◆○14622 198		
1998; Thermostat Water Outlet Assembly; Nov. 1, 1998 & Newer .....	◆○14612	221	6-Cyl. 3.0 L		
<b>740I</b>			2002-2001; Thermostat Water Outlet Assembly .....		
V-8 4.0 L 1995; OE Type Thermostat .....	◆14188	180	◆○14602 206		

◆ OE Temperature.  
◇ Alternate Temperature.

○ Seal Included.

## Thermostats for Passenger Cars and Light Trucks (1990 and Newer)

Application	Part Number	Temp°F	Application	Part Number	Temp°F
<b>BMW - Continued</b>			<b>Buick - Continued</b>		
<b>Z3 - Continued</b>			<b>Rainier</b>		
6-Cyl. 3.2 L			6-Cyl. 4.2 L		
2000; OE Exact Thermostat .....	◆○48648	176	2007-2004; Thermostat Water Outlet Assembly .....	◆○14659	190
2000; OE Type Thermostat .....	◆13588	176	V-8 5.3 L		
1999-1998; OE Type Thermostat .....	◆13588	176	2006-2004; Heavy-Duty Thermostat .....	◆○14948	186
<b>Z4</b>			<b>Regal</b>		
6-Cyl. 2.5 L; 6-Cyl. 3.0 L			4-Cyl. 2.0 L; 4-Cyl. 2.4 L		
2005-2003; Thermostat Water Outlet Assembly .....	◆○14602	206	2012-2011; OE Exact Thermostat .....	◆○48628	180
<b>Z8</b>			2012-2011; OE Type Thermostat .....	◆○14698	180
V-8 4.8 L			V-6 3.1 L		
2003; Thermostat Water Outlet Assembly .....	◆○14612	221	1996-1995; Premium Thermostat .....	◆○45899	195
<b>Buick</b>			1996-1995; OE Type Thermostat .....	◆○13899	195
<b>Allure</b>			V-6 3.8 L		
V-6 3.8 L (Canada)			2004-1995; Premium Thermostat .....	◆45849	195
2007-2005; Premium Thermostat .....	◆45849	195		◆45848	180
	◆45848	180	2004-1995; OE Type Thermostat .....	◆13849	195
2007-2005; OE Type Thermostat .....	◆13849	195		◆13848	180
	◆13848	180	<b>Rendezvous</b>		
2007-2005; Premium Thermostat .....	◆45849	195	V-6 3.4 L		
	◆45848	180	2005-2002; Premium Thermostat .....	◆○45899	195
2007-2005; OE Type Thermostat .....	◆13849	195	2005-2002; OE Type Thermostat .....	◆○13899	195
	◆13848	180	V-6 3.5 L		
2007-2005; Premium Thermostat .....	◆45849	195	2007-2006; Premium Thermostat .....	◆○45899	195
	◆45848	180	2007-2006; OE Type Thermostat .....	◆○13899	195
2007-2005; OE Type Thermostat .....	◆13849	195	<b>Riviera</b>		
	◆13848	180	V-6 3.8 L		
<b>Century</b>			1999-1995; Premium Thermostat .....	◆45849	195
4-Cyl. 2.2 L				◆45848	180
1996-1995; Premium Thermostat .....	◆45849	195	1999-1995; OE Type Thermostat .....	◆13849	195
	◆45848	180		◆13848	180
1996-1995; OE Type Thermostat .....	◆13849	195	<b>Roadmaster</b>		
	◆13848	180	V-8 5.7 L		
V-6 3.1 L			1996-1995; Premium Thermostat .....	◆○45218	180
2005-1995; Premium Thermostat .....	◆○45899	195	1996-1995; OE Type Thermostat .....	◆○14218	180
2005-1995; OE Type Thermostat .....	◆○13899	195	<b>Skylark</b>		
<b>LaCrosse</b>			4-Cyl. 2.3 L		
4-Cyl. 2.4 L			1995; Premium Thermostat .....	◆45028	180
2011-2010; OE Exact Thermostat .....	◆○48628	180	1995; OE Type Thermostat .....	◆14028	180
2011-2010; OE Type Thermostat .....	◆○14698	180	4-Cyl. 2.4 L		
V-6 3.8 L			1998-1996; Premium Thermostat .....	◆45028	180
2009-2005; Premium Thermostat .....	◆45849	195	1998-1996; OE Type Thermostat .....	◆14028	180
	◆45848	180	V-6 3.1 L		
2009-2005; OE Type Thermostat .....	◆13849	195	1998-1995; Premium Thermostat .....	◆○45899	195
	◆13848	180	1998-1995; OE Type Thermostat .....	◆○13899	195
V-8 5.3 L			<b>Terraza</b>		
2009; Heavy-Duty Thermostat .....	◆○14948	186	V-6 3.5 L		
<b>Lesabre</b>			2006-2005; Premium Thermostat .....	◆○45899	195
V-6 3.8 L			2006-2005; OE Type Thermostat .....	◆○13899	195
2005-1995; Premium Thermostat .....	◆45849	195	V-6 3.9 L		
	◆45848	180	2007-2006; OE Exact Thermostat .....	◆○48808	185
2005-1995; OE Type Thermostat .....	◆13849	195	<b>Cadillac</b>		
	◆13848	180	<b>Catera</b>		
<b>Lucerne</b>			V-6 3.0 L		
V-6 3.8 L			2001-1999; OE Exact Thermostat Valve Motor & Spring Assembly; W/O Early GM Housing .....	◆48759	198
2008-2006; Premium Thermostat .....	◆45849	195	2001-1999; Thermostat Water Outlet Assembly; W/Early GM Housing .....	◆○14309	195
	◆45848	180	<b>CTS</b>		
2008-2006; OE Type Thermostat .....	◆13849	195	V-6 2.8 L		
	◆13848	180	2007-2005; OE Exact Thermostat Water Outlet Assembly .....	◆○48818	180
V-6 3.9 L			V-6 3.0 L		
2011-2009; OE Exact Thermostat .....	◆○48808	185	2010; OE Exact Thermostat Water Outlet Assembly .....	◆○48818	180
V-8 4.6 L			<b>Park Avenue</b>		
2011-2006; OE Type Thermostat .....	◆○14228	180	V-6 3.8 L		
<b>Park Avenue</b>			2005-1995; Premium Thermostat .....	◆45849	195
V-6 3.8 L				◆45848	180
2005-1995; Premium Thermostat .....	◆45849	195	2005-1995; OE Type Thermostat .....	◆13849	195
	◆45848	180		◆13848	180
2005-1995; OE Type Thermostat .....	◆13849	195	<b>CTS</b>		
	◆13848	180	V-6 2.8 L		
<b>Park Avenue</b>			2007-2005; OE Exact Thermostat Water Outlet Assembly .....	◆○48818	180
V-6 3.8 L			V-6 3.0 L		
2005-1995; Premium Thermostat .....	◆45849	195	2010; OE Exact Thermostat Water Outlet Assembly .....	◆○48818	180
	◆45848	180	<b>CTS</b>		
2005-1995; OE Type Thermostat .....	◆13849	195	V-6 2.8 L		
	◆13848	180	2007-2005; OE Exact Thermostat Water Outlet Assembly .....	◆○48818	180

◆ OE Temperature.  
 ◆ Alternate Temperature.

○ Seal Included.

## Thermostats for Passenger Cars and Light Trucks (1990 and Newer)

Application	Part Number	Temp°F	Application	Part Number	Temp°F
<b>Cadillac - Continued</b>			<b>Cadillac - Continued</b>		
<b>CTS - Continued</b>			<b>STS - Continued</b>		
V-6 3.2 L 2004-2003; OE Exact Thermostat Valve Motor & Spring Assembly; W/O Early GM Housing .....	◆48759	198	V-8 4.4 L 2009-2006; OE Type Thermostat .....	◆○14228	180
2004-2003; Thermostat Water Outlet Assembly; W/Early GM Housing .....	◆○14309	195	V-8 4.6 L 2010-2005; OE Type Thermostat .....	◆○14228	180
V-6 3.6 L 2010-2004; OE Exact Thermostat Water Outlet Assembly .....	◆○48818	180	<b>XLR</b>		
V-8 5.7 L 2005-2004; Heavy-Duty Thermostat .....	◆○14948	186	V-8 4.4 L 2007-2006; OE Type Thermostat .....	◆○14228	180
V-8 6.0 L 2007-2006; Heavy-Duty Thermostat .....	◆○14948	186	V-8 4.6 L 2009-2004; OE Type Thermostat .....	◆○14228	180
<b>Deville</b>			<b>Chevrolet</b>		
V-8 4.6 L 2005-1995; OE Type Thermostat .....	◆○14228	180	<b>Astro</b>		
V-8 4.9 L 1995; Premium Thermostat .....	◆45359	195	V-6 4.3 L 2005-1996; Premium Thermostat .....	◆○45119	195
	◆45358	180	2005-1996; OE Type Thermostat .....	◆○14119	195
	◆45356	160	1995; Premium Thermostat .....	◆45849	195
1995; OE Type Thermostat .....	◆13359	195		◆45848	180
	◆13352	205	1995; OE Type Thermostat .....	◆13849	195
	◆13358	180		◆13848	180
	◆13356	160	<b>Avalanche</b>		
1995; Economy Thermostat .....	◆13009	195	V-8 5.3 L 2006; Heavy-Duty Thermostat .....	◆○14948	186
	◆13008	180	2005-2004; Thermostat Water Outlet Assembly; W/Most Aftermarket Water Pumps .....	◆○14298	186
	◆13006	160	2005-2004; Heavy-Duty Thermostat; W/OE or GM Replacement Water Pump .....	◆○14948	186
<b>DTS</b>			2003-2002; Thermostat Water Outlet Assembly; W/OE or Most Aftermarket Water Pumps .....	◆○14298	186
V-8 4.6 L 2011-2006; OE Type Thermostat .....	◆○14228	180	2003-2002; Heavy-Duty Thermostat; W/GM Replacement Water Pump .....	◆○14948	186
<b>Eldorado</b>			V-8 8.1 L 2006-2002; Premium Thermostat .....	◆○45899	195
V-8 4.6 L 2002-1995; OE Type Thermostat .....	◆○14228	180	2006-2002; OE Type Thermostat .....	◆○13899	195
<b>Escalade</b>			<b>Aveo</b>		
V-8 5.3 L 2005-2004; Heavy-Duty Thermostat .....	◆○14948	186	4-Cyl. 1.6 L 2008-2004; OE Type Thermostat; For Metal Housing Only .....	◆13349	195
2003-2002; Thermostat Water Outlet Assembly; W/OE or Most Aftermarket Water Pumps .....	◆○14298	186	<b>Beretta</b>		
2003-2002; Heavy-Duty Thermostat; W/GM Replacement Water Pump .....	◆○14948	186	4-Cyl. 2.2 L 1996; Premium Thermostat .....	◆45028	180
V-8 5.7 L 2000-1999; Premium Thermostat .....	◆○45119	195	1996; OE Type Thermostat .....	◆14028	180
2000-1999; OE Type Thermostat .....	◆○14119	195	1995; Premium Thermostat .....	◆45849	195
V-8 6.0 L 2006-2004; Heavy-Duty Thermostat .....	◆○14948	186		◆45848	180
2003-2002; Thermostat Water Outlet Assembly; W/OE or Most Aftermarket Water Pumps .....	◆○14298	186	1995; OE Type Thermostat .....	◆13849	195
2003-2002; Heavy-Duty Thermostat; W/GM Replacement Water Pump .....	◆○14948	186		◆13848	180
<b>Fleetwood</b>			V-6 3.1 L 1996-1995; Premium Thermostat .....	◆○45899	195
V-8 5.7 L 1996-1995; Premium Thermostat .....	◆○45218	180	1996-1995; OE Type Thermostat .....	◆○13899	195
1996-1995; OE Type Thermostat .....	◆○14218	180	<b>Blazer</b>		
<b>Seville</b>			V-6 4.3 L 2005-1996; Premium Thermostat .....	◆○45119	195
V-8 4.6 L 2004-1995; OE Type Thermostat .....	◆○14228	180	2005-1996; OE Type Thermostat .....	◆○14119	195
<b>SRX</b>			1995; Premium Thermostat .....	◆45849	195
V-6 3.6 L 2009-2004; OE Exact Thermostat Water Outlet Assembly .....	◆○48818	180		◆45848	180
V-8 4.6 L 2009-2004; OE Type Thermostat .....	◆○14228	180	1995; OE Type Thermostat .....	◆13849	195
<b>STS</b>				◆13848	180
V-6 3.6 L 2007; OE Exact Thermostat Water Outlet Assembly .....	◆○48818	180	<b>C &amp; K Series Pickup</b>		
			V-6 4.3 L 1998-1996; Premium Thermostat .....	◆○45119	195
			1998-1996; OE Type Thermostat .....	◆○14119	195
			1995; Premium Thermostat .....	◆45359	195
				◆45358	180
				◆45356	160

◆ OE Temperature.  
 ◆ Alternate Temperature.

○ Seal Included.

# Thermostats for Passenger Cars and Light Trucks (1990 and Newer)

Application	Part Number	Temp°F	Application	Part Number	Temp°F
<b>Chevrolet - Continued</b>			<b>Chevrolet - Continued</b>		
<b>C &amp; K Series Pickup - Continued</b>			<b>Caprice</b>		
<b>V-6 4.3 L - Continued</b>			<b>V-8 4.3 L; V-8 5.7 L</b>		
1995; OE Type Thermostat .....	◆13359	195	1996-1995; Premium Thermostat .....	◆○45218	180
	◆13352	205	1996-1995; OE Type Thermostat .....	◆○14218	180
	◆13358	180	<b>Cavalier</b>		
	◆13356	160	<b>4-Cyl. 2.2 L</b>		
1995; Economy Thermostat .....	◆13009	195	2005-2003; OE Exact Thermostat .....	◆○48628	180
	◆13008	180	2005-2003; OE Type Thermostat .....	◆○14698	180
	◆13006	160	2002; Premium Thermostat; Eng. VIN 4 .....	◆45028	180
<b>V-8 5.0 L</b>			2002; OE Type Thermostat; Eng. VIN 4 .....	◆14028	180
1999-1996; Premium Thermostat .....	◆○45119	195	2002; OE Exact Thermostat; Eng. VIN F .....	◆○48628	180
1999-1996; OE Type Thermostat .....	◆○14119	195	2002; OE Type Thermostat; Eng. VIN F .....	◆○14698	180
1995; Premium Thermostat .....	◆45359	195	2001-1996; Premium Thermostat .....	◆45028	180
	◆45358	180	2001-1996; OE Type Thermostat .....	◆14028	180
	◆45356	160	1995; Premium Thermostat .....	◆45849	195
1995; OE Type Thermostat .....	◆13359	195		◆45848	180
	◆13352	205	1995; OE Type Thermostat .....	◆13849	195
	◆13358	180		◆13848	180
	◆13356	160	<b>4-Cyl. 2.3 L</b>		
1995; Economy Thermostat .....	◆13009	195	1995; Premium Thermostat .....	◆45028	180
	◆13008	180	1995; OE Type Thermostat .....	◆14028	180
	◆13006	160	<b>4-Cyl. 2.4 L</b>		
<b>V-8 5.7 L</b>			2002-1996; Premium Thermostat .....	◆45028	180
2000-1996; Premium Thermostat .....	◆○45119	195	2002-1996; OE Type Thermostat .....	◆14028	180
2000-1996; OE Type Thermostat .....	◆○14119	195	<b>Classic</b>		
1995; Premium Thermostat .....	◆45359	195	<b>4-Cyl. 2.2 L</b>		
	◆45358	180	2005-2004; OE Exact Thermostat .....	◆○48628	180
	◆45356	160	2005-2004; OE Type Thermostat .....	◆○14698	180
1995; OE Type Thermostat .....	◆13359	195	<b>Cobalt</b>		
	◆13352	205	<b>4-Cyl. 2.0 L; 4-Cyl. 2.2 L</b>		
	◆13358	180	2010; OE Type Thermostat .....	◆○14698	180
	◆13356	160	2009-2005; OE Exact Thermostat .....	◆○48628	180
1995; Economy Thermostat .....	◆13009	195	2009-2005; OE Type Thermostat .....	◆○14698	180
	◆13008	180	<b>4-Cyl. 2.4 L</b>		
	◆13006	160	2008-2006; OE Exact Thermostat .....	◆○48628	180
<b>V-8 6.5 L Diesel</b>			2008-2006; OE Type Thermostat .....	◆○14698	180
2002-2001; OE Type Thermostat .....	②◆○14399	190	<b>Colorado</b>		
2000-1999; OE Type Thermostat .....	◆○14399	190	<b>4-Cyl. 2.8 L</b>		
1998-1997; Premium Thermostat .....	②◆45359	195	2006-2004; OE Exact Thermostat Water Outlet		
1998-1997; OE Type Thermostat .....	②◆13359	195	Assembly .....	◆○48718	180
1996; OE Type Thermostat; 2nd Design .....	②◆○14399	190	<b>4-Cyl. 2.9 L</b>		
1996; OE Type Thermostat; 1st Design .....	◆14039	195	2011-2007; OE Exact Thermostat Water Outlet		
1995; OE Type Thermostat .....	◆14039	195	Assembly .....	◆○48718	180
<b>V-8 7.4 L</b>			<b>5-Cyl. 3.5 L</b>		
2000-1996; Premium Thermostat .....	◆○45899	195	2006-2004; OE Exact Thermostat Water Outlet		
2000-1996; OE Type Thermostat .....	◆○13899	195	Assembly .....	◆○48718	180
1995; Premium Thermostat .....	◆45849	195	<b>5-Cyl. 3.7 L</b>		
	◆45848	180	2011-2007; OE Exact Thermostat Water Outlet		
	◆13849	195	Assembly .....	◆○48718	180
1995; OE Type Thermostat .....	◆13848	180	<b>V-8 5.3 L</b>		
<b>V-8 8.1 L</b>			2011; OE Exact Thermostat Water Outlet Assembly .....	◆○48718	180
2002-2001; Premium Thermostat .....	◆○45899	195	<b>Corsica</b>		
2002-2001; OE Type Thermostat .....	◆○13899	195	<b>4-Cyl. 2.2 L</b>		
<b>Camaro</b>			1996; Premium Thermostat .....	◆45028	180
<b>V-6 3.4 L</b>			1996; OE Type Thermostat .....	◆14028	180
1995; Premium Thermostat .....	◆45849	195	1995; Premium Thermostat .....	◆45849	195
	◆45848	180		◆45848	180
1995; OE Type Thermostat .....	◆13849	195	1995; OE Type Thermostat .....	◆13849	195
	◆13848	180		◆13848	180
<b>V-6 3.8 L</b>			<b>V-6 3.1 L</b>		
2002-1995; Premium Thermostat .....	◆45849	195	1996-1995; Premium Thermostat .....	◆○45899	195
	◆45848	180	1996-1995; OE Type Thermostat .....	◆○13899	195
2002-1995; OE Type Thermostat .....	◆13849	195	<b>Corvette</b>		
	◆13848	180	<b>V-8 5.7 L</b>		
<b>V-8 5.7 L</b>			2004; Heavy-Duty Thermostat .....	◆○14948	186
2002-1998; Thermostat Water Outlet Assembly; W/OE			2003; Thermostat Water Outlet Assembly; W/OE or Most		
or Most Aftermarket Water Pumps .....	◆○14298	186	Aftermarket Water Pumps .....	◆○14298	186
2002-1998; Heavy-Duty Thermostat; W/GM					
Replacement Water Pump .....	◆○14948	186			
1997-1995; Premium Thermostat .....	◆○45218	180			
1997-1995; OE Type Thermostat .....	◆○14218	180			

◆ OE Temperature.  
○ Seal Included.

◆ Alternate Temperature.  
② Two Required.



## Thermostats for Passenger Cars and Light Trucks (1990 and Newer)

Application	Part Number	Temp°F	Application	Part Number	Temp°F
<b>Chevrolet - Continued</b>			<b>Chevrolet - Continued</b>		
<b>Corvette - Continued</b>			<b>Express - Continued</b>		
<b>V-8 5.7 L - Continued</b>			<b>V-8 5.7 L - Continued</b>		
2003; Heavy-Duty Thermostat; W/GM Replacement Water Pump .....	◆○14948	186	1996; Economy Thermostat .....	◆13009	195
2002; Thermostat Water Outlet Assembly; W/OE or Most Aftermarket Water Pumps; Eng. VIN G .....	◆○14298	186	◆13008	180	
2002; Heavy-Duty Thermostat; W/GM Replacement Water Pump; Eng. VIN G .....	◆○14948	186	◆13006	160	
2001-1997; Thermostat Water Outlet Assembly; W/OE or Most Aftermarket Water Pumps .....	◆○14298	186	<b>V-8 6.0 L</b>		
2001-1997; Heavy-Duty Thermostat; W/GM Replacement Water Pump .....	◆○14948	186	2006-2004; Heavy-Duty Thermostat .....	◆○14948	186
1996; Premium Thermostat .....	◆○45218	180	2003; Thermostat Water Outlet Assembly; W/OE or Most Aftermarket Water Pumps .....	◆○14298	186
1996; OE Type Thermostat .....	◆○14218	180	2003; Heavy-Duty Thermostat; W/GM Replacement Water Pump .....	◆○14948	186
1995; OE Type Thermostat; Eng. VIN J .....	◆○14068	180	<b>V-8 6.5 L Diesel</b>		
1995; Premium Thermostat; Eng. VIN P .....	◆○45218	180	2002-1999; OE Type Thermostat .....	②◆○14399	190
1995; OE Type Thermostat; Eng. VIN P .....	◆○14218	180	1998-1997; Premium Thermostat .....	◆45359	195
<b>V-8 6.0 L</b>			1998-1997; OE Type Thermostat .....	◆13359	195
2007-2005; Heavy-Duty Thermostat .....	◆○14948	186	1996; Premium Thermostat .....	②◆45359	195
<b>V-8 6.2 L</b>			1996; OE Type Thermostat .....	②◆13359	195
2008; Heavy-Duty Thermostat .....	◆○14948	186	<b>V-8 6.6 L Diesel</b>		
<b>V-8 7.0 L</b>			2011-2010; OE Type Thermostat .....	◆○14728	185
2008-2006; Heavy-Duty Thermostat .....	◆○14948	186	2009-2006; OE Type Thermostat - Front .....	◆○14738	180
<b>Equinox</b>			2009-2006; OE Type Thermostat - Rear .....	◆○14728	185
<b>4-Cyl. 2.4 L</b>			2009-2006; OE Type Thermostat - Rear .....	◆○14738	180
2011; OE Exact Thermostat .....	◆○48628	180	<b>V-8 7.4 L</b>		
2011; OE Type Thermostat .....	◆○14698	180	2000-1996; Premium Thermostat .....	◆○45899	195
2010; OE Type Thermostat .....	◆○14698	180	2000-1996; OE Type Thermostat .....	◆○13899	195
<b>V-6 3.4 L</b>			<b>V-8 8.1 L</b>		
2009-2005; Premium Thermostat .....	◆○45899	195	2002-2001; Premium Thermostat .....	◆○45899	195
2009-2005; OE Type Thermostat .....	◆○13899	195	2002-2001; OE Type Thermostat .....	◆○13899	195
<b>Express</b>			<b>G Series Van</b>		
<b>V-6 4.3 L</b>			<b>V-6 4.3 L</b>		
2011-1997; Premium Thermostat .....	◆○45119	195	1998-1997; Premium Thermostat .....	◆○45119	195
2011-1997; OE Type Thermostat .....	◆○14119	195	1998-1997; OE Type Thermostat .....	◆○14119	195
1996; Premium Thermostat .....	◆45359	195	1996; Premium Thermostat; Eng. VIN W .....	◆○45119	195
◆45358	180		1996; OE Type Thermostat; Eng. VIN W .....	◆○14119	195
◆45356	160		1996; Premium Thermostat; Eng. VIN Z .....	◆45359	195
1996; OE Type Thermostat .....	◆13359	195	◆45358	180	
◆13352	205		◆45356	160	
◆13358	180		1996; OE Type Thermostat; Eng. VIN Z .....	◆13359	195
◆13356	160		◆13352	205	
1996; Economy Thermostat .....	◆13009	195	◆13358	180	
◆13008	180		◆13356	160	
◆13006	160		1996; Economy Thermostat; Eng. VIN Z .....	◆13009	195
<b>V-8 4.8 L</b>			◆13008	180	
2006-2004; Heavy-Duty Thermostat .....	◆○14948	186	◆13006	160	
2003; Thermostat Water Outlet Assembly; W/OE or Most Aftermarket Water Pumps .....	◆○14298	186	<b>V-8 5.0 L</b>		
2003; Heavy-Duty Thermostat; W/GM Replacement Water Pump .....	◆○14948	186	1998-1996; Premium Thermostat .....	◆○45119	195
<b>V-8 5.0 L</b>			1998-1996; OE Type Thermostat .....	◆○14119	195
2002-1996; Premium Thermostat .....	◆○45119	195	1995; Premium Thermostat .....	◆45359	195
2002-1996; OE Type Thermostat .....	◆○14119	195	◆45358	180	
<b>V-8 5.3 L</b>			◆45356	160	
2006-2004; Heavy-Duty Thermostat .....	◆○14948	186	1995; OE Type Thermostat .....	◆13359	195
2003; Thermostat Water Outlet Assembly; W/OE or Most Aftermarket Water Pumps .....	◆○14298	186	◆13352	205	
2003; Heavy-Duty Thermostat; W/GM Replacement Water Pump .....	◆○14948	186	◆13358	180	
<b>V-8 5.7 L</b>			◆13356	160	
2002-1997; Premium Thermostat .....	◆○45119	195	1995; OE Type Thermostat .....	◆13009	195
2002-1997; OE Type Thermostat .....	◆○14119	195	◆13008	180	
1996; Premium Thermostat .....	◆45359	195	◆13006	160	
◆45358	180		<b>V-8 5.0 L</b>		
◆45356	160		1998-1996; Premium Thermostat .....	◆○45119	195
1996; OE Type Thermostat .....	◆13359	195	1998-1996; OE Type Thermostat .....	◆○14119	195
◆13352	205		1995; Premium Thermostat .....	◆45359	195
◆13358	180		◆45358	180	
◆13356	160		◆45356	160	
<b>V-8 5.7 L</b>			1995; OE Type Thermostat .....	◆13359	195
1998-1997; Premium Thermostat .....	◆○45119	195	◆13352	205	
1998-1997; OE Type Thermostat .....	◆○14119	195	◆13358	180	
<b>V-8 5.7 L</b>			◆13009	195	
1998-1997; Premium Thermostat .....	◆○45119	195	◆13008	180	
1998-1997; OE Type Thermostat .....	◆○14119	195	◆13006	160	

◆ OE Temperature.  
 ◇ Alternate Temperature.

○ Seal Included.  
 ② Two Required.

# Thermostats for Passenger Cars and Light Trucks (1990 and Newer)

Application	Part Number	Temp°F	Application	Part Number	Temp°F
<b>Chevrolet - Continued</b>			<b>Chevrolet - Continued</b>		
<b>G Series Van - Continued</b>			<b>Impala SS</b>		
<b>V-8 5.7 L - Continued</b>			<b>V-8 5.7 L</b>		
1996; Premium Thermostat; Eng. VIN K .....	◆45359	195	1996-1995; Premium Thermostat .....	◆○45218	180
	◇45358	180	1996-1995; OE Type Thermostat .....	◆○14218	180
	◇45356	160	<b>LLV (Postal Vehicle)</b>		
1996; OE Type Thermostat; Eng. VIN K .....	◆13359	195	<b>4-Cyl. 2.2 L</b>		
	◇13352	205	1995; Premium Thermostat .....	◆45849	195
	◇13358	180		◇45848	180
	◇13356	160	1995; OE Type Thermostat .....	◆13849	195
1996; Economy Thermostat; Eng. VIN K .....	◆13009	195		◇13848	180
	◇13008	180	<b>Lumina</b>		
	◇13006	160	<b>V-6 3.1 L</b>		
1996; Premium Thermostat; Eng. VIN R .....	◆○45119	195	2001-1995; Premium Thermostat .....	◆○45899	195
1996; OE Type Thermostat; Eng. VIN R .....	◆○14119	195	2001-1995; OE Type Thermostat .....	◆○13899	195
1995; Premium Thermostat .....	◆45359	195	<b>V-6 3.4 L</b>		
	◇45358	180	1997-1996; Premium Thermostat .....	◆45849	195
	◇45356	160		◇45848	180
1995; OE Type Thermostat .....	◆13359	195		◆13849	195
	◇13352	205		◇13848	180
	◇13358	180	1997-1996; OE Type Thermostat .....	◆13849	195
	◇13356	160		◇13848	180
1995; Economy Thermostat .....	◆13009	195	1995; Premium Thermostat .....	◆○45899	195
	◇13008	180	1995; OE Type Thermostat .....	◆○13899	195
	◇13006	160	<b>V-6 3.8 L</b>		
<b>V-8 6.5 L Diesel</b>			1999-1998; Premium Thermostat .....	◆45849	195
1998-1997; OE Type Thermostat .....	◆○14399	190		◇45848	180
1996-1995; OE Type Thermostat .....	◆14429	190	1999-1998; OE Type Thermostat .....	◆13849	195
				◇13848	180
<b>V-8 7.4 L</b>			<b>Lumina APV</b>		
1998-1997; Premium Thermostat .....	◆○45899	195	<b>V-6 3.1 L</b>		
1998-1997; OE Type Thermostat .....	◆○13899	195	1995; Premium Thermostat .....	◆○45899	195
1996; Premium Thermostat; Eng. VIN J .....	◆○45899	195	1995; OE Type Thermostat .....	◆○13899	195
1996; OE Type Thermostat; Eng. VIN J .....	◆○13899	195	<b>V-6 3.4 L</b>		
1996; Premium Thermostat; Eng. VIN N .....	◆45849	195	1996; Premium Thermostat .....	◆○45899	195
	◇45848	180	1996; OE Type Thermostat .....	◆○13899	195
1996; OE Type Thermostat; Eng. VIN N .....	◆13849	195	<b>V-6 3.8 L</b>		
	◇13848	180	1995; Premium Thermostat .....	◆45849	195
1995; Premium Thermostat .....	◆45849	195		◇45848	180
	◇45848	180		◆13849	195
1995; OE Type Thermostat .....	◆13849	195		◇13848	180
	◇13848	180	<b>Malibu</b>		
<b>HHR</b>			<b>4-Cyl. 2.2 L</b>		
<b>4-Cyl. 2.0 L</b>			2010; OE Type Thermostat .....	◆○14698	180
2010; OE Type Thermostat .....	◆○14698	180	2009-2008; OE Exact Thermostat .....	◆○48628	180
2009-2008; OE Exact Thermostat .....	◆○48628	180	2009-2008; OE Type Thermostat .....	◆○14698	180
2009-2008; OE Type Thermostat .....	◆○14698	180	<b>4-Cyl. 2.4 L</b>		
<b>4-Cyl. 2.2 L</b>			2011-2006; OE Exact Thermostat .....	◆○48628	180
2011-2006; OE Exact Thermostat .....	◆○48628	180	2011-2006; OE Type Thermostat .....	◆○14698	180
2011-2006; OE Type Thermostat .....	◆○14698	180	<b>4-Cyl. 2.4 L Electric Assist</b>		
<b>4-Cyl. 2.4 L</b>			2009-2008; OE Exact Thermostat .....	◆○48628	180
2011; OE Exact Thermostat .....	◆○48628	180	2009-2008; OE Type Thermostat .....	◆○14698	180
2011; OE Type Thermostat .....	◆○14698	180	<b>V-6 3.1 L</b>		
2010; OE Type Thermostat .....	◆○14698	180	2003-1997; Premium Thermostat .....	◆○45899	195
2009-2006; OE Exact Thermostat .....	◆○48628	180	2003-1997; OE Type Thermostat .....	◆○13899	195
2009-2006; OE Type Thermostat .....	◆○14698	180	<b>V-6 3.5 L</b>		
<b>Impala</b>			2010-2007; OE Exact Thermostat .....	◆○48808	185
<b>V-6 3.4 L</b>			2006-2004; Premium Thermostat .....	◆○45899	195
2005-2000; Premium Thermostat .....	◆○45899	195	2006-2004; OE Type Thermostat .....	◆○13899	195
2005-2000; OE Type Thermostat .....	◆○13899	195	<b>V-6 3.9 L</b>		
<b>V-6 3.5 L</b>			2007-2006; OE Exact Thermostat .....	◆○48808	185
2011-2006; OE Exact Thermostat .....	◆○48808	185	<b>Metro</b>		
<b>V-6 3.8 L</b>			<b>3-Cyl. 1.0 L</b>		
2005-2000; Premium Thermostat .....	◆45849	195	2000-1998; Premium Thermostat .....	◆45849	195
	◇45848	180		◇45848	180
	◆13849	195	2000-1998; OE Type Thermostat .....	◆13849	195
2005-2000; OE Type Thermostat .....	◇13848	180		◇13848	180
<b>V-6 3.9 L</b>					
2011-2006; OE Exact Thermostat .....	◆○48808	185			
<b>V-8 5.3 L</b>					
2009-2006; Heavy-Duty Thermostat .....	◆○14948	186			

◆ OE Temperature.  
○ Seal Included.

◇ Alternate Temperature.

# Thermostats for Passenger Cars and Light Trucks (1990 and Newer)

Application	Part Number	Temp°F	Application	Part Number	Temp°F
<b>Chevrolet - Continued</b>			<b>Chevrolet - Continued</b>		
<b>Metro - Continued</b>			<b>P Series Van - Continued</b>		
<b>4-Cyl. 1.3 L</b>			<b>V-8 5.7 L - Continued</b>		
2001-2000; Premium Thermostat .....	◆45849	195	1995; Premium Thermostat .....	◆45359	195
	◇45848	180		◇45358	180
2001-2000; OE Type Thermostat .....	◆13849	195		◇45356	160
	◇13848	180	1995; OE Type Thermostat .....	◆13359	195
1999; OE Exact Thermostat .....	◆○48529	190		◇13352	205
1999; Premium Thermostat .....	◆45849	195		◇13358	180
	◇45848	180	1995; Economy Thermostat .....	◇13356	160
1999; OE Type Thermostat .....	◆13849	195		◆13009	195
	◇13848	180		◇13008	180
1998; Premium Thermostat .....	◆45849	195		◇13006	160
	◇45848	180	<b>V-8 6.5 L Diesel</b>		
1998; OE Type Thermostat .....	◆13849	195	1999-1996; OE Type Thermostat .....	◆13479	195
	◇13848	180	1995; OE Type Thermostat; Eng. VIN F .....	◆14039	195
<b>Monte Carlo</b>			<b>V-8 7.4 L</b>		
<b>V-6 3.1 L</b>			1999-1996; Premium Thermostat .....	◆○45899	195
1999-1995; Premium Thermostat .....	◆○45899	195	1999-1996; OE Type Thermostat .....	◆○13899	195
1999-1995; OE Type Thermostat .....	◆○13899	195	1995; Premium Thermostat .....	◆45849	195
<b>V-6 3.4 L</b>				◇45848	180
2005-2003; OE Type Thermostat .....	◆○13899	195	1995; OE Type Thermostat .....	◆13849	195
2002; Premium Thermostat .....	◆○45899	195		◇13848	180
2002; OE Type Thermostat .....	◆○13899	195	<b>Prizm</b>		
2001-2000; OE Type Thermostat .....	◆○13899	195	<b>4-Cyl. 1.8 L</b>		
1997-1996; Premium Thermostat .....	◆45849	195	2002-2001; OE Type Thermostat .....	◆14077	170
	◇45848	180		◇14078	180
1997-1996; OE Type Thermostat .....	◆13849	195	2000; OE Exact Thermostat .....	◆48128	180
	◇13848	180	2000; OE Type Thermostat .....	◆14078	180
1995; Premium Thermostat .....	◆○45899	195		◇14077	170
1995; OE Type Thermostat .....	◆○13899	195	1999-1998; OE Type Thermostat .....	◆14077	170
<b>V-6 3.5 L</b>				◇14078	180
2007-2006; OE Exact Thermostat .....	◆○48808	185	<b>S Series Pickup</b>		
<b>V-6 3.8 L</b>			<b>4-Cyl. 2.2 L</b>		
2005-1998; Premium Thermostat .....	◆45849	195	2003-1995; Premium Thermostat .....	◆45849	195
	◇45848	180		◇45848	180
2005-1998; OE Type Thermostat .....	◆13849	195	2003-1995; OE Type Thermostat .....	◆13849	195
	◇13848	180		◇13848	180
<b>V-6 3.9 L</b>			<b>V-6 4.3 L</b>		
2006; OE Exact Thermostat .....	◆○48808	185	2004-1996; Premium Thermostat .....	◆○45119	195
<b>V-8 5.3 L</b>			2004-1996; OE Type Thermostat .....	◆○14119	195
2007-2006; Heavy-Duty Thermostat .....	◆○14948	186	1995; Premium Thermostat; Eng. VIN W .....	◆45849	195
<b>P Series Van</b>				◇45848	180
<b>V-6 4.3 L</b>			1995; OE Type Thermostat; Eng. VIN W .....	◆13849	195
1999-1996; Premium Thermostat .....	◆○45119	195		◇13848	180
1999-1996; OE Type Thermostat .....	◆○14119	195	1995; Premium Thermostat; Eng. VIN Z .....	◆45359	195
1995; Premium Thermostat .....	◆45359	195		◇45358	180
	◇45356	160	1995; OE Type Thermostat; Eng. VIN Z .....	◇45356	160
1995; OE Type Thermostat .....	◆13359	195		◆13352	205
	◇13352	205	1995; Economy Thermostat; Eng. VIN Z .....	◇13358	180
	◇13358	180		◇13356	160
	◇13356	160		◆13009	195
1995; Economy Thermostat .....	◆13009	195		◇13008	180
	◇13008	180		◇13006	160
	◇13006	160	<b>Silverado Series Pickup</b>		
<b>V-8 5.7 L</b>			<b>V-6 4.3 L</b>		
1999-1997; Premium Thermostat .....	◆○45119	195	2011-2003; Premium Thermostat .....	◆○45119	195
1999-1997; OE Type Thermostat .....	◆○14119	195	2011-2003; OE Type Thermostat .....	◆○14119	195
1996; Premium Thermostat; Eng. VIN K .....	◆45359	195	2002; Premium Thermostat; Eng. VIN W .....	◆○45119	195
	◇45358	180	2002; OE Type Thermostat; Eng. VIN W .....	◆○14119	195
	◇45356	160	2001-1999; Premium Thermostat .....	◆○45119	195
1996; OE Type Thermostat; Eng. VIN K .....	◆13359	195	2001-1999; OE Type Thermostat .....	◆○14119	195
	◇13352	205	<b>V-8 4.8 L</b>		
	◇13358	180	2006-2004; Heavy-Duty Thermostat .....	◆○14948	186
	◇13356	160	2003-1999; Thermostat Water Outlet Assembly; W/OE or Most Aftermarket Water Pumps .....	◆○14298	186
1996; Economy Thermostat; Eng. VIN K .....	◆13009	195	2003-1999; Heavy-Duty Thermostat; W/GM Replacement Water Pump .....	◆○14948	186
	◇13008	180	<b>V-8 5.3 L</b>		
	◇13006	160	2006-1999; Thermostat Water Outlet Assembly; W/OE or Most Aftermarket Water Pumps .....	◆○14298	186
1996; Premium Thermostat; Eng. VIN R .....	◆○45119	195			
1996; OE Type Thermostat; Eng. VIN R .....	◆○14119	195			

◆ OE Temperature.  
○ Seal Included.

◇ Alternate Temperature.

# Thermostats for Passenger Cars and Light Trucks (1990 and Newer)

Application	Part Number	Temp°F	Application	Part Number	Temp°F
<b>Chevrolet - Continued</b>			<b>Chevrolet - Continued</b>		
<b>Silverado Series Pickup - Continued</b>			<b>Suburban - Continued</b>		
<b>V-8 5.3 L - Continued</b>			<b>V-8 8.1 L</b>		
2006-1999; Heavy-Duty Thermostat; W/GM Replacement Water Pump .....	◆○14948	186	2006-2001; Premium Thermostat .....	◆○45899	195
<b>V-8 5.3 L Electric Assist</b>			2006-2001; OE Type Thermostat .....	◆○13899	195
2006-2004; Heavy-Duty Thermostat .....	◆○14948	186	<b>Tahoe</b>		
<b>V-8 6.0 L</b>			<b>V-8 4.8 L</b>		
2006-2004; Heavy-Duty Thermostat .....	◆○14948	186	2006-2004; Heavy-Duty Thermostat .....	◆○14948	186
2003-1999; Thermostat Water Outlet Assembly; W/OE or Most Aftermarket Water Pumps .....	◆○14298	186	2003-2000; Thermostat Water Outlet Assembly; W/OE or Most Aftermarket Water Pumps .....	◆○14298	186
2003-1999; Heavy-Duty Thermostat; W/GM Replacement Water Pump .....	◆○14948	186	2003-2000; Heavy-Duty Thermostat; W/GM Replacement Water Pump .....	◆○14948	186
<b>V-8 6.5 L Diesel</b>			<b>V-8 5.3 L</b>		
1999; OE Type Thermostat .....	②◆○14399	190	2006-2000; Thermostat Water Outlet Assembly; W/OE or Most Aftermarket Water Pumps .....	◆○14298	186
<b>V-8 6.6 L Diesel</b>			2006-2000; Heavy-Duty Thermostat; W/GM Replacement Water Pump .....	◆○14948	186
2011-2001; OE Type Thermostat - Front .....	◆○14728	185	<b>V-8 5.7 L</b>		
2011-2001; OE Type Thermostat - Rear .....	◆○14738	180	2000-1996; Premium Thermostat .....	◆○45119	195
<b>V-8 8.1 L</b>			2000-1996; OE Type Thermostat .....	◆○14119	195
2007-2001; Premium Thermostat .....	◆○45899	195	1995; Premium Thermostat .....	◆45359	195
2007-2001; OE Type Thermostat .....	◆○13899	195	◆45358	180	
<b>SSR</b>			◆45356	160	
<b>V-8 5.3 L</b>			◆13359	195	
2004; Heavy-Duty Thermostat .....	◆○14948	186	◆13352	205	
2003; Thermostat Water Outlet Assembly; W/OE or Most Aftermarket Water Pumps .....	◆○14298	186	◆13358	180	
2003; Heavy-Duty Thermostat; W/GM Replacement Water Pump .....	◆○14948	186	◆13356	160	
<b>V-8 6.0 L</b>			◆13009	195	
2006-2005; Heavy-Duty Thermostat .....	◆○14948	186	◆13008	180	
<b>Suburban</b>			◆13006	160	
<b>V-8 5.3 L</b>			<b>V-8 6.0 L</b>		
2011; Heavy-Duty Thermostat .....	◆○14948	186	2006-2004; Heavy-Duty Thermostat .....	◆○14948	186
2006-2005; Heavy-Duty Thermostat .....	◆○14948	186	2003-2000; Thermostat Water Outlet Assembly; W/OE or Most Aftermarket Water Pumps .....	◆○14298	186
2004; Thermostat Water Outlet Assembly; W/Most Aftermarket Water Pumps .....	◆○14298	186	2003-2000; Heavy-Duty Thermostat; W/GM Replacement Water Pump .....	◆○14948	186
2004; Heavy-Duty Thermostat; W/OE or GM Replacement Water Pump .....	◆○14948	186	<b>V-8 5.7 L</b>		
2003-2000; Thermostat Water Outlet Assembly; W/OE or Most Aftermarket Water Pumps .....	◆○14298	186	1999-1996; Premium Thermostat .....	◆○45119	195
2003-2000; Heavy-Duty Thermostat; W/GM Replacement Water Pump .....	◆○14948	186	1999-1996; OE Type Thermostat .....	◆○14119	195
<b>V-8 5.7 L</b>			1995; Premium Thermostat .....	◆45359	195
1999-1996; Premium Thermostat .....	◆○45119	195	◆45358	180	
1999-1996; OE Type Thermostat .....	◆○14119	195	◆45356	160	
1995; Premium Thermostat .....	◆45359	195	◆13359	195	
	◆45358	180	◆13352	205	
1995; OE Type Thermostat .....	◆13359	195	◆13358	180	
	◆13352	205	◆13356	160	
	◆13358	180	◆13009	195	
	◆13356	160	◆13008	180	
1995; Economy Thermostat .....	◆13009	195	◆13006	160	
	◆13008	180	<b>V-8 6.0 L</b>		
	◆13006	160	2006-2004; Heavy-Duty Thermostat .....	◆○14948	186
<b>V-8 6.0 L</b>			2003-2000; Thermostat Water Outlet Assembly; W/OE or Most Aftermarket Water Pumps .....	◆○14298	186
2006-2004; Heavy-Duty Thermostat .....	◆○14948	186	2003-2000; Heavy-Duty Thermostat; W/GM Replacement Water Pump .....	◆○14948	186
2003-2000; Thermostat Water Outlet Assembly; W/OE or Most Aftermarket Water Pumps .....	◆○14298	186	<b>V-8 6.5 L Diesel</b>		
2003-2000; Heavy-Duty Thermostat; W/GM Replacement Water Pump .....	◆○14948	186	1999-1997; Premium Thermostat .....	②◆45359	195
<b>V-8 6.5 L Diesel</b>			1999-1997; OE Type Thermostat .....	②◆13359	195
1999-1997; Premium Thermostat .....	②◆45359	195	1996-1995; OE Type Thermostat .....	◆14039	195
1999-1997; OE Type Thermostat .....	②◆13359	195	<b>V-8 7.4 L</b>		
1996-1995; OE Type Thermostat .....	◆14039	195	1999-1996; Premium Thermostat .....	◆○45899	195
<b>V-8 7.4 L</b>			1999-1996; OE Type Thermostat .....	◆○13899	195
1999-1996; Premium Thermostat .....	◆○45899	195	1995; Premium Thermostat .....	◆45849	195
1999-1996; OE Type Thermostat .....	◆○13899	195	◆45848	180	
1995; Premium Thermostat .....	◆45849	195	◆13849	195	
	◆45848	180	◆13848	180	
1995; OE Type Thermostat .....	◆13849	195	<b>Chrysler</b>		
	◆13848	180	<b>300</b>		
<b>V-8 7.4 L</b>			<b>V-6 2.7 L</b>		
1999-1996; Premium Thermostat .....	◆○45899	195	2010-2005; OE Type Thermostat .....	◆14349	190
1999-1996; OE Type Thermostat .....	◆○13899	195			
1995; Premium Thermostat .....	◆45849	195			
	◆45848	180			
1995; OE Type Thermostat .....	◆13849	195			
	◆13848	180			

◆ OE Temperature.  
② Two Required.

○ Seal Included.  
◆ Alternate Temperature.

## Thermostats for Passenger Cars and Light Trucks (1990 and Newer)

Application	Part Number	Temp°F	Application	Part Number	Temp°F
<b>Chrysler - Continued</b>			<b>Chrysler - Continued</b>		
<b>300 - Continued</b>			<b>Lebaron</b>		
V-6 3.5 L			V-6 3.0 L		
2010; OE Exact Thermostat .....	◆49108	180	1995; Premium Thermostat .....	◆45869	195
2009-2008; OE Exact Thermostat .....	◆49108	180	◆45868	180	
2009-2008; OE Type Thermostat .....	◆○14288	180	1995; OE Type Thermostat .....	◆13869	195
2007-2006; OE Exact Thermostat .....	◆49108	180	◆13868	180	
2005; OE Type Thermostat .....	◆14358	180			
V-8 5.7 L; V-8 6.1 L			<b>LHS</b>		
2010-2005; OE Exact Thermostat .....	◆○48792	203	V-6 3.5 L		
<b>300M</b>			2001-1999; OE Type Thermostat .....	◆14358	180
V-6 3.5 L			1997-1995; Premium Thermostat .....	◆45209	195
2004-1999; OE Type Thermostat .....	◆14358	180	1997-1995; OE Type Thermostat .....	◆14209	195
<b>Aspen</b>			<b>New Yorker</b>		
V-8 4.7 L			V-6 3.5 L		
2009-2007; OE Type Thermostat .....	◆○14369	195	1996-1995; Premium Thermostat .....	◆45209	195
V-8 5.7 L			1996-1995; OE Type Thermostat .....	◆14209	195
2009-2007; OE Exact Thermostat .....	◆○48792	203	<b>Pacifica</b>		
V-8 5.7 L Electric Assist			V-6 3.5 L		
2009; OE Exact Thermostat .....	◆○48792	203	2006-2005; OE Type Thermostat .....	◆14789	195
<b>Cirrus</b>			2004; OE Type Thermostat .....	◆14358	180
4-Cyl. 2.4 L			V-6 3.8 L		
2000; Premium Thermostat .....	◆45209	195	2008; Premium Thermostat .....	◆45209	195
2000; OE Type Thermostat .....	◆14209	195	2008; OE Type Thermostat .....	◆14209	195
1997-1995; Premium Thermostat .....	◆45209	195	2007-2005; OE Type Thermostat .....	◆14789	195
1997-1995; OE Type Thermostat .....	◆14209	195	V-6 4.0 L		
V-6 2.5 L			2008-2007; Premium Thermostat .....	◆45209	195
2000-1995; OE Type Thermostat .....	◆14128	180	2008-2007; OE Type Thermostat .....	◆14209	195
	◆14127	170	<b>Prowler</b>		
<b>Concorde</b>			V-6 3.5 L		
V-6 2.7 L			2002-2001; OE Type Thermostat .....	◆14358	180
2004-1998; OE Type Thermostat .....	◆14349	190	<b>PT Cruiser</b>		
V-6 3.2 L			4-Cyl. 2.4 L		
2001-1998; OE Type Thermostat .....	◆14358	180	2007-2001; Premium Thermostat .....	◆45209	195
V-6 3.3 L			2007-2001; OE Type Thermostat .....	◆14209	195
1996-1995; Premium Thermostat .....	◆45209	195	<b>Sebring</b>		
1996-1995; OE Type Thermostat .....	◆14209	195	4-Cyl. 2.0 L		
V-6 3.5 L			1999-1995; Premium Thermostat .....	◆45209	195
2004-2002; OE Type Thermostat .....	◆14358	180	1999-1995; OE Type Thermostat .....	◆14209	195
1997-1995; Premium Thermostat .....	◆45209	195	4-Cyl. 2.4 L		
1997-1995; OE Type Thermostat .....	◆14209	195	2007; OE Type Thermostat .....	◆○14678	180
<b>Crossfire</b>			2006; Premium Thermostat .....	◆45209	195
V-6 3.2 L			2006; OE Type Thermostat .....	◆14209	195
2008-2004; Thermostat Water Outlet Assembly .....	◆○14569	188	2005-2001; Premium Thermostat; W/DOHC Eng. ....	◆45209	195
<b>Grand Voyager</b>			2005-2001; OE Type Thermostat; W/DOHC Eng. ....	◆14209	195
V-6 3.3 L			2005-2001; OE Exact Thermostat; W/SOHC Eng. ....	◆○48239	190
2000; Premium Thermostat .....	◆45209	195	2005-2001; OE Type Thermostat; W/SOHC Eng. ....	◆14389	190
2000; OE Type Thermostat .....	◆14209	195	1999-1996; Premium Thermostat .....	◆45209	195
<b>Intrepid</b>			1999-1996; OE Type Thermostat .....	◆14209	195
V-6 2.7 L (Canada)			V-6 2.5 L		
2004-1998; OE Type Thermostat .....	◆14349	190	2000-1995; OE Type Thermostat .....	◆14128	180
V-6 3.2 L (Canada)				◆14127	170
2001-1998; OE Type Thermostat .....	◆14358	180	V-6 2.7 L		
V-6 3.3 L (Canada)			2010-2001; OE Type Thermostat .....	◆14349	190
1997-1995; Premium Thermostat .....	◆45209	195	V-6 3.0 L		
1997-1995; OE Type Thermostat .....	◆14209	195	2005-2001; OE Type Thermostat .....	◆14128	180
V-6 3.5 L (Canada)				◆14127	170
2004-2000; OE Type Thermostat .....	◆14358	180	V-6 3.5 L		
1997-1995; Premium Thermostat .....	◆45209	195	2010; OE Exact Thermostat .....	◆49108	180
1997-1995; OE Type Thermostat .....	◆14209	195	2010; Premium Thermostat .....	◆45209	195
2004-2000; OE Type Thermostat .....	◆14358	180	2010; OE Type Thermostat .....	◆14209	195
1997-1995; Premium Thermostat .....	◆45209	195	2009-2007; Premium Thermostat .....	◆45209	195
1997-1995; OE Type Thermostat .....	◆14209	195	2009-2007; OE Type Thermostat .....	◆14209	195
<b>Town &amp; Country Van</b>			V-6 3.3 L		
			2010-2007; Premium Thermostat .....	◆45209	195
			2010-2007; OE Type Thermostat .....	◆14209	195
			2006-2001; OE Type Thermostat .....	◆14789	195

◆ OE Temperature.  
 ◆ Alternate Temperature.

○ Seal Included.

## Thermostats for Passenger Cars and Light Trucks (1990 and Newer)

Application	Part Number	Temp°F	Application	Part Number	Temp°F
<b>Chrysler - Continued</b>			<b>Dodge - Continued</b>		
<b>Town &amp; Country Van - Continued</b>			<b>Caravan - Continued</b>		
<b>V-6 3.3 L - Continued</b>			<b>4-Cyl. 2.4 L - Continued</b>		
2000-1996; Premium Thermostat .....	◆45209	195	2007; OE Type Thermostat .....	◆14209	195
2000-1996; OE Type Thermostat .....	◆14209	195	2006; OE Type Thermostat .....	◆14789	195
<b>V-6 3.8 L</b>			2005-2002; Premium Thermostat .....	◆45209	195
2010-2007; Premium Thermostat .....	◆45209	195	2005-2002; OE Type Thermostat .....	◆14209	195
2010-2007; OE Type Thermostat .....	◆14209	195	2001; OE Type Thermostat .....	◆14789	195
2006-2001; OE Type Thermostat .....	◆14789	195	2000-1996; Premium Thermostat .....	◆45209	195
2000-1995; Premium Thermostat .....	◆45209	195	2000-1996; OE Type Thermostat .....	◆14209	195
2000-1995; OE Type Thermostat .....	◆14209	195	<b>4-Cyl. 2.5 L</b>		
<b>V-6 4.0 L</b>			1995; Premium Thermostat .....	◆45789	195
2010; OE Type Thermostat .....	◆14209	195	◆45788	180	
2009-2008; Premium Thermostat .....	◆45209	195	1995; OE Type Thermostat .....	◆13789	195
2009-2008; OE Type Thermostat .....	◆14209	195	◆13788	180	
<b>Voyager</b>			<b>V-6 3.0 L</b>		
<b>4-Cyl. 2.4 L</b>			2000-1995; Premium Thermostat .....	◆45869	195
2003-2000; Premium Thermostat .....	◆45209	195	◆45868	180	
2003-2000; OE Type Thermostat .....	◆14209	195	2000-1995; OE Type Thermostat .....	◆13869	195
<b>V-6 3.0 L</b>			◆13868	180	
2000; Premium Thermostat .....	◆45869	195	<b>V-6 3.3 L</b>		
◆45868	180		2007; Premium Thermostat .....	◆45209	195
2000; OE Type Thermostat .....	◆13869	195	2007; OE Type Thermostat .....	◆14209	195
◆13868	180		2006-2001; OE Type Thermostat .....	◆14789	195
<b>V-6 3.3 L</b>			2000-1995; Premium Thermostat .....	◆45209	195
2003-2001; OE Type Thermostat .....	◆14789	195	2000-1995; OE Type Thermostat .....	◆14209	195
2000; Premium Thermostat .....	◆45209	195	<b>V-6 3.8 L</b>		
2000; OE Type Thermostat .....	◆14209	195	1999-1996; Premium Thermostat .....	◆45209	195
<b>Dodge</b>			1999-1996; OE Type Thermostat .....	◆14209	195
<b>Avenger</b>			<b>Challenger</b>		
<b>4-Cyl. 2.0 L</b>			<b>V-6 3.5 L</b>		
1999-1995; Premium Thermostat .....	◆45209	195	2010; OE Exact Thermostat .....	◆49108	180
1999-1995; OE Type Thermostat .....	◆14209	195	2009; OE Exact Thermostat .....	◆49108	180
<b>V-6 2.5 L</b>			2009; OE Type Thermostat .....	◆○14288	180
2000-1995; OE Type Thermostat .....	◆14128	180	<b>V-8 5.7 L</b>		
◆14127	170		2010-2009; OE Exact Thermostat .....	◆○48792	203
<b>V-6 2.7 L</b>			<b>V-8 6.1 L</b>		
2009-2008; OE Type Thermostat .....	◆14349	190	2010-2008; OE Exact Thermostat .....	◆○48792	203
<b>V-6 3.5 L</b>			<b>Charger</b>		
2010-2008; Premium Thermostat .....	◆45209	195	<b>V-6 2.7 L</b>		
2010-2008; OE Type Thermostat .....	◆14209	195	2010-2006; OE Type Thermostat .....	◆14349	190
<b>B Series Van</b>			<b>V-6 3.5 L</b>		
<b>V-6 3.9 L</b>			2010-2007; OE Exact Thermostat .....	◆49108	180
2003-2000; Premium Thermostat .....	◆45359	195	2006; OE Type Thermostat .....	◆14358	180
◆45358	180		<b>V-8 5.7 L; V-8 6.1 L</b>		
◆45356	160		2010-2006; OE Exact Thermostat .....	◆○48792	203
◆13009	195		<b>Dakota</b>		
◆13008	180		<b>4-Cyl. 2.5 L</b>		
◆13006	160		2002-1996; Premium Thermostat .....	◆45359	195
1999-1995; Premium Thermostat .....	◆45359	195	◆45358	180	
◆45358	180		◆45356	160	
◆45356	160		2002-1996; Economy Thermostat .....	◆13009	195
◆13359	195		◆13008	180	
◆13352	205		◆13006	160	
◆13358	180		1995; Premium Thermostat .....	◆45789	195
◆13356	160		◆45788	180	
◆13009	195		1995; OE Type Thermostat .....	◆13789	195
◆13008	180		◆13788	180	
◆13006	160		<b>V-6 3.7 L</b>		
<b>V-8 5.2 L; V-8 5.9 L</b>			2011-2004; OE Type Thermostat .....	◆○14369	195
2003-1995; Premium Thermostat .....	◆45359	195	<b>V-6 3.9 L</b>		
◆45358	180		2003; Premium Thermostat .....	◆45359	195
◆45356	160		◆45358	180	
◆13009	195		◆45356	160	
◆13008	180		◆13359	195	
◆13006	160		◆13352	205	
<b>Caravan</b>			◆13358	180	
<b>4-Cyl. 2.4 L</b>			◆13356	160	
2007; Premium Thermostat .....	◆45209	195	<b>Chrysler - Continued</b>		

◆ OE Temperature.  
○ Seal Included.

◆ Alternate Temperature.

# Thermostats for Passenger Cars and Light Trucks (1990 and Newer)

Application	Part Number	Temp°F	Application	Part Number	Temp°F
<b>Dodge - Continued</b>			<b>Dodge - Continued</b>		
<b>Dakota - Continued</b>			<b>Durango - Continued</b>		
<b>V-6 3.9 L - Continued</b>			<b>V-8 5.9 L</b>		
2003; Economy Thermostat .....	◆13009	195	2003-1998; Premium Thermostat .....	◆45359	195
	◇13008	180		◇45358	180
	◇13006	160		◇45356	160
2002-1998; Premium Thermostat .....	◆45359	195	2003-1998; Economy Thermostat .....	◆13009	195
	◇45358	180		◇13008	180
	◇45356	160		◇13006	160
2002-1998; Economy Thermostat .....	◆13009	195	<b>Grand Caravan</b>		
	◇13008	180	<b>4-Cyl. 2.4 L</b>		
	◇13006	160	1997-1996; Premium Thermostat .....	◆45209	195
1997-1995; Premium Thermostat .....	◆45359	195	1997-1996; OE Type Thermostat .....	◆14209	195
	◇45358	180	<b>V-6 3.0 L</b>		
	◇45356	160	2000-1995; Premium Thermostat .....	◆45869	195
1997-1995; OE Type Thermostat .....	◆13359	195		◇45868	180
	◇13352	205	2000-1995; OE Type Thermostat .....	◆13869	195
	◇13358	180		◇13868	180
	◇13356	160	<b>V-6 3.3 L</b>		
1997-1995; Economy Thermostat .....	◆13009	195	2010-2007; Premium Thermostat .....	◆45209	195
	◇13008	180	2010-2007; OE Type Thermostat .....	◆14209	195
	◇13006	160	2006-2001; OE Type Thermostat .....	◆14789	195
<b>V-8 4.7 L</b>			2000-1995; Premium Thermostat .....	◆45209	195
2011-2000; OE Type Thermostat .....	◆○14369	195	2000-1995; OE Type Thermostat .....	◆14209	195
<b>V-8 5.2 L</b>			<b>V-6 3.8 L</b>		
1999-1995; Premium Thermostat .....	◆45359	195	2010; OE Type Thermostat .....	◆14209	195
	◇45358	180	2009-2007; Premium Thermostat .....	◆45209	195
	◇45356	160	2009-2007; OE Type Thermostat .....	◆14209	195
1999-1995; Economy Thermostat .....	◆13009	195	2006-2001; OE Type Thermostat .....	◆14789	195
	◇13008	180	2000-1995; Premium Thermostat .....	◆45209	195
	◇13006	160	2000-1995; OE Type Thermostat .....	◆14209	195
<b>V-8 5.9 L</b>			<b>V-6 4.0 L</b>		
2003; Premium Thermostat .....	◆45359	195	2010; OE Type Thermostat .....	◆14209	195
	◇45358	180	2009-2008; Premium Thermostat .....	◆45209	195
	◇45356	160	2009-2008; OE Type Thermostat .....	◆14209	195
2003; OE Type Thermostat .....	◆13359	195	<b>Intrepid</b>		
	◇13352	205	<b>V-6 2.7 L</b>		
	◇13358	180	2004-1998; OE Type Thermostat .....	◆14349	190
	◇13356	160	<b>V-6 3.2 L</b>		
2003; Economy Thermostat .....	◆13009	195	2001-1998; OE Type Thermostat .....	◆14358	180
	◇13008	180	<b>V-6 3.3 L</b>		
	◇13006	160	1997-1995; Premium Thermostat .....	◆45209	195
2002-1998; Premium Thermostat .....	◆45359	195	1997-1995; OE Type Thermostat .....	◆14209	195
	◇45358	180	<b>V-6 3.5 L</b>		
	◇45356	160	2004-2000; OE Type Thermostat .....	◆14358	180
2002-1998; Economy Thermostat .....	◆13009	195	1997-1995; Premium Thermostat .....	◆45209	195
	◇13008	180	1997-1995; OE Type Thermostat .....	◆14209	195
	◇13006	160	<b>Journey</b>		
<b>Durango</b>			<b>V-6 3.5 L</b>		
<b>V-6 3.7 L</b>			2010-2009; Premium Thermostat .....	◆45209	195
2009-2004; OE Type Thermostat .....	◆○14369	195	2010-2009; OE Type Thermostat .....	◆14209	195
<b>V-6 3.9 L</b>			<b>Magnum</b>		
1999-1998; Premium Thermostat .....	◆45359	195	<b>V-6 2.7 L</b>		
	◇45358	180	2008-2005; OE Type Thermostat .....	◆14349	190
	◇45356	160	<b>V-6 3.5 L</b>		
1999-1998; Economy Thermostat .....	◆13009	195	2008; OE Exact Thermostat .....	◆49108	180
	◇13008	180	2008; OE Type Thermostat .....	◆○14288	180
	◇13006	160	2007; OE Exact Thermostat .....	◆49108	180
<b>V-8 4.7 L</b>			2006-2005; OE Type Thermostat .....	◆14358	180
2009-2000; OE Type Thermostat .....	◆○14369	195	<b>V-8 5.7 L</b>		
<b>V-8 5.2 L</b>			2008-2005; OE Exact Thermostat .....	◆○48792	203
2000-1998; Premium Thermostat .....	◆45359	195	<b>V-8 6.1 L</b>		
	◇45358	180	2008-2006; OE Exact Thermostat .....	◆○48792	203
	◇45356	160	<b>Neon</b>		
2000-1998; Economy Thermostat .....	◆13009	195	<b>4-Cyl. 2.0 L</b>		
	◇13008	180	2005-1995; Premium Thermostat .....	◆45209	195
	◇13006	160	2005-1995; OE Type Thermostat .....	◆14209	195
<b>V-8 5.7 L</b>			<b>Application</b>		
2009-2004; OE Exact Thermostat .....	◆○48792	203	<b>Part Number</b>		
<b>V-8 5.7 L Electric Assist</b>			<b>Temp°F</b>		
2009; OE Exact Thermostat .....	◆○48792	203			

◆ OE Temperature.  
○ Seal Included.

◇ Alternate Temperature.

## Thermostats for Passenger Cars and Light Trucks (1990 and Newer)

Application	Part Number	Temp°F	Application	Part Number	Temp°F
<b>Dodge - Continued</b>			<b>Dodge - Continued</b>		
<b>Neon - Continued</b>			<b>Ram Series Pickup - Continued</b>		
<b>4-Cyl. 2.4 L</b>			<b>V-8 5.9 L - Continued</b>		
2005-2003; Premium Thermostat .....	◆45209	195	2003; OE Type Thermostat .....	◆13359	195
2005-2003; OE Type Thermostat .....	◆14209	195	◆13352	205	
<b>Nitro</b>			◆13358	180	
<b>V-6 3.7 L</b>			◆13356	160	
2010-2007; OE Type Thermostat .....	◆○14369	195	2003; Economy Thermostat .....	◆13009	195
<b>V-6 4.0 L</b>			◆13008	180	
2010-2007; Premium Thermostat .....	◆45209	195	◆13006	160	
2010-2007; OE Type Thermostat .....	◆14209	195	2002; Premium Thermostat; Eng. VIN Z .....	◆45359	195
<b>Ram Series Pickup</b>			◆45358	180	
<b>6-Cyl. 5.9 L Diesel</b>			◆45356	160	
2009-2008; OE Type Thermostat .....	◆○14289	190	2002; Economy Thermostat; Eng. VIN Z .....	◆13009	195
2007-1999; OE Type Thermostat .....	◆○14289	190	◆13008	180	
◆○14288	180		2001-1995; Premium Thermostat .....	◆45359	195
1998; OE Type Thermostat; Eng. VIN 6 .....	◆○14289	190	◆45358	180	
◆○14288	180		◆45356	160	
1998; OE Type Thermostat; Eng. VIN D .....	◆14248	180	2001-1995; Economy Thermostat .....	◆13009	195
1997-1995; OE Type Thermostat .....	◆14248	180	◆13008	180	
<b>6-Cyl. 6.7 L Diesel</b>			◆13006	160	
2010-2007; OE Type Thermostat .....	◆○14289	190	<b>Spirit</b>		
<b>V-10 8.0 L</b>			<b>4-Cyl. 2.5 L</b>		
2003-1995; Heavy-Duty Thermostat .....	◆○14539	190	1995; Premium Thermostat .....	◆45789	195
◆○14538	180		◆45788	180	
◆○14537	170		1995; OE Type Thermostat .....	◆13789	195
◆○14536	160		◆13788	180	
<b>V-10 8.3 L</b>			<b>V-6 3.0 L</b>		
2006-2004; Heavy-Duty Thermostat .....	◆○14539	190	1995; Premium Thermostat .....	◆45869	195
◆○14538	180		◆45868	180	
◆○14537	170		1995; OE Type Thermostat .....	◆13869	195
◆○14536	160		◆13868	180	
<b>V-6 3.7 L</b>			<b>Stealth</b>		
2011-2002; OE Type Thermostat .....	◆○14369	195	<b>V-6 3.0 L</b>		
<b>V-6 3.9 L</b>			1996-1995; OE Exact Thermostat .....	◆○48217	170
2001-1998; Premium Thermostat .....	◆45359	195	1996-1995; OE Type Thermostat .....	◆14127	170
◆45358	180		◆14128	180	
◆45356	160		<b>Stratus</b>		
◆13009	195		<b>4-Cyl. 2.0 L</b>		
◆13008	180		2000-1995; Premium Thermostat .....	◆45209	195
◆13006	160		2000-1995; OE Type Thermostat .....	◆14209	195
◆45359	195		<b>4-Cyl. 2.4 L</b>		
◆45358	180		2006; Premium Thermostat .....	◆45209	195
◆45356	160		2006; OE Type Thermostat .....	◆14209	195
◆13359	195		2005-2002; OE Exact Thermostat; W/SOHC Eng. ....	◆○48239	190
◆13352	205		2005-2002; OE Type Thermostat; W/SOHC Eng. ....	◆14389	190
◆13358	180		2005-2002; Premium Thermostat; W/DOHC Eng. ....	◆45209	195
◆13356	160		2005-2002; OE Type Thermostat; W/DOHC Eng. ....	◆14209	195
◆13009	195		2001; Premium Thermostat; W/DOHC Eng. ....	◆45209	195
◆13008	180		2001; OE Type Thermostat; W/DOHC Eng. ....	◆14209	195
◆13006	160		2001; OE Exact Thermostat; W/SOHC Eng. ....	◆○48239	190
<b>V-8 4.7 L</b>			2001; OE Type Thermostat; W/SOHC Eng. ....	◆14389	190
2011-2009; OE Type Thermostat .....	◆○14369	195	2000-1995; Premium Thermostat .....	◆45209	195
2008; OE Type Thermostat .....	◆14349	190	2000-1995; OE Type Thermostat .....	◆14209	195
2007-2002; OE Type Thermostat .....	◆○14369	195	<b>V-6 2.5 L</b>		
<b>V-8 5.2 L</b>			2000-1995; OE Type Thermostat .....	◆14128	180
2001-1995; Premium Thermostat .....	◆45359	195	◆14127	170	
◆45358	180		<b>V-6 2.7 L</b>		
◆45356	160		2006-2001; OE Type Thermostat .....	◆14349	190
◆13009	195		<b>V-6 3.0 L</b>		
◆13008	180		2005-2001; OE Type Thermostat .....	◆14128	180
◆13006	160		◆14127	170	
<b>V-8 5.7 L</b>			<b>SX</b>		
2011; OE Exact Thermostat .....	◆○48792	203	<b>4-Cyl. 2.0 L (Canada)</b>		
2010; OE Type Thermostat .....	◆○14369	195	2005-2003; Premium Thermostat .....	◆45209	195
2009-2003; OE Exact Thermostat .....	◆○48792	203	2005-2003; OE Type Thermostat .....	◆14209	195
<b>V-8 5.9 L</b>			<b>4-Cyl. 2.4 L (Canada)</b>		
2003; Premium Thermostat .....	◆45359	195	2005; Premium Thermostat .....	◆45209	195
◆45358	180		2005; OE Type Thermostat .....	◆14209	195
◆45356	160				

◆ OE Temperature.  
 ◆ Alternate Temperature.

○ Seal Included.



## Thermostats for Passenger Cars and Light Trucks (1990 and Newer)

Application	Part Number	Temp°F	Application	Part Number	Temp°F
<b>Dodge - Continued</b>			<b>Ford - Continued</b>		
<b>Viper</b>			<b>Aerostar - Continued</b>		
V-10 8.0 L			V-6 4.0 L		
1995; Heavy-Duty Thermostat .....	◆○14538	180	1997-1995; Premium Thermostat .....	◆45369	195
	◇○14539	190		◇45368	180
	◇○14537	170	1997-1995; OE Type Thermostat .....	◆13959	195
	◇○14536	160		◇13958	180
V-10 8.3 L			<b>Aspire</b>		
2006-2003; Heavy-Duty Thermostat .....	◆○14539	190	4-Cyl. 1.3 L		
	◇○14538	180	1997-1995; Premium Thermostat .....	◆45869	195
	◇○14537	170		◇45868	180
	◇○14536	160	1997-1995; OE Type Thermostat .....	◆13869	195
V-10 8.4 L				◇13868	180
2009-2008; Heavy-Duty Thermostat .....	◆○14539	190	<b>Bronco</b>		
	◇○14538	180	V-8 5.0 L; V-8 5.8 L		
	◇○14537	170	1996-1995; Premium Thermostat .....	◆45359	195
	◇○14536	160		◇45358	180
<b>Eagle</b>				◇45356	160
<b>Summit</b>			1996-1995; Economy Thermostat .....	◆13009	195
4-Cyl. 1.5 L				◇13008	180
1996-1995; Premium Thermostat .....	◆45869	195		◇13006	160
	◇45868	180	<b>Contour</b>		
1996-1995; OE Type Thermostat .....	◆13869	195	4-Cyl. 2.0 L		
	◇13868	180	2000-1995; Premium Thermostat .....	◆45979	195
4-Cyl. 1.8 L; 4-Cyl. 2.4 L				◇45978	180
1996-1995; OE Exact Thermostat .....	◆○48168	180	2000-1995; OE Type Thermostat .....	◆13979	195
1996-1995; OE Type Thermostat .....	◆14078	180		◇13978	180
	◇14077	170	V-6 2.5 L		
<b>Talon</b>			2000-1997; OE Type Thermostat .....	◆14139	188
4-Cyl. 2.0 L				◇14138	180
1998-1997; OE Exact Thermostat; Eng. VIN F .....	◆○48168	180	1996-1995; OE Type Thermostat .....	◆14138	180
1998-1997; OE Type Thermostat; Eng. VIN F .....	◆14078	180		◇14139	188
	◇14077	170	<b>Crown Victoria</b>		
1998-1997; Premium Thermostat; Eng. VIN Y .....	◆45209	195	V-8 4.6 L		
1998-1997; OE Type Thermostat; Eng. VIN Y .....	◆14209	195	2011-2010; OE Type Thermostat .....	◆13779	195
1996-1995; OE Type Thermostat; Eng. VIN F .....	◆14078	180		◆45779	195
	◇14077	170	2009-1996; Premium Thermostat .....	◇45778	180
1996-1995; Premium Thermostat; Eng. VIN Y .....	◆45209	195		◆13779	195
1996-1995; OE Type Thermostat; Eng. VIN Y .....	◆14209	195	2009-1996; OE Type Thermostat .....	◇13778	180
<b>Vision</b>			1995; Premium Thermostat .....	◆45399	195
V-6 3.3 L				◇45398	180
1996-1995; Premium Thermostat .....	◆45209	195	1995; OE Type Thermostat .....	◆13399	195
1996-1995; OE Type Thermostat .....	◆14209	195		◇13398	180
V-6 3.3 L (Canada)			<b>E Series Van</b>		
1997; Premium Thermostat .....	◆45209	195	6-Cyl. 4.9 L		
1997; OE Type Thermostat .....	◆14209	195	1996-1995; Premium Thermostat .....	◆45359	195
V-6 3.5 L				◇45358	180
1997-1995; Premium Thermostat .....	◆45209	195		◇45356	160
1997-1995; OE Type Thermostat .....	◆14209	195	1996-1995; OE Type Thermostat .....	◆13359	195
<b>Ford</b>				◇13352	205
<b>Aerostar</b>				◇13358	180
V-6 3.0 L				◇13356	160
1997-1996; Premium Thermostat .....	◆45359	195	1996-1995; Economy Thermostat .....	◆13009	195
	◇45358	180		◇13008	180
	◇45356	160		◇13006	160
1997-1996; Economy Thermostat .....	◆13009	195	V-10 6.8 L		
	◇13008	180	2011; Premium Thermostat .....	◆45779	195
	◇13006	160		◆13779	195
1995; Premium Thermostat .....	◆45359	195		◆13779	195
	◇45358	180		◇13778	180
	◇45356	160	V-6 4.2 L		
1995; OE Type Thermostat .....	◆13359	195	2003-1998; OE Type Thermostat .....	◆14989	192
	◇13352	205		◆13779	195
	◇13358	180		◇13778	180
	◇13356	160	V-8 4.6 L		
1995; Economy Thermostat .....	◆13009	195	2011-2010; Premium Thermostat .....	◆45779	195
	◇13008	180		◆13779	195
	◇13006	160		◆45779	195
				◇45778	180

◆ OE Temperature.  
◇ Alternate Temperature.

○ Seal Included.

## Thermostats for Passenger Cars and Light Trucks (1990 and Newer)

Application	Part Number	Temp°F	Application	Part Number	Temp°F
<b>Ford - Continued</b>			<b>Ford - Continued</b>		
<b>E Series Van - Continued</b>			<b>Escape - Continued</b>		
<b>V-8 4.6 L - Continued</b>			<b>4-Cyl. 2.5 L Electric Assist</b>		
2009-1999; OE Type Thermostat .....	◆13779	195	2010-2009; OE Exact Thermostat Water Outlet Assembly .....	◆○48708	180
1998-1997; OE Type Thermostat .....	◆13778	180			
	◆13779	195			
	◆13778	180			
<b>V-8 5.0 L</b>			<b>V-6 3.0 L</b>		
1996-1995; Premium Thermostat .....	◆45359	195	2011; OE Type Thermostat .....	◆14139	188
	◆45358	180	2010-2009; Premium Thermostat .....	◆45779	195
	◆45356	160	2010-2009; OE Type Thermostat .....	◆14139	188
1996-1995; Economy Thermostat .....	◆13009	195	2008; OE Type Thermostat .....	◆14138	180
	◆13008	180		◆14139	188
	◆13006	160		◆14139	188
				◆14138	180
<b>V-8 5.4 L</b>			<b>Escort</b>		
2011; Premium Thermostat .....	◆45779	195	<b>4-Cyl. 1.8 L</b>		
2011; OE Type Thermostat .....	◆13779	195	1996-1995; Premium Thermostat .....	◆45869	195
2010; OE Type Thermostat .....	◆13779	195		◆45868	180
	◆13778	180	1996-1995; OE Type Thermostat .....	◆13869	195
2009-1999; Premium Thermostat .....	◆45779	195		◆13868	180
	◆45778	180			
2009-1999; OE Type Thermostat .....	◆13779	195	<b>4-Cyl. 1.9 L</b>		
	◆13778	180	1996-1995; Premium Thermostat .....	◆○45829	195
1998-1997; Premium Thermostat .....	◆45779	195		◆○45828	180
1998-1997; OE Type Thermostat .....	◆13779	195		◆○45820	192
	◆13778	180	1996-1995; OE Type Thermostat .....	◆○13829	195
				◆○13828	180
				◆○13820	192
<b>V-8 5.8 L</b>			<b>4-Cyl. 2.0 L</b>		
1996-1995; Premium Thermostat .....	◆45359	195	2002-1998; Premium Thermostat; W/DOHC Eng. ....	◆45979	195
	◆45358	180		◆45978	180
	◆45356	160	2002-1998; OE Type Thermostat; W/DOHC Eng. ....	◆13979	195
1996-1995; Economy Thermostat .....	◆13009	195		◆13978	180
	◆13008	180	2002-1998; Premium Thermostat; W/SOHC Eng. ....	◆○45990	192
	◆13006	160	2002-1998; OE Type Thermostat; W/SOHC Eng. ....	◆○14990	192
			1997; Premium Thermostat .....	◆○45990	192
<b>V-8 7.3 L Diesel</b>				◆○14990	192
1998-1996; OE Type Thermostat .....	◆14269	195	<b>Excursion</b>		
1995; OE Type Thermostat .....	◆14252	205	<b>V-10 6.8 L</b>		
			2005-2000; Premium Thermostat .....	◆45779	195
<b>V-8 7.5 L</b>				◆45778	180
1996-1995; Premium Thermostat .....	◆45359	195	2005-2000; OE Type Thermostat .....	◆13779	195
	◆45358	180		◆13778	180
	◆45356	160			
1996-1995; Economy Thermostat .....	◆13009	195	<b>V-8 5.4 L</b>		
	◆13008	180	2005-2000; Premium Thermostat .....	◆45779	195
	◆13006	160		◆45778	180
			2005-2000; OE Type Thermostat .....	◆13779	195
				◆13778	180
<b>Edge</b>			<b>V-8 6.0 L Diesel</b>		
<b>V-6 3.5 L</b>			2005-2003; Heavy-Duty Thermostat .....	◆○14899	192
2011-2010; OE Type Thermostat .....	◆14138	180	<b>V-8 7.3 L Diesel</b>		
2009-2007; OE Type Thermostat .....	◆14138	180	2003-2000; OE Type Thermostat .....	◆14269	195
	◆14139	188			
<b>V-6 3.7 L</b>			<b>Expedition</b>		
2011; OE Type Thermostat .....	◆14138	180	<b>V-8 4.6 L</b>		
			2004-1997; Premium Thermostat .....	◆45779	195
				◆45778	180
			2004-1997; OE Type Thermostat .....	◆13779	195
				◆13778	180
<b>Escape</b>			<b>V-8 5.4 L</b>		
<b>4-Cyl. 2.0 L</b>			2011-2010; Premium Thermostat .....	◆45779	195
2004-2001; Premium Thermostat .....	◆45979	195	2011-2010; OE Type Thermostat .....	◆13779	195
	◆45978	180	2009-1997; Premium Thermostat .....	◆45779	195
2004-2001; OE Type Thermostat .....	◆13979	195		◆45778	180
	◆13978	180	2009-1997; OE Type Thermostat .....	◆13779	195
				◆13778	180
<b>4-Cyl. 2.3 L</b>			<b>Explorer</b>		
2008; OE Exact Thermostat Water Outlet Assembly .....	◆○48708	180	<b>V-6 3.5 L</b>		
2007; OE Exact Thermostat Water Outlet Assembly; Jan. 1 & Newer .....	◆○48689	194	2011; OE Type Thermostat .....	◆14138	180
2007; OE Exact Thermostat Water Outlet Assembly; Dec. 31, 2006 & Older .....	◆○48708	180	<b>V-6 4.0 L</b>		
2006-2005; OE Exact Thermostat Water Outlet Assembly .....	◆○48689	194	2010-2001; OE Type Thermostat .....	◆13649	190
				◆13648	180
<b>4-Cyl. 2.3 L Electric Assist</b>					
2008-2005; OE Exact Thermostat Water Outlet Assembly .....	◆○48708	180			
<b>4-Cyl. 2.5 L</b>					
2011-2009; OE Exact Thermostat Water Outlet Assembly .....	◆○48708	180			

◆ OE Temperature.  
○ Seal Included.

◆ Alternate Temperature.

## Thermostats for Passenger Cars and Light Trucks (1990 and Newer)

Application	Part Number	Temp°F	Application	Part Number	Temp°F
<b>Ford - Continued</b>			<b>Ford - Continued</b>		
<b>Explorer - Continued</b>			<b>F Series Pickup - Continued</b>		
<b>V-6 4.0 L - Continued</b>			<b>V-8 4.6 L - Continued</b>		
2000-1997; Premium Thermostat; W/O.H.V. Eng. ....	◆45369	195	2005-1997; Premium Thermostat .....	◆45779	195
	◇45368	180		◇45778	180
2000-1997; OE Type Thermostat; W/O.H.V. Eng. ....	◆13959	195	2005-1997; OE Type Thermostat .....	◆13779	195
	◇13958	180		◇13778	180
2000-1997; OE Type Thermostat; W/SOHC Eng. ....	◆13649	190	<b>V-8 5.0 L</b>		
	◇13648	180	1996-1995; Premium Thermostat .....	◆45359	195
1996-1995; Premium Thermostat .....	◆45369	195		◇45358	180
	◇45368	180		◇45356	160
1996-1995; OE Type Thermostat .....	◆13959	195	1996-1995; Economy Thermostat .....	◆13009	195
	◇13958	180		◇13008	180
				◇13006	160
<b>V-8 4.6 L</b>			<b>V-8 5.4 L</b>		
2010-2005; Premium Thermostat .....	◆45779	195	2010; Premium Thermostat .....	◆45779	195
	◇45778	180	2010; OE Type Thermostat .....	◆13779	195
2010-2005; OE Type Thermostat .....	◆13779	195		◇13778	180
	◇13778	180	2009; Premium Thermostat .....	◆45779	195
2004-2002; OE Type Thermostat .....	◆13779	195		◇45778	180
	◇13778	180	2009; OE Type Thermostat .....	◆13779	195
<b>V-8 5.0 L</b>				◇13778	180
2001-1996; Premium Thermostat .....	◆45359	195	2008-2007; Premium Thermostat .....	◆45779	195
	◇45358	180	2008-2007; OE Type Thermostat .....	◆13779	195
	◇45356	160		◇13778	180
2001-1996; Economy Thermostat .....	◆13009	195	2006-1997; Premium Thermostat .....	◆45779	195
	◇13008	180		◇45778	180
	◇13006	160	2006-1997; OE Type Thermostat .....	◆13779	195
				◇13778	180
<b>Explorer Sport Trac</b>			<b>V-8 5.8 L</b>		
<b>V-6 4.0 L</b>			1997-1995; Premium Thermostat .....	◆45359	195
2010; OE Type Thermostat .....	◆13649	190		◇45358	180
2009-2007; OE Type Thermostat .....	◆13649	190		◇45356	160
	◇13648	180	1997-1995; Economy Thermostat .....	◆13009	195
2005-2001; OE Type Thermostat .....	◆13649	190		◇13008	180
	◇13648	180		◇13006	160
<b>V-8 4.6 L</b>			<b>V-8 7.3 L Diesel</b>		
2010; Premium Thermostat .....	◆45779	195	1997-1996; OE Type Thermostat .....	◆14269	195
2010; OE Type Thermostat .....	◆13779	195	1995; OE Type Thermostat .....	◆14252	205
2009; Premium Thermostat .....	◆45779	195			
	◇45778	180	<b>V-8 7.5 L</b>		
2009; OE Type Thermostat .....	◆13779	195	1997-1995; Premium Thermostat .....	◆45359	195
	◇13778	180		◇45358	180
2008-2007; Premium Thermostat .....	◆45779	195		◇45356	160
2008-2007; OE Type Thermostat .....	◆13779	195	1997-1995; Economy Thermostat .....	◆13009	195
	◇13778	180		◇13008	180
				◇13006	160
<b>F Series Pickup</b>			<b>Five Hundred</b>		
<b>6-Cyl. 4.9 L</b>			<b>V-6 3.0 L</b>		
1996-1995; Premium Thermostat .....	◆45359	195	2007-2005; OE Type Thermostat .....	◆14138	180
	◇45358	180		◇14139	188
	◇45356	160	<b>Flex</b>		
1996-1995; OE Type Thermostat .....	◆13359	195	<b>V-6 3.5 L</b>		
	◇13352	205	2011-2009; OE Type Thermostat .....	◆14138	180
	◇13358	180	<b>Focus</b>		
	◇13356	160	<b>4-Cyl. 2.0 L</b>		
1996-1995; Economy Thermostat .....	◆13009	195	2011-2005; OE Exact Thermostat Water Outlet		
	◇13008	180	Assembly; W/Sensor .....	◆○48672	208
	◇13006	160	2011-2005; OE Exact Thermostat Water Outlet		
<b>V-6 4.2 L</b>			Assembly; W/O Sensor .....	◆○48708	180
2008-1999; OE Type Thermostat .....	◆14989	192	2004; Premium Thermostat; W/SOHC Eng. ....	◆○45990	192
1998-1997; OE Type Thermostat .....	◆13779	195	2004; OE Type Thermostat; W/SOHC Eng. ....	◆○14990	192
	◇13778	180		◆45979	195
<b>V-8 4.6 L</b>				◇45978	180
2010; Premium Thermostat .....	◆45779	195	2004; OE Type Thermostat; W/DOHC Eng. ....	◆13979	195
2010; OE Type Thermostat .....	◆13779	195		◇13978	180
2009; Premium Thermostat .....	◆45779	195	2003; Premium Thermostat; Eng. VIN 3, 5 .....	◆45979	195
	◇45778	180		◇45978	180
	◆13779	195	2003; OE Type Thermostat; Eng. VIN 3, 5 .....	◆13979	195
	◇13778	180		◇13978	180
2008-2007; Premium Thermostat .....	◆45779	195	2003; Premium Thermostat; Eng. VIN P .....	◆○45990	192
2008-2007; OE Type Thermostat .....	◆13779	195	2003; OE Type Thermostat; Eng. VIN P .....	◆○14990	192
	◇13778	180	2002; Premium Thermostat; Eng. VIN P .....	◆○45990	192
2006; Premium Thermostat .....	◆45779	195			
2006; OE Type Thermostat .....	◆13779	195			

◆ OE Temperature.  
○ Seal Included.

◇ Alternate Temperature.

# Thermostats for Passenger Cars and Light Trucks (1990 and Newer)

Application	Part Number	Temp°F	Application	Part Number	Temp°F
<b>Ford - Continued</b>			<b>Ford - Continued</b>		
<b>Focus - Continued</b>			<b>Mustang - Continued</b>		
<b>4-Cyl. 2.0 L - Continued</b>			<b>V-6 3.8 L - Continued</b>		
2002; OE Type Thermostat; Eng. VIN P .....	◆○14990	192	2003; Premium Thermostat .....	◆45359	195
2002; Premium Thermostat; Eng. VIN 3 .....	◆45979	195	◆45358	180	
	◆45978	180	◆45356	160	
2002; OE Type Thermostat; Eng. VIN 3 .....	◆13979	195	2003; OE Type Thermostat .....	◆13359	195
	◆13978	180	◆13352	205	
2001; Premium Thermostat; W/DOHC Eng. ....	◆45979	195	◆13358	180	
	◆45978	180	◆13356	160	
2001; OE Type Thermostat; W/DOHC Eng. ....	◆13979	195	2003; Economy Thermostat .....	◆13009	195
	◆13978	180	◆13008	180	
2001; Premium Thermostat; W/SOHC Eng. ....	◆○45990	192	◆13006	160	
2001; OE Type Thermostat; W/SOHC Eng. ....	◆○14990	192	2002-1999; Premium Thermostat .....	◆45359	195
2000; Premium Thermostat; Eng. VIN 3 .....	◆45979	195	◆45358	180	
	◆45978	180	◆45356	160	
2000; OE Type Thermostat; Eng. VIN 3 .....	◆13979	195	2002-1999; OE Type Thermostat .....	◆13859	195
	◆13978	180	◆13858	180	
2000; Premium Thermostat; Eng. VIN P .....	◆○45990	192	2002-1999; Economy Thermostat .....	◆13009	195
2000; OE Type Thermostat; Eng. VIN P .....	◆○14990	192	◆13008	180	
			◆13006	160	
<b>4-Cyl. 2.3 L</b>			<b>V-6 3.9 L</b>		
2007-2003; OE Exact Thermostat Water Outlet Assembly .....	◆○48708	180	2004; Premium Thermostat .....	◆45359	195
			◆45358	180	
			◆45356	160	
			◆13009	195	
			◆13008	180	
			◆13006	160	
<b>Freestar</b>			<b>V-6 3.9 L</b>		
<b>V-6 3.9 L; V-6 4.2 L</b>			<b>2004; Premium Thermostat</b>		
2007-2004; Premium Thermostat .....	◆45359	195	◆45358	180	
	◆45356	160	◆45356	160	
2007-2004; Economy Thermostat .....	◆13009	195	◆13859	195	
	◆13008	180	◆13858	180	
	◆13006	160	◆13009	195	
			◆13008	180	
			◆13006	160	
<b>Freestyle</b>			<b>V-6 4.0 L</b>		
<b>V-6 3.0 L</b>			<b>2010; OE Type Thermostat</b>		
2007-2005; OE Type Thermostat .....	◆14138	180	◆13649	190	
	◆14139	188	◆13649	190	
			◆13648	180	
<b>Fusion</b>			<b>V-8 4.6 L</b>		
<b>4-Cyl. 2.3 L</b>			<b>2010; Premium Thermostat</b>		
2009-2006; OE Exact Thermostat Water Outlet Assembly .....	◆○48708	180	◆45779	195	
			◆13779	195	
<b>4-Cyl. 2.5 L; 4-Cyl. 2.5 L Electric Assist</b>			<b>2010; OE Type Thermostat</b>		
2010; OE Exact Thermostat Water Outlet Assembly .....	◆○48708	180	◆45779	195	
			◆45778	180	
<b>V-6 3.0 L</b>			<b>2009-2007; Premium Thermostat</b>		
2011; OE Type Thermostat .....	◆14139	188	◆45779	195	
2010; Premium Thermostat .....	◆45779	195	◆45778	180	
2010; OE Type Thermostat .....	◆14139	188	◆13779	195	
2009; OE Type Thermostat .....	◆14138	180	◆13778	180	
	◆14139	188	◆14138	180	
2008-2007; OE Type Thermostat .....	◆14139	188	◆14139	188	
2006; OE Type Thermostat .....	◆14139	188	◆14138	180	
	◆14138	180	2004-2003; OE Type Thermostat; W/DOHC Eng. ....	◆14138	180
			2004-2003; Premium Thermostat; W/SOHC Eng. ....	◆45779	195
			◆45778	180	
			◆13779	195	
			◆13778	180	
<b>V-6 3.5 L</b>			<b>2002; Premium Thermostat</b>		
2011-2010; OE Type Thermostat .....	◆14138	180	◆45399	195	
			◆45398	180	
<b>GT</b>			<b>2002; OE Type Thermostat</b>		
<b>V-8 5.4 L</b>			<b>2002; OE Type Thermostat</b>		
2006; Heavy-Duty Thermostat .....	◆○14538	180	◆13399	195	
	◆○14539	190	◆13398	180	
	◆○14537	170	◆14089	188	
	◆○14536	160	◆45399	195	
			◆45398	180	
<b>Mustang</b>			<b>2001; OE Type Thermostat; Eng. VIN X</b>		
<b>V-6 3.8 L</b>			<b>2001; Premium Thermostat; Eng. VIN X</b>		
2004; Premium Thermostat .....	◆45359	195	◆13399	195	
	◆45358	180	◆13398	180	
	◆45356	160	◆45399	195	
2004; OE Type Thermostat .....	◆13859	195	◆45398	180	
	◆13858	180	◆13399	195	
2004; Economy Thermostat .....	◆13009	195	◆13398	180	
	◆13008	180	◆45399	195	
	◆13006	160	◆13399	195	
			◆13398	180	
			◆13398	180	
			1999-1996; OE Type Thermostat; Eng. VIN V .....	◆14089	188
			1999-1996; Premium Thermostat; Eng. VIN X .....	◆45399	195
			◆45398	180	
			◆13399	195	
			◆13398	180	
			1999-1996; OE Type Thermostat; Eng. VIN X .....	◆13399	195
			◆13398	180	

◆ OE Temperature.  
 ◆ Alternate Temperature.

○ Seal Included.

## Thermostats for Passenger Cars and Light Trucks (1990 and Newer)

Application	Part Number	Temp°F	Application	Part Number	Temp°F
<b>Ford - Continued</b>			<b>Ford - Continued</b>		
<b>Mustang - Continued</b>			<b>Super Duty Pickup - Continued</b>		
V-8 5.0 L			V-8 6.0 L Diesel		
1995; Premium Thermostat .....	◆45359	195	2007-2003; Heavy-Duty Thermostat .....	◆○14899	192
	◆45358	180	V-8 6.4 L Diesel		
	◆45356	160	2010-2008; OE Exact Thermostat Kit .....	◆○49200	192/203
1995; Economy Thermostat .....	◆13009	195	V-8 7.3 L Diesel		
	◆13008	180	2003-1999; OE Type Thermostat .....	◆14269	195
	◆13006	160	1997-1996; OE Type Thermostat .....	◆14269	195
			1995; OE Type Thermostat .....	◆14252	205
<b>Probe</b>			V-8 7.5 L		
4-Cyl. 2.0 L; V-6 2.5 L			1997-1995; Premium Thermostat .....	◆45359	195
1997-1995; OE Type Thermostat .....	◆14048	180		◆45358	180
	◆14047	170		◆45356	160
<b>Ranger</b>				◆13009	195
4-Cyl. 2.3 L				◆13008	180
2011-2004; OE Exact Thermostat Water Outlet				◆13006	160
Assembly .....	◆○48708	180	1997-1995; Economy Thermostat .....		
2003-2001; OE Exact Thermostat Water Outlet					
Assembly .....	◆○48672	208	<b>Super Duty Van</b>		
1997-1995; Premium Thermostat .....	◆○45829	195	V-10 6.8 L		
	◆○45828	180	2011; Premium Thermostat .....	◆45779	195
	◆○45820	192	2011; OE Type Thermostat .....	◆13779	195
1997-1995; OE Type Thermostat .....	◆○13829	195	2010-2000; Premium Thermostat .....	◆45779	195
	◆○13828	180		◆45778	180
	◆○13820	192	2010-2000; OE Type Thermostat .....	◆13779	195
4-Cyl. 2.5 L				◆13778	180
2001-1998; Premium Thermostat .....	◆○45990	192	1999; OE Type Thermostat .....	◆13779	195
2001-1998; OE Type Thermostat .....	◆○14990	192		◆13778	180
V-6 3.0 L			1998-1997; Premium Thermostat .....	◆45779	195
2008-1999; Premium Thermostat .....	◆45359	195		◆45778	180
	◆45358	180	1998-1997; OE Type Thermostat .....	◆13779	195
	◆45356	160		◆13778	180
2008-1999; OE Type Thermostat .....	◆13859	195	V-6 4.2 L		
	◆13858	180	2003-2001; Premium Thermostat .....	◆45779	195
2008-1999; Economy Thermostat .....	◆13009	195		◆45778	180
	◆13008	180	2003-2001; OE Type Thermostat .....	◆13779	195
	◆13006	160		◆13778	180
1998-1996; Premium Thermostat .....	◆45359	195	V-8 4.6 L		
	◆45358	180	2009-2008; Premium Thermostat .....	◆45779	195
	◆45356	160		◆45778	180
1998-1996; Economy Thermostat .....	◆13009	195	2009-2008; OE Type Thermostat .....	◆13779	195
	◆13008	180		◆13778	180
	◆13006	160	2006; Premium Thermostat .....	◆45779	195
1995; Premium Thermostat .....	◆45359	195		◆45778	180
	◆45358	180	2006; OE Type Thermostat .....	◆13779	195
	◆45356	160		◆13778	180
1995; OE Type Thermostat .....	◆13359	195	2003; Premium Thermostat .....	◆45779	195
	◆13352	205		◆45778	180
	◆13358	180	2003; OE Type Thermostat .....	◆13779	195
	◆13356	160		◆13778	180
1995; Economy Thermostat .....	◆13009	195	V-8 5.4 L		
	◆13008	180	2011; Premium Thermostat .....	◆45779	195
	◆13006	160	2011; OE Type Thermostat .....	◆13779	195
V-6 4.0 L			2010-1999; Premium Thermostat .....	◆45779	195
2011-2010; OE Type Thermostat .....	◆13649	190		◆45778	180
2009-2001; OE Type Thermostat .....	◆13649	190	2010-1999; OE Type Thermostat .....	◆13779	195
	◆13648	180		◆13778	180
2000-1995; Premium Thermostat .....	◆45369	195	1998-1997; Premium Thermostat .....	◆45779	195
	◆45368	180	1998-1997; OE Type Thermostat .....	◆13779	195
2000-1995; OE Type Thermostat .....	◆13959	195		◆13778	180
	◆13958	180	V-8 6.0 L Diesel		
<b>Super Duty Pickup</b>			2010-2008; Heavy-Duty Thermostat .....	◆○14899	192
V-10 6.8 L			2010-2008; Premium Thermostat .....	◆45778	180
2010-1999; Premium Thermostat .....	◆45779	195	2010-2008; OE Type Thermostat .....	◆13778	180
	◆45778	180	2007-2004; Heavy-Duty Thermostat .....	◆○14899	192
2010-1999; OE Type Thermostat .....	◆13779	195	V-8 7.3 L Diesel		
	◆13778	180	2003-1996; OE Type Thermostat .....	◆14269	195
V-8 5.4 L			<b>Taurus</b>		
2010-1999; Premium Thermostat .....	◆45779	195	V-6 3.0 L		
	◆45778	180	2007-2006; Premium Thermostat .....	◆45359	195
2010-1999; OE Type Thermostat .....	◆13779	195		◆45358	180
	◆13778	180		◆45356	160

◆ OE Temperature.  
○ Seal Included.

◆ Alternate Temperature.

# Thermostats for Passenger Cars and Light Trucks (1990 and Newer)

Application	Part Number	Temp°F	Application	Part Number	Temp°F
<b>Ford - Continued</b>			<b>Ford - Continued</b>		
<b>Taurus - Continued</b>			<b>Thunderbird - Continued</b>		
<b>V-6 3.0 L - Continued</b>			<b>V-6 3.8 L - Continued</b>		
2007-2006; Economy Thermostat .....	◆13009	195	1996-1995; Economy Thermostat .....	◆13009	195
	◇13008	180		◇13008	180
	◇13006	160		◇13006	160
2005-2003; Premium Thermostat; Eng. VIN 2, U .....	◆45359	195	<b>V-8 3.9 L</b>		
	◇45358	180	2003-2002; OE Type Thermostat .....	◆○14748	183
	◇45356	160	<b>V-8 4.6 L</b>		
2005-2003; Economy Thermostat; Eng. VIN 2, U .....	◆13009	195	1997-1995; Premium Thermostat .....	◆45399	195
	◇13008	180		◇45398	180
	◇13006	160	1997-1995; OE Type Thermostat .....	◆13399	195
2005-2003; OE Type Thermostat; Eng. VIN S .....	◆14139	188		◇13398	180
	◇14138	180	<b>Transit Connect</b>		
2002-2000; OE Type Thermostat; W/DOHC Eng. ....	◆14139	188	<b>4-Cyl. 2.0 L</b>		
	◇14138	180	2011-2010; OE Exact Thermostat Water Outlet		
2002-2000; Premium Thermostat; W/O.H.V. Eng. ....	◆45359	195	Assembly .....	◆○48689	194
	◇45358	180	<b>Windstar</b>		
	◇45356	160	<b>V-6 3.0 L</b>		
2002-2000; Economy Thermostat; W/O.H.V. Eng. ....	◆13009	195	2000; Premium Thermostat .....		
	◇13008	180		◆45359	195
	◇13006	160		◇45358	180
1999-1996; OE Type Thermostat; W/DOHC Eng. ....	◆14138	180		◇45356	160
	◇14139	188	2000; Economy Thermostat .....	◆13009	195
1999-1996; Premium Thermostat; W/O.H.V. Eng. ....	◆45359	195		◇13008	180
	◇45358	180		◇13006	160
	◇45356	160	1999; Premium Thermostat .....	◆45359	195
1999-1996; Economy Thermostat; W/O.H.V. Eng. ....	◆13009	195		◇45358	180
	◇13008	180		◇45356	160
	◇13006	160	1999; OE Type Thermostat .....	◆13859	195
1995; Premium Thermostat; Eng. VIN U .....	◆45359	195		◇13858	180
	◇45358	180	1999; Economy Thermostat .....	◆13009	195
	◇45356	160		◇13008	180
1995; Economy Thermostat; Eng. VIN U .....	◆13009	195		◇13006	160
	◇13008	180	1998-1995; Premium Thermostat .....	◆45359	195
	◇13006	160		◇45358	180
1995; Premium Thermostat; Eng. VIN Y .....	◆45979	195		◇45356	160
	◇45978	180	1998-1995; Economy Thermostat .....	◆13009	195
1995; OE Type Thermostat; Eng. VIN Y .....	◆13979	195		◇13008	180
	◇13978	180		◇13006	160
<b>V-6 3.2 L</b>			<b>V-6 3.8 L</b>		
1995; Premium Thermostat .....	◆45979	195	2003-2000; Premium Thermostat .....		
	◇45978	180		◆45359	195
1995; OE Type Thermostat .....	◆13979	195		◇45358	180
	◇13978	180		◇45356	160
<b>V-6 3.5 L</b>			2003-2000; Economy Thermostat .....	◆13009	195
2011-2009; OE Type Thermostat .....	◆14138	180		◇13008	180
2008; OE Type Thermostat .....	◆14138	180		◇13006	160
	◇14139	188	1999-1996; Premium Thermostat .....	◆45779	195
<b>V-6 3.8 L</b>				◇45778	180
1995; Premium Thermostat .....	◆45359	195	1999-1996; OE Type Thermostat .....	◆13779	195
	◇45358	180		◇13778	180
	◇45356	160	1995; Premium Thermostat .....	◆45359	195
1995; Economy Thermostat .....	◆13009	195		◇45358	180
	◇13008	180		◇45356	160
	◇13006	160	1995; Economy Thermostat .....	◆13009	195
<b>V-8 3.4 L</b>				◇13008	180
1999-1996; OE Type Thermostat .....	◆14078	180		◇13006	160
	◇14077	170	<b>Geo</b>		
<b>Thunderbird</b>			<b>Metro</b>		
<b>V-6 3.8 L</b>			<b>3-Cyl. 1.0 L</b>		
1997; Premium Thermostat .....	◆45359	195	1997; Premium Thermostat .....		
	◇45358	180		◆45849	195
	◇45356	160		◇45848	180
1997; OE Type Thermostat .....	◆13859	195	1997; OE Type Thermostat .....	◆13849	195
	◇13858	180		◇13848	180
1997; Economy Thermostat .....	◆13009	195	1996-1995; Premium Thermostat .....	◆45848	180
	◇13008	180		◇45849	195
	◇13006	160	1996-1995; OE Type Thermostat .....	◆13848	180
1996-1995; Premium Thermostat .....	◆45359	195		◇13849	195
	◇45358	180	<b>4-Cyl. 1.3 L</b>		
	◇45356	160	1997-1995; Premium Thermostat .....		
				◆45849	195
				◇45848	180

◆ OE Temperature.  
○ Seal Included.

◇ Alternate Temperature.

## Thermostats for Passenger Cars and Light Trucks (1990 and Newer)

Application	Part Number	Temp°F	Application	Part Number	Temp°F
<b>Geo - Continued</b>			<b>GMC - Continued</b>		
<b>Metro - Continued</b>			<b>C &amp; K Series Pickup - Continued</b>		
<b>4-Cyl. 1.3 L - Continued</b>			<b>V-8 8.1 L</b>		
1997-1995; OE Type Thermostat .....	◆13849	195	2002-2001; Premium Thermostat .....	◆○45899	195
	◇13848	180	2002-2001; OE Type Thermostat .....	◆○13899	195
<b>Prizm</b>			<b>Canyon</b>		
<b>4-Cyl. 1.6 L; 4-Cyl. 1.8 L</b>			<b>4-Cyl. 2.8 L</b>		
1997-1995; Premium Thermostat .....	◆45758	180	2006-2004; OE Exact Thermostat Water Outlet Assembly .....	◆○48718	180
1997-1995; OE Type Thermostat .....	◆13758	180	<b>4-Cyl. 2.9 L</b>		
<b>Tracker</b>			<b>2010-2007; OE Exact Thermostat Water Outlet Assembly .....</b>		
<b>4-Cyl. 1.6 L</b>			<b>◆○48718 180</b>		
1997-1995; OE Type Thermostat .....	◇13959	195	<b>5-Cyl. 3.5 L</b>		
	◆13958	180	<b>2006-2004; OE Exact Thermostat Water Outlet Assembly .....</b>		
<b>GMC</b>			<b>◆○48718 180</b>		
<b>C &amp; K Series Pickup</b>			<b>5-Cyl. 3.7 L</b>		
<b>V-6 4.3 L</b>			<b>2010-2007; OE Exact Thermostat Water Outlet Assembly .....</b>		
1998-1996; Premium Thermostat .....	◆○45119	195	<b>◆○48718 180</b>		
1998-1996; OE Type Thermostat .....	◆○14119	195	<b>Envoy</b>		
1995; Premium Thermostat .....	◆45359	195	<b>6-Cyl. 4.2 L</b>		
	◇45358	180	<b>2009-2002; Thermostat Water Outlet Assembly .....</b>		
	◇45356	160	<b>◆○14659 190</b>		
1995; OE Type Thermostat .....	◆13359	195	<b>V-8 5.3 L</b>		
	◇13352	205	<b>2006-2004; Heavy-Duty Thermostat .....</b>		
	◇13358	180	<b>2003; Thermostat Water Outlet Assembly; W/OE or Most Aftermarket Water Pumps .....</b>		
	◇13356	160	<b>◆○14298 186</b>		
1995; Economy Thermostat .....	◆13009	195	<b>2003; Heavy-Duty Thermostat; W/GM Replacement Water Pump .....</b>		
	◇13008	180	<b>◆○14948 186</b>		
	◇13006	160	<b>G Series Van</b>		
<b>V-8 5.0 L</b>			<b>V-6 4.3 L</b>		
1999-1996; Premium Thermostat .....	◆○45119	195	<b>1996-1995; Premium Thermostat .....</b>		
1999-1996; OE Type Thermostat .....	◆○14119	195	<b>◆45359 195</b>		
1995; Premium Thermostat .....	◆45359	195	<b>◇45358 180</b>		
	◇45358	180	<b>◇45356 160</b>		
	◇45356	160	<b>1996-1995; OE Type Thermostat .....</b>		
1995; OE Type Thermostat .....	◆13359	195	<b>◆13359 195</b>		
	◇13352	205	<b>◇13352 205</b>		
	◇13358	180	<b>◇13358 180</b>		
	◇13356	160	<b>◇13356 160</b>		
1995; Economy Thermostat .....	◆13009	195	<b>1996-1995; Economy Thermostat .....</b>		
	◇13008	180	<b>◆13009 195</b>		
	◇13006	160	<b>◇13008 180</b>		
<b>V-8 5.7 L</b>			<b>◇13006 160</b>		
<b>2000-1996; Premium Thermostat .....</b>			<b>V-8 5.0 L</b>		
<b>◆○45119 195</b>			<b>1995; Premium Thermostat .....</b>		
<b>◆○14119 195</b>			<b>◆45359 195</b>		
<b>1995; Premium Thermostat .....</b>			<b>◇45358 180</b>		
<b>◆45359 195</b>			<b>◇45356 160</b>		
<b>◇45358 180</b>			<b>1995; OE Type Thermostat .....</b>		
<b>◇45356 160</b>			<b>◆13359 195</b>		
<b>1995; OE Type Thermostat .....</b>			<b>◇13352 205</b>		
<b>◆13359 195</b>			<b>◇13358 180</b>		
<b>◇13352 205</b>			<b>◇13356 160</b>		
<b>◇13358 180</b>			<b>1995; Economy Thermostat .....</b>		
<b>◇13356 160</b>			<b>◆13009 195</b>		
<b>1995; Economy Thermostat .....</b>			<b>◇13008 180</b>		
<b>◆13009 195</b>			<b>◇13006 160</b>		
<b>◇13008 180</b>			<b>V-8 5.7 L</b>		
<b>◇13006 160</b>			<b>1996-1995; Premium Thermostat .....</b>		
<b>V-8 6.5 L Diesel</b>			<b>◆45359 195</b>		
<b>2002-2001; OE Type Thermostat .....</b>			<b>◇45358 180</b>		
<b>②◆○14399 190</b>			<b>◇45356 160</b>		
<b>2000; OE Type Thermostat; 2nd Design .....</b>			<b>◆13359 195</b>		
<b>◆○14399 190</b>			<b>◇13352 205</b>		
<b>2000; OE Type Thermostat; 1st Design .....</b>			<b>◆13358 180</b>		
<b>◆14039 195</b>			<b>◇13356 160</b>		
<b>1999-1997; Premium Thermostat .....</b>			<b>1996-1995; Economy Thermostat .....</b>		
<b>②◆45359 195</b>			<b>◆13009 195</b>		
<b>1999-1997; OE Type Thermostat .....</b>			<b>◇13008 180</b>		
<b>②◆13359 195</b>			<b>◇13006 160</b>		
<b>1996; OE Type Thermostat; 2nd Design .....</b>			<b>V-8 6.5 L Diesel</b>		
<b>◆○14399 190</b>			<b>1996-1995; OE Type Thermostat .....</b>		
<b>1996; OE Type Thermostat; 1st Design .....</b>			<b>◆14429 190</b>		
<b>◆14039 195</b>			<b>V-8 7.4 L</b>		
<b>1995; OE Type Thermostat .....</b>			<b>2000-1996; Premium Thermostat .....</b>		
<b>◆14039 195</b>			<b>◆○45899 195</b>		
<b>V-8 7.4 L</b>			<b>2000-1996; OE Type Thermostat .....</b>		
<b>2000-1996; Premium Thermostat .....</b>			<b>◆○13899 195</b>		
<b>◆○45899 195</b>			<b>1995; Premium Thermostat .....</b>		
<b>◆45849 195</b>			<b>◆45849 195</b>		
<b>◇45848 180</b>			<b>◇45848 180</b>		
<b>1995; OE Type Thermostat .....</b>			<b>◆13849 195</b>		
<b>◆13849 195</b>			<b>◇13848 180</b>		
<b>◇13848 180</b>			<b>V-8 7.4 L</b>		
<b>1996-1995; OE Type Thermostat .....</b>			<b>1996-1995; Premium Thermostat .....</b>		
<b>◆13849 195</b>			<b>◆45849 195</b>		
<b>◇13848 180</b>			<b>◇45848 180</b>		
<b>◆13849 195</b>			<b>◆13849 195</b>		
<b>◇13848 180</b>			<b>◇13848 180</b>		

◆ OE Temperature.  
○ Seal Included.

◇ Alternate Temperature.  
② Two Required.





## Thermostats for Passenger Cars and Light Trucks (1990 and Newer)

Application	Part Number	Temp°F	Application	Part Number	Temp°F
<b>GMC - Continued</b>			<b>GMC - Continued</b>		
<b>Sierra Series Pickup - Continued</b>			<b>Yukon - Continued</b>		
<b>V-8 6.6 L Diesel - Continued</b>			<b>V-8 5.3 L - Continued</b>		
2009-2001; OE Type Thermostat - Rear .....	◆○14738	180	2006-2000; Heavy-Duty Thermostat; W/GM Replacement Water Pump .....	◆○14948	186
<b>V-8 8.1 L</b>			<b>V-8 5.7 L</b>		
2007-2001; Premium Thermostat .....	◆○45899	195	2000-1996; Premium Thermostat .....	◆○45119	195
2007-2001; OE Type Thermostat .....	◆○13899	195	2000-1996; OE Type Thermostat .....	◆○14119	195
<b>Sonoma</b>			1995; Premium Thermostat .....		
<b>4-Cyl. 2.2 L</b>			1995; Premium Thermostat .....		
2003-1995; Premium Thermostat .....	◆45849	195	◆45359	195	
	◆45848	180	◆45358	180	
2003-1995; OE Type Thermostat .....	◆13849	195	◆45356	160	
	◆13848	180	◆45356	160	
<b>V-6 4.3 L</b>			1995; OE Type Thermostat .....		
2004-1996; Premium Thermostat .....	◆○45119	195			
2004-1996; OE Type Thermostat .....	◆○14119	195	<b>V-8 6.0 L</b>		
1995; Premium Thermostat; Eng. VIN W .....	◆45849	195	2006-2004; Heavy-Duty Thermostat .....		
	◆45848	180	2003-2000; Thermostat Water Outlet Assembly; W/OE or Most Aftermarket Water Pumps .....		
1995; OE Type Thermostat; Eng. VIN W .....	◆13849	195	2003-2000; Heavy-Duty Thermostat; W/GM Replacement Water Pump .....		
	◆13848	180	◆○14948 186		
1995; Premium Thermostat; Eng. VIN Z .....	◆45359	195	◆○14298 186		
	◆45358	180	◆○14948 186		
	◆45356	160	<b>V-8 6.5 L Diesel</b>		
1995; OE Type Thermostat; Eng. VIN Z .....	◆13359	195	1997; Premium Thermostat .....		
	◆13352	205	◆45359 195		
	◆13358	180	1997; OE Type Thermostat .....		
	◆13356	160	◆13359 195		
1995; Economy Thermostat; Eng. VIN Z .....	◆13009	195	◆14039 195		
	◆13008	180	<b>V-8 8.1 L</b>		
	◆13006	160	2006-2001; Premium Thermostat .....		
<b>Suburban</b>			2006-2001; OE Type Thermostat .....		
<b>V-8 5.7 L</b>			◆○45899 195		
1999-1996; Premium Thermostat .....	◆○45119	195	◆○13899 195		
1999-1996; OE Type Thermostat .....	◆○14119	195	<b>Honda</b>		
1995; Premium Thermostat .....	◆45359	195	<b>Accord</b>		
	◆45358	180	<b>4-Cyl. 2.2 L</b>		
	◆45356	160	1997-1995; OE Exact Thermostat .....		
1995; OE Type Thermostat .....	◆13359	195	◆48158 180		
	◆13352	205	◆45878 180		
	◆13358	180	◆45879 195		
	◆13356	160	◆45877 170		
1995; Economy Thermostat .....	◆13009	195	1997-1995; OE Type Thermostat .....		
	◆13008	180	◆13878 180		
	◆13006	160	◆13879 195		
<b>V-8 6.5 L Diesel</b>			<b>4-Cyl. 2.3 L</b>		
1999-1997; OE Type Thermostat .....	②◆○14399	190	2002-1998; Premium Thermostat .....		
1996; OE Type Thermostat; 2nd Design .....	◆○14399	190	◆45877 170		
1996; OE Type Thermostat; 1st Design .....	◆14039	195	◆45878 180		
1995; OE Type Thermostat .....	◆14039	195	<b>4-Cyl. 2.4 L</b>		
<b>V-8 7.4 L</b>			2011; OE Exact Thermostat Water Outlet Assembly .....		
1999-1996; Premium Thermostat .....	◆○45899	195	2009-2003; OE Exact Thermostat Water Outlet Assembly .....		
1999-1996; OE Type Thermostat .....	◆○13899	195	◆○48767 172		
1995; Premium Thermostat .....	◆45849	195	◆○48767 172		
	◆45848	180	<b>V-6 2.7 L</b>		
1995; OE Type Thermostat .....	◆13849	195	1997-1995; OE Exact Thermostat .....		
	◆13848	180	◆48227 170		
<b>Terrain</b>			1997-1995; OE Type Thermostat .....		
<b>4-Cyl. 2.4 L</b>			◆14127 170		
2011-2010; OE Exact Thermostat .....	◆○48628	180	◆14128 180		
2011-2010; OE Type Thermostat .....	◆○14698	180	<b>V-6 3.0 L</b>		
<b>Yukon</b>			2007-2003; OE Exact Thermostat .....		
<b>V-8 4.8 L</b>			2007-2003; OE Type Thermostat .....		
2006-2004; Heavy-Duty Thermostat .....	◆○14948	186	2002; OE Exact Thermostat -Door; 2-Door .....		
2003-2000; Thermostat Water Outlet Assembly; W/OE or Most Aftermarket Water Pumps .....	◆○14298	186	◆48227 170		
2003-2000; Heavy-Duty Thermostat; W/GM Replacement Water Pump .....	◆○14948	186	◆○14337 170		
<b>V-8 5.3 L</b>			2002; OE Type Thermostat -Door; 2-Door .....		
2006-2000; Thermostat Water Outlet Assembly; W/OE or Most Aftermarket Water Pumps .....	◆○14298	186	◆○48487 170		
			◆○14337 170		
			◆○48487 170		
			2002; OE Exact Thermostat -Door; 4-Door .....		
			◆○14337 170		
			2001-2000; OE Exact Thermostat .....		
			◆○48487 170		
			2001-2000; OE Type Thermostat .....		
			◆○14337 170		
			1999-1998; OE Exact Thermostat .....		
			◆○48487 170		
			◆14127 170		
			◆14128 180		
			<b>V-6 3.0 L Electric Assist</b>		
			2007-2005; OE Exact Thermostat .....		
			◆48227 170		
			2007-2005; OE Type Thermostat .....		
			◆○14337 170		
			<b>V-6 3.5 L</b>		
			2011-2008; OE Exact Thermostat .....		
			◆48227 170		
			2011-2008; OE Type Thermostat .....		
			◆○14337 170		

◆ OE Temperature.  
 ◆ Alternate Temperature.

○ Seal Included.  
 ② Two Required.

## Thermostats for Passenger Cars and Light Trucks (1990 and Newer)

Application	Part Number	Temp°F	Application	Part Number	Temp°F
<b>Honda - Continued</b>			<b>Honda - Continued</b>		
<b>Civic</b>			<b>Element</b>		
4-Cyl. 1.3 L Electric Assist			4-Cyl. 2.4 L		
2011; Premium Thermostat .....	◆45879	195	2011-2003; OE Exact Thermostat Water Outlet Assembly .....	◆○48767	172
2011; OE Type Thermostat .....	◆13879	195			
2009-2003; Premium Thermostat .....	◆45878	180			
	◇45879	195			
	◇45877	170			
2009-2003; OE Type Thermostat .....	◆13878	180			
	◇13879	195			
4-Cyl. 1.5 L			<b>Fit</b>		
1995; Premium Thermostat .....	◆45877	170	4-Cyl. 1.5 L		
	◇45878	180	2011; Premium Thermostat .....	◆45879	195
4-Cyl. 1.6 L			2011; OE Type Thermostat .....	◆13879	195
2000-1999; Premium Thermostat .....	◆45877	170	2010-2009; Premium Thermostat .....	◆45877	170
	◇45878	180		◇45879	195
1998-1996; OE Exact Thermostat .....	◆48158	180		◇45878	180
1998-1996; Premium Thermostat .....	◆45878	180	2010-2009; OE Type Thermostat .....	◇13878	180
	◇45879	195	2008-2007; Premium Thermostat .....	◆45877	170
	◇45877	170		◇45879	195
1998-1996; OE Type Thermostat .....	◆13878	180		◇45878	180
	◇13879	195			
1995; Premium Thermostat .....	◆45877	170			
	◇45878	180			
4-Cyl. 1.7 L			<b>Insight</b>		
2005; Premium Thermostat .....	◆45877	170	3-Cyl. 1.0 L Electric Assist		
	◇45879	195	2006-2000; Premium Thermostat .....	◆45879	195
	◇45878	180		◇45878	180
2004-2001; Premium Thermostat .....	◆45877	170		◇45877	170
	◇45878	180	2006-2000; OE Type Thermostat .....	◆13879	195
				◇13878	180
4-Cyl. 1.8 L			4-Cyl. 1.3 L Electric Assist		
2011-2010; OE Type Thermostat .....	◆13879	195	2011; Premium Thermostat .....	◆45879	195
2011-2010; Premium Thermostat .....	◆45879	195	2011; OE Type Thermostat .....	◆13879	195
2009; Premium Thermostat .....	◆45878	180	2010; Premium Thermostat .....	◆45877	170
	◇45879	195	2010; OE Exact Thermostat Water Outlet Assembly .....	◆○48767	172
	◇45877	170			
2009; OE Type Thermostat .....	◆13878	180			
2008-2006; Premium Thermostat .....	◆45877	170			
	◇45879	195			
	◇45878	180			
4-Cyl. 2.0 L			<b>Odyssey</b>		
2011-2006; OE Exact Thermostat Water Outlet Assembly .....	◆○48747	172	4-Cyl. 2.2 L		
2005-2003; Thermostat Water Outlet Assembly .....	◆○14757	172	1997-1996; OE Exact Thermostat .....	◆48158	180
2002; OE Type Thermostat .....	◆○14337	170	1997-1996; Premium Thermostat .....	◆45878	180
				◇45879	195
				◇45877	170
			1997-1996; OE Type Thermostat .....	◆13878	180
				◇13879	195
			1995; Premium Thermostat .....	◆45878	180
				◇45879	195
				◇45877	170
			1995; OE Type Thermostat .....	◆13878	180
				◇13879	195
<b>Civic Del Sol</b>			4-Cyl. 2.3 L		
4-Cyl. 1.5 L			1998; OE Exact Thermostat .....	◆48158	180
1995; Premium Thermostat .....	◆45878	180	1998; Premium Thermostat .....	◆45878	180
	◇45879	195		◇45879	195
	◇45877	170		◇45877	170
1995; OE Type Thermostat .....	◆13878	180	1998; OE Type Thermostat .....	◆13878	180
	◇13879	195		◇13879	195
4-Cyl. 1.6 L			V-6 3.5 L		
1997-1995; Premium Thermostat .....	◆45878	180	2011-2002; OE Exact Thermostat .....	◆48227	170
	◇45879	195	2011-2002; OE Type Thermostat .....	◆○14337	170
	◇45877	170	2001-1999; OE Exact Thermostat .....	◆○48487	170
1997-1995; OE Type Thermostat .....	◆13878	180	2001-1999; OE Type Thermostat .....	◆○14337	170
	◇13879	195			
<b>CR-V</b>			<b>Passport</b>		
4-Cyl. 2.0 L			4-Cyl. 2.6 L		
2001-1997; Premium Thermostat .....	◆45877	170	1996-1995; Premium Thermostat .....	◆45858	180
	◇45878	180		◇45859	195
4-Cyl. 2.4 L			1996-1995; OE Type Thermostat .....	◆13858	180
2011-2007; OE Exact Thermostat Water Outlet Assembly .....	◆○48747	172		◇13859	195
2006-2002; Thermostat Water Outlet Assembly .....	◆○14757	172			
			V-6 3.2 L		
			2002-1998; OE Type Thermostat .....	◆○14327	170
			1997-1995; OE Type Thermostat .....	◆14177	170
				◇14178	180
<b>CR-Z</b>			<b>Pilot</b>		
4-Cyl. 1.5 L Electric Assist			V-6 3.5 L		
2011; Premium Thermostat .....	◆45879	195	2011-2003; OE Exact Thermostat .....	◆48227	170
2011; OE Type Thermostat .....	◆13879	195	2011-2003; OE Type Thermostat .....	◆○14337	170

◆ OE Temperature.  
○ Seal Included.

◇ Alternate Temperature.

# Thermostats for Passenger Cars and Light Trucks (1990 and Newer)

Application	Part Number	Temp°F	Application	Part Number	Temp°F
<b>Honda - Continued</b>			<b>Hyundai</b>		
<b>Prelude</b>			<b>Accent</b>		
<b>4-Cyl. 2.2 L</b>			<b>4-Cyl. 1.5 L</b>		
2001-1997: OE Exact Thermostat .....	◆48227	170	2002-2000: Premium Thermostat .....	◆45359	195
2001-1997: OE Type Thermostat .....	◆14127	170	2002-2000: OE Type Thermostat .....	◆13359	195
	◇14128	180	1999-1998: OE Exact Thermostat .....	◆48469	190
1996: OE Exact Thermostat; W/VTEC Eng. ....	◆48227	170	1999-1998: OE Type Thermostat .....	◆13979	195
1996: OE Type Thermostat; W/VTEC Eng. ....	◆14127	170	1997-1995: OE Exact Thermostat .....	◆48469	190
	◇14128	180	<b>4-Cyl. 1.6 L</b>		
1996: Premium Thermostat; W/O VTEC Eng. ....	◆45878	180	2010-2001: OE Exact Thermostat .....	◆48588	180
	◇45879	195	2010-2001: OE Type Thermostat .....	◆14648	180
	◇45877	170	<b>Elantra</b>		
1996: OE Type Thermostat; W/O VTEC Eng. ....	◆13878	180	<b>4-Cyl. 1.6 L</b>		
	◇13879	195	1995: Premium Thermostat .....	◆45869	195
1995: OE Type Thermostat; W/VTEC Eng. ....	◆14127	170		◇45868	180
	◇14128	180	1995: OE Type Thermostat .....	◆13869	195
1995: Premium Thermostat; W/O VTEC Eng. ....	◆45878	180		◇13868	180
	◇45879	195	<b>4-Cyl. 1.8 L</b>		
	◇45877	170	1998-1996: OE Exact Thermostat .....	◆48588	180
1995: OE Type Thermostat; W/O VTEC Eng. ....	◆13878	180	1998-1996: OE Type Thermostat .....	◆14648	180
	◇13879	195	1995: Premium Thermostat .....	◆45869	195
<b>4-Cyl. 2.3 L</b>				◇45868	180
1996: Premium Thermostat .....	◆45878	180	1995: OE Type Thermostat .....	◆13869	195
	◇45879	195		◇13868	180
	◇45877	170	<b>4-Cyl. 2.0 L</b>		
1996: OE Type Thermostat .....	◆13878	180	2010-1999: OE Exact Thermostat .....	◆48588	180
	◇13879	195	2010-1999: OE Type Thermostat .....	◆14648	180
1995: OE Exact Thermostat .....	◆48158	180	<b>Genesis</b>		
1995: Premium Thermostat .....	◆45878	180	<b>4-Cyl. 2.0 L</b>		
	◇45879	195	2010: OE Type Thermostat .....	◆14648	180
	◇45877	170	<b>Santa Fe</b>		
1995: OE Type Thermostat .....	◆13878	180	<b>4-Cyl. 2.4 L</b>		
	◇13879	195	2004-2001: OE Exact Thermostat .....	◆○48268	180
<b>Ridgeline</b>			2004-2001: OE Type Thermostat .....	◆○14808	180
<b>V-6 3.5 L</b>			<b>V-6 2.7 L</b>		
2011-2006: OE Exact Thermostat .....	◆48227	170	2009-2006: OE Type Thermostat .....	◆14128	180
2011-2006: OE Type Thermostat .....	◆○14337	170	2005-2001: OE Type Thermostat .....	◆14128	180
<b>S2000</b>				◇14127	170
<b>4-Cyl. 2.0 L</b>			<b>V-6 3.3 L</b>		
2003-2002: OE Exact Thermostat .....	◆48227	170	2009-2007: OE Type Thermostat .....	◆14128	180
2003-2002: OE Type Thermostat .....	◆○14337	170	<b>V-6 3.5 L</b>		
2001-2000: OE Exact Thermostat .....	◆48227	170	2006-2003: OE Type Thermostat .....	◆14128	180
2001-2000: OE Type Thermostat .....	◆14127	170		◇14127	170
	◇14128	180	<b>Scoupe</b>		
<b>4-Cyl. 2.2 L</b>			<b>4-Cyl. 1.5 L</b>		
2009-2004: OE Exact Thermostat .....	◆48227	170	1995: OE Exact Thermostat .....	◆48469	190
2009-2004: OE Type Thermostat .....	◆○14337	170	<b>Sonata</b>		
<b>Hummer</b>			<b>4-Cyl. 2.0 L</b>		
<b>H1</b>			1998-1995: Premium Thermostat .....	◆45869	195
<b>V-8 6.5 L Diesel</b>				◇45868	180
2004-2002: OE Type Thermostat .....	◆○14399	190	1998-1995: OE Type Thermostat .....	◆13869	195
<b>H2</b>				◇13868	180
<b>V-8 6.0 L</b>			<b>4-Cyl. 2.4 L</b>		
2007-2003: Thermostat Water Outlet Assembly; W/OE or Most Aftermarket Water Pumps .....	◆○14298	186	2011: OE Type Thermostat .....	◆14648	180
2007-2003: Heavy-Duty Thermostat; W/GM Replacement Water Pump .....	◆○14948	186	2011: OE Exact Thermostat .....	◆48588	180
<b>H3</b>			2010-2009: OE Exact Thermostat .....	◆48588	180
<b>5-Cyl. 3.5 L</b>			2010-2009: OE Type Thermostat .....	◆14648	180
2006: OE Exact Thermostat Water Outlet Assembly .....	◆○48718	180	2008-2006: OE Type Thermostat .....	◆14648	180
<b>5-Cyl. 3.7 L</b>			2005-1999: OE Exact Thermostat .....	◆○48268	180
2009-2007: OE Exact Thermostat Water Outlet Assembly .....	◆○48718	180	2005-1999: OE Type Thermostat .....	◆○14808	180
<b>H3T</b>			<b>V-6 2.5 L</b>		
<b>5-Cyl. 3.7 L; V-8 5.3 L</b>			2001-1999: OE Type Thermostat .....	◆14128	180
2009: OE Exact Thermostat Water Outlet Assembly .....	◆○48718	180		◇14127	170
			<b>V-6 2.7 L</b>		
			2005-2004: OE Type Thermostat .....	◆14128	180
				◇14127	170
			2003: OE Type Thermostat .....	◆14128	180

◆ OE Temperature.  
○ Seal Included.

◇ Alternate Temperature.

## Thermostats for Passenger Cars and Light Trucks (1990 and Newer)

Application	Part Number	Temp°F	Application	Part Number	Temp°F
<b>Hyundai - Continued</b>			<b>Infiniti - Continued</b>		
<b>Sonata - Continued</b>			<b>G35</b>		
V-6 2.7 L - Continued			V-6 3.5 L		
2002; OE Type Thermostat .....	◆14128	180	2007-2003; Thermostat Water Outlet Assembly .....	◆14668	180
	◇14127	170			
V-6 3.0 L			<b>G37</b>		
1998-1995; Premium Thermostat .....	◆45869	195	V-6 3.7 L		
	◇45868	180	2010-2008; Thermostat Water Outlet Assembly .....	◆14318	180
1998-1995; OE Type Thermostat .....	◆13869	195			
	◇13868	180	<b>I30</b>		
<b>Tiburon</b>			V-6 3.0 L		
4-Cyl. 1.8 L			2001-1996; Thermostat Water Outlet Assembly .....	◆14318	180
1998-1997; OE Exact Thermostat .....	◆48588	180			
1998-1997; OE Type Thermostat .....	◆14648	180	<b>I35</b>		
4-Cyl. 2.0 L			V-6 3.5 L		
2008-2003; OE Exact Thermostat .....	◆48588	180	2004-2002; Thermostat Water Outlet Assembly .....	◆14778	180
2008-2003; OE Type Thermostat .....	◆14648	180			
2001-1997; OE Exact Thermostat .....	◆48588	180	<b>J30</b>		
2001-1997; OE Type Thermostat .....	◆14648	180	V-6 3.0 L		
V-6 2.7 L			1997-1995; OE Exact Thermostat .....	◆48197	170
2008-2003; OE Type Thermostat .....	◆14128	180	1997-1995; Premium Thermostat .....	◆45947	170
	◇14127	170		◆45948	180
			1997-1995; OE Type Thermostat .....	◆13947	170
				◇13948	180
<b>Tucson</b>			<b>M35</b>		
4-Cyl. 2.0 L			V-6 3.5 L		
2009-2005; OE Exact Thermostat .....	◆48588	180	2008-2006; Thermostat Water Outlet Assembly .....	◆14668	180
2009-2005; OE Type Thermostat .....	◆14648	180			
V-6 2.7 L			<b>M45</b>		
2009-2005; OE Type Thermostat .....	◆14128	180	V-8 4.5 L		
	◇14127	170	2010-2008; OE Type Thermostat - Lower .....	◆14128	180
			2010-2008; OE Type Thermostat - Upper .....	◆15112	205
<b>XG300</b>			2007; OE Type Thermostat - Lower .....	◆14128	180
V-6 3.0 L				◇14127	170
2001; OE Type Thermostat .....	◆14128	180	2007; OE Type Thermostat - Upper .....	◆15112	205
	◇14127	170	2006; OE Type Thermostat - Lower .....	◆14128	180
			2006; OE Type Thermostat - Upper .....	◆15112	205
<b>XG350</b>			2004-2003; OE Type Thermostat - Lower .....	◆14128	180
V-6 3.5 L				◇14127	170
2005-2002; OE Type Thermostat .....	◆14128	180	2004-2003; OE Type Thermostat - Upper .....	◆15112	205
	◇14127	170			
<b>Infiniti</b>			<b>Q45</b>		
<b>FX35</b>			V-8 4.5 L		
V-6 3.5 L			2006; OE Type Thermostat - Lower .....	◆14128	180
2008-2003; Thermostat Water Outlet Assembly .....	◆14668	180	2006; OE Type Thermostat - Upper .....	◆15112	205
			2005-2003; OE Type Thermostat - Lower .....	◆14128	180
				◇14127	170
<b>FX45</b>			2005-2003; OE Type Thermostat - Upper .....	◆15112	205
V-8 4.5 L			2002; Thermostat Water Outlet Assembly .....	◆14668	180
2008; OE Type Thermostat - Lower .....	◆14128	180	2002; OE Type Thermostat - Lower .....	◆14128	180
	◇14127	170	2002; OE Type Thermostat - Upper .....	◆15112	205
2008; OE Type Thermostat - Upper .....	◆15112	205	1996-1995; OE Type Thermostat .....	◆14687	170
2007-2006; OE Type Thermostat - Lower .....	◆14128	180			
2007-2006; OE Type Thermostat - Upper .....	◆15112	205	<b>QX4</b>		
2005-2003; OE Type Thermostat - Lower .....	◆14128	180	V-6 3.3 L		
	◇14127	170	2000-1997; OE Exact Thermostat .....	◆48138	180
2005-2003; OE Type Thermostat - Upper .....	◆15112	205	2000-1997; Premium Thermostat .....	◆45948	180
				◇45947	170
			2000-1997; OE Type Thermostat .....	◆13948	180
				◇13947	170
<b>FX50</b>			V-6 3.5 L		
V-8 5.0 L			2003-2001; Thermostat Water Outlet Assembly .....	◆14668	180
2009; OE Type Thermostat .....	◆14128	180			
	◇14127	170	<b>QX56</b>		
<b>G20</b>			V-8 5.6 L		
4-Cyl. 2.0 L			2009-2007; OE Type Thermostat .....	◆14128	180
2002-1999; OE Exact Thermostat .....	◆48258	180		◇14127	170
2002-1999; OE Type Thermostat .....	◆14818	180	2005-2004; OE Type Thermostat .....	◆14128	180
1996-1995; OE Exact Thermostat .....	◆48447	170		◇14127	170
1996-1995; Premium Thermostat .....	◆45967	170	<b>ISUZU</b>		
1996-1995; OE Type Thermostat .....	◆13967	170	<b>Amigo</b>		
	◇13968	180	V-6 3.2 L		
			2000-1998; OE Exact Thermostat .....	◆48247	170

◆ OE Temperature.  
○ Seal Included.

◇ Alternate Temperature.  
✚ Gasket Not Required. Use Silicone.

## Thermostats for Passenger Cars and Light Trucks (1990 and Newer)

Application	Part Number	Temp°F	Application	Part Number	Temp°F
<b>Isuzu - Continued</b>			<b>Isuzu - Continued</b>		
<b>Amigo - Continued</b>			<b>Trooper</b>		
V-6 3.2 L - Continued			V-6 3.2 L		
2000-1998; OE Type Thermostat .....	◆○14327	170	1997-1995; OE Type Thermostat .....	◆14177	170
				◆14178	180
<b>Ascender</b>			V-6 3.5 L		
6-Cyl. 4.2 L			2002-1998; OE Exact Thermostat .....		
2007-2003; Thermostat Water Outlet Assembly .....	◆○14659	190	2002-1998; OE Type Thermostat .....	◆○14327	170
V-8 5.3 L			2002-1998; OE Type Thermostat .....		
2006-2004; Heavy-Duty Thermostat .....	◆○14948	186			
2003; Thermostat Water Outlet Assembly; W/OE or Most			<b>Vehicross</b>		
Aftermarket Water Pumps .....	◆○14298	186	V-6 3.5 L		
2003; Heavy-Duty Thermostat; W/GM Replacement			2001-1999; OE Exact Thermostat .....		
Water Pump .....	◆○14948	186	2001-1999; OE Type Thermostat .....	◆○14327	170
<b>Axiom</b>			<b>Jaguar</b>		
V-6 3.5 L			<b>S-Type</b>		
2004; Premium Thermostat .....			V-6 3.0 L		
	◆45879	195	2007; OE Exact Thermostat Water Outlet Assembly .....		
	◆45878	180	2006-2000; OE Type Thermostat .....	◆○48788	180
	◆45877	170		◆14139	188
2004; OE Type Thermostat .....	◆13879	195		◆14138	180
	◆13878	180	V-8 4.0 L		
2003-2002; OE Exact Thermostat .....	◆○48247	170	2002-2000; OE Type Thermostat .....		
2003-2002; OE Type Thermostat .....	◆○14327	170		◆○14748	183
<b>Hombre</b>			V-8 4.2 L		
4-Cyl. 2.2 L			2007-2003; OE Type Thermostat .....		
2000-1996; Premium Thermostat .....				◆○14748	183
	◆45849	195	<b>Super V8</b>		
	◆45848	180	V-8 4.2 L		
	◆13849	195	2006-2005; OE Type Thermostat .....		
	◆13848	180		◆○14748	183
V-6 4.3 L			<b>Vanden Plas</b>		
2000-1997; Premium Thermostat .....			6-Cyl. 4.0 L		
2000-1997; OE Type Thermostat .....	◆○45119	195	1997-1995; OE Type Thermostat .....		
	◆○14119	195		◆13649	190
				◆13648	180
<b>I-280</b>			V-8 4.0 L		
4-Cyl. 2.8 L			2003-2000; OE Type Thermostat .....		
2006; OE Exact Thermostat Water Outlet Assembly .....	◆○48718	180		◆○14748	183
<b>I-290</b>			<b>X-Type</b>		
4-Cyl. 2.9 L			V-6 2.5 L		
2008-2007; OE Exact Thermostat Water Outlet			2005-2002; OE Exact Thermostat Water Outlet		
Assembly .....	◆○48718	180	Assembly .....	◆○48788	180
<b>I-350</b>			V-6 3.0 L		
5-Cyl. 3.5 L			2006-2002; OE Exact Thermostat Water Outlet		
2006; OE Exact Thermostat Water Outlet Assembly .....	◆○48718	180	Assembly .....	◆○48788	180
<b>I-370</b>			<b>XJ6</b>		
5-Cyl. 3.7 L			6-Cyl. 4.0 L		
2008-2007; OE Exact Thermostat Water Outlet			1997-1995; OE Type Thermostat .....		
Assembly .....	◆○48718	180		◆13649	190
				◆13648	180
<b>Oasis</b>			<b>XJ8</b>		
4-Cyl. 2.2 L			V-8 4.0 L		
1997-1996; Premium Thermostat .....			2003-2000; OE Type Thermostat .....		
	◆45878	180		◆○14748	183
1997-1996; OE Type Thermostat .....	◆13878	180	<b>XJ12</b>		
<b>Pickup</b>			V-12 6.0 L		
4-Cyl. 2.3 L; 4-Cyl. 2.6 L			1996; Premium Thermostat .....		
1995; Premium Thermostat .....	◆45858	180		◆45378	180
	◆45859	195		◆45379	195
1995; OE Type Thermostat .....	◆13858	180	1996; OE Type Thermostat .....	◆13378	180
	◆13859	195		◆13379	195
				◆13376	160
			1995; Premium Thermostat .....	◆45398	180
				◆45399	195
			1995; OE Type Thermostat .....	◆13398	180
				◆13399	195
<b>Rodeo</b>			<b>XJR</b>		
4-Cyl. 2.6 L			6-Cyl. 4.0 L		
1997-1995; Premium Thermostat .....			1997-1995; OE Type Thermostat .....		
	◆45858	180		◆13649	190
	◆45859	195		◆13648	180
1997-1995; OE Type Thermostat .....	◆13858	180	V-8 4.0 L		
	◆13859	195	2003-2000; OE Type Thermostat .....		
				◆○14748	183
V-6 3.2 L			V-8 4.2 L		
2004-1998; OE Exact Thermostat .....			2008-2004; OE Type Thermostat .....		
2004-1998; OE Type Thermostat .....	◆○48247	170		◆○14748	183
	◆○14327	170			
1997-1995; OE Type Thermostat .....	◆14177	170			
	◆14178	180			

◆ OE Temperature.  
 ◆ Alternate Temperature.

○ Seal Included.

## Thermostats for Passenger Cars and Light Trucks (1990 and Newer)

Application	Part Number	Temp°F	Application	Part Number	Temp°F
<b>Jaguar - Continued</b>			<b>Jeep - Continued</b>		
<b>XJS</b>			<b>Grand Cherokee - Continued</b>		
6-Cyl. 4.0 L			V-8 5.9 L		
1996-1995; OE Type Thermostat .....	◆13649	190	1998; Premium Thermostat .....	◆45359	195
	◇13648	180		◇45358	180
V-12 6.0 L				◇45356	160
1995; Premium Thermostat .....	◆45398	180	1998; Economy Thermostat .....	◆13009	195
	◇45399	195		◇13008	180
1995; OE Type Thermostat .....	◆13398	180		◇13006	160
	◇13399	195	V-8 6.1 L		
<b>XK8</b>			2010-2006; OE Exact Thermostat .....	◆○48792	203
V-8 4.0 L			<b>Liberty</b>		
2002-2000; OE Type Thermostat .....	◆○14748	183	4-Cyl. 2.4 L		
<b>XKR</b>			2005-2002; Premium Thermostat .....	◆45209	195
V-8 4.0 L			2005-2002; OE Type Thermostat .....	◆14209	195
2002-2000; OE Type Thermostat .....	◆○14748	183	V-6 3.7 L		
V-8 4.2 L			2010-2002; OE Type Thermostat .....	◆○14369	195
2006-2004; OE Type Thermostat .....	◆○14748	183	<b>TJ</b>		
<b>Jeep</b>			4-Cyl. 2.4 L (Canada)		
<b>Cherokee</b>			2006-2003; Premium Thermostat .....	◆45209	195
4-Cyl. 2.5 L			2006-2003; OE Type Thermostat .....	◆14209	195
2000-1995; Premium Thermostat .....	◆45359	195	4-Cyl. 2.5 L (Canada)		
	◇45358	180	2002-1997; Premium Thermostat .....	◆45359	195
	◇45356	160		◇45358	180
2000-1995; Economy Thermostat .....	◆13009	195		◇45356	160
	◇13008	180	2002-1997; Economy Thermostat .....	◆13009	195
	◇13006	160		◇13008	180
6-Cyl. 4.0 L				◇13006	160
2001-1995; Premium Thermostat .....	◆45359	195	6-Cyl. 4.0 L (Canada)		
	◇45358	180	2006; Premium Thermostat .....	◆45359	195
	◇45356	160		◇45358	180
2001-1995; Economy Thermostat .....	◆13009	195		◇45356	160
	◇13008	180	2006; Economy Thermostat .....	◆13009	195
	◇13006	160		◇13008	180
<b>Commander</b>				◇13006	160
V-6 3.7 L			2005-2003; Premium Thermostat .....	◆45359	195
2010-2006; OE Type Thermostat .....	◆○14369	195		◇45358	180
V-8 4.7 L				◇45356	160
2009-2006; OE Type Thermostat .....	◆○14369	195	2005-2003; OE Type Thermostat .....	◆13359	195
V-8 5.7 L				◇13352	205
2010-2006; OE Exact Thermostat .....	◆○48792	203		◇13358	180
<b>Compass</b>				◇13356	160
4-Cyl. 2.4 L			2005-2003; Economy Thermostat .....	◆13009	195
2008; OE Type Thermostat .....	◆○14678	180		◇13008	180
<b>Grand Cherokee</b>				◇13006	160
6-Cyl. 4.0 L			2002-1997; Premium Thermostat .....	◆45359	195
2004-1995; Premium Thermostat .....	◆45359	195		◇45358	180
	◇45358	180		◇45356	160
2004-1995; Economy Thermostat .....	◆13009	195	2002-1997; Economy Thermostat .....	◆13009	195
	◇13008	180		◇13008	180
	◇13006	160		◇13006	160
V-6 3.7 L			<b>Wrangler</b>		
2010-2005; OE Type Thermostat .....	◆○14369	195	4-Cyl. 2.4 L		
V-8 4.7 L			2006-2003; Premium Thermostat .....	◆45209	195
2009-1999; OE Type Thermostat .....	◆○14369	195	2006-2003; OE Type Thermostat .....	◆14209	195
V-8 5.2 L			4-Cyl. 2.5 L		
1998-1995; Premium Thermostat .....	◆45359	195	2002-1997; Premium Thermostat .....	◆45359	195
	◇45358	180		◇45358	180
	◇45356	160		◇45356	160
1998-1995; Economy Thermostat .....	◆13009	195	2002-1997; Economy Thermostat .....	◆13009	195
	◇13008	180		◇13008	180
	◇13006	160		◇13006	160
V-8 5.7 L			1995; Premium Thermostat .....	◆45359	195
2010-2005; OE Exact Thermostat .....	◆○48792	203		◇45358	180
				◇45356	160
			1995; Economy Thermostat .....	◆13009	195
				◇13008	180
				◇13006	160

◆ OE Temperature.  
○ Seal Included.

◇ Alternate Temperature.

# Thermostats for Passenger Cars and Light Trucks (1990 and Newer)

Application	Part Number	Temp°F	Application	Part Number	Temp°F
<b>Jeep - Continued</b>			<b>Kia - Continued</b>		
<b>Wrangler - Continued</b>			<b>Optima - Continued</b>		
<b>6-Cyl. 4.0 L</b>			<b>4-Cyl. 2.4 L - Continued</b>		
2006; Premium Thermostat .....	◆45359	195	2006-2001; OE Type Thermostat .....	◆○14808	180
	◇45358	180	<b>V-6 2.5 L</b>		
	◇45356	160	2001; OE Type Thermostat .....	◆14128	180
2006; Economy Thermostat .....	◆13009	195		◇14127	170
	◇13008	180	<b>V-6 2.7 L</b>		
	◇13006	160	2010-2007; OE Type Thermostat .....	◆14128	180
2005-2003; Premium Thermostat .....	◆45359	195	2006-2002; OE Type Thermostat .....	◆14128	180
	◇45358	180		◇14127	170
	◇45356	160	<b>Rio</b>		
2005-2003; OE Type Thermostat .....	◆13359	195	<b>4-Cyl. 1.5 L</b>		
	◇13352	205	2002-2001; Premium Thermostat .....	◆45869	195
	◇13358	180		◇45868	180
	◇13356	160	<b>4-Cyl. 1.6 L</b>		
2005-2003; Economy Thermostat .....	◆13009	195	2011; OE Exact Thermostat .....	◆48588	180
	◇13008	180	2011; OE Type Thermostat .....	◆14648	180
	◇13006	160	2009; OE Type Thermostat .....	◆14648	180
2002-1997; Premium Thermostat .....	◆45359	195	2008-2006; OE Exact Thermostat .....	◆48588	180
	◇45358	180	2008-2006; OE Type Thermostat .....	◆14648	180
	◇45356	160	2005-2003; Premium Thermostat .....	◆45869	195
2002-1997; Economy Thermostat .....	◆13009	195		◇45868	180
	◇13008	180	2005-2003; OE Type Thermostat .....	◆13869	195
	◇13006	160		◇13868	180
1995; Premium Thermostat .....	◆45359	195	<b>Rondo</b>		
	◇45358	180	<b>4-Cyl. 2.4 L</b>		
	◇45356	160	2010-2007; OE Exact Thermostat .....	◆48588	180
1995; Economy Thermostat .....	◆13009	195	2010-2007; OE Type Thermostat .....	◆14648	180
	◇13008	180	<b>V-6 2.7 L</b>		
	◇13006	160	2009-2007; OE Type Thermostat .....	◆14128	180
<b>V-6 3.8 L</b>			<b>Sedona</b>		
2010-2007; Premium Thermostat .....	◆45209	195	<b>V-6 3.5 L</b>		
2010-2007; OE Type Thermostat .....	◆14209	195	2005-2002; OE Type Thermostat .....	◆14128	180
				◇14127	170
<b>YJ</b>			<b>Sephia</b>		
<b>4-Cyl. 2.5 L (Canada); 6-Cyl. 4.0 L (Canada)</b>			<b>4-Cyl. 1.6 L</b>		
1995; Premium Thermostat .....	◆45359	195	1997-1996; Premium Thermostat .....	◆45869	195
	◇45358	180		◇45868	180
	◇45356	160	1997-1996; OE Type Thermostat .....	◆13869	195
1995; Economy Thermostat .....	◆13009	195		◇13868	180
	◇13008	180	1995; Premium Thermostat; W/DOHC Eng. ....	◆45869	195
	◇13006	160		◇45868	180
<b>Kia</b>			1995; OE Type Thermostat; W/DOHC Eng. ....	◆13869	195
<b>Amanti</b>				◇13868	180
<b>V-6 3.5 L</b>			1995; Premium Thermostat; W/DOHC Eng. ....	◆45869	195
2006-2004; OE Type Thermostat .....	◆14128	180		◇45868	180
	◇14127	170	1995; OE Type Thermostat; W/DOHC Eng. ....	◆13869	195
<b>Forte</b>				◇13868	180
<b>4-Cyl. 2.0 L; 4-Cyl. 2.4 L</b>			1995; Premium Thermostat; W/SOHC Eng. ....	◆45869	195
2011-2010; OE Type Thermostat .....	◆14648	180		◇45868	180
<b>Magentis</b>			<b>4-Cyl. 1.8 L</b>		
<b>4-Cyl. 2.4 L (Canada)</b>			2001-1998; Premium Thermostat .....	◆45868	180
2009; OE Type Thermostat .....	◆14648	180		◇45869	195
2006-2001; OE Exact Thermostat .....	◆○48268	180	2001-1998; OE Type Thermostat .....	◆13868	180
2006-2001; OE Type Thermostat .....	◆○14808	180		◇13869	195
<b>V-6 2.5 L (Canada)</b>			1997-1995; Premium Thermostat .....	◆45869	195
2001; OE Type Thermostat .....	◆14128	180		◇45868	180
	◇14127	170	1997-1995; OE Type Thermostat .....	◆13869	195
<b>V-6 2.7 L (Canada)</b>				◇13868	180
2006-2002; OE Type Thermostat .....	◆14128	180	<b>Sorento</b>		
	◇14127	170	<b>4-Cyl. 2.4 L</b>		
<b>Optima</b>			2011; OE Type Thermostat .....	◆14648	180
<b>4-Cyl. 2.0 L</b>			2011; OE Exact Thermostat .....	◆48588	180
2011; OE Exact Thermostat .....	◆48588	180	<b>V-6 3.5 L</b>		
2011; OE Type Thermostat .....	◆14648	180	2006-2003; OE Type Thermostat .....	◆14128	180
<b>4-Cyl. 2.4 L</b>				◇14127	170
2011-2007; OE Exact Thermostat .....	◆48588	180	<b>Soul</b>		
2011-2007; OE Type Thermostat .....	◆14648	180	<b>4-Cyl. 1.6 L; 4-Cyl. 2.0 L</b>		
2006-2001; OE Exact Thermostat .....	◆○48268	180	2011-2010; OE Type Thermostat .....	◆14648	180

◆ OE Temperature.  
○ Seal Included.

◇ Alternate Temperature.

## Thermostats for Passenger Cars and Light Trucks (1990 and Newer)

Application	Part Number	Temp°F	Application	Part Number	Temp°F
<b>Kia - Continued</b>			<b>Lexus - Continued</b>		
<b>Spectra</b>			<b>GX470</b>		
4-Cyl. 1.8 L			V-8 4.7 L		
2004-2000; Premium Thermostat .....	◆45868	180	2009-2003; OE Type Thermostat .....	◆14128	180
	◇45869	195		◇14127	170
2004-2000; OE Type Thermostat .....	◆13868	180			
	◇13869	195	<b>HS250h</b>		
4-Cyl. 2.0 L			4-Cyl. 2.4 L Electric Assist		
2009; OE Type Thermostat .....	◆14648	180	2011; OE Type Thermostat .....	◆14078	180
2008-2004; OE Exact Thermostat .....	◆48588	180	2011; OE Exact Thermostat .....	◆48128	180
2008-2004; OE Type Thermostat .....	◆14648	180	2010; OE Exact Thermostat .....	◆48128	180
			2010; OE Type Thermostat .....	◆14078	180
<b>Sportage</b>			<b>IS300</b>		
4-Cyl. 2.0 L			6-Cyl. 3.0 L		
2010-2005; OE Exact Thermostat .....	◆48588	180	2005-2001; OE Exact Thermostat .....	◆48308	180
2010-2005; OE Type Thermostat .....	◆14648	180	2005-2001; OE Type Thermostat .....	◆14108	180
2002; Premium Thermostat .....	◆45868	180			
	◇45869	195	<b>LS400</b>		
2001-1995; Premium Thermostat .....	◆45869	195	V-8 4.0 L		
	◇45868	180	2000-1995; OE Exact Thermostat .....	◆48128	180
			2000-1995; OE Type Thermostat .....	◆14078	180
4-Cyl. 2.4 L				◇14077	170
2011; OE Exact Thermostat .....	◆48588	180	<b>LS430</b>		
2011; OE Type Thermostat .....	◆14648	180	V-8 4.3 L		
V-6 2.7 L			2006-2001; OE Type Thermostat .....		
2010; OE Type Thermostat .....	◆14128	180		◆14128	180
2009-2005; OE Type Thermostat .....	◆14128	180		◇14127	170
	◇14127	170	<b>LX450</b>		
<b>Lexus</b>			6-Cyl. 4.5 L		
<b>ES300</b>			1997-1996; OE Type Thermostat .....		
V-6 3.0 L				◆14128	180
2003-1995; OE Exact Thermostat .....	◆48128	180		◇14127	170
2003-1995; OE Type Thermostat .....	◆14078	180	<b>LX470</b>		
	◇14077	170	V-8 4.7 L		
<b>ES330</b>			2007-2001; OE Type Thermostat .....		
V-6 3.3 L				◆14128	180
2006-2004; OE Exact Thermostat .....	◆48128	180		◇14127	170
2006-2004; OE Type Thermostat .....	◆14078	180	2000; OE Type Thermostat .....	◆14128	180
	◇14077	170		◇14077	170
<b>ES350</b>			1999-1998; OE Type Thermostat .....		
V-6 3.5 L				◆14128	180
2011; OE Type Thermostat .....	◆14078	180		◇14127	170
2009-2007; OE Type Thermostat .....	◆14078	180	<b>RX300</b>		
<b>GS300</b>			V-6 3.0 L		
6-Cyl. 3.0 L			2003-1999; OE Type Thermostat .....		
2005-1995; OE Exact Thermostat .....	◆48308	180		◆14078	180
2005-1995; OE Type Thermostat .....	◆14108	180		◇14077	170
<b>GS400</b>			<b>RX330</b>		
V-8 4.0 L			V-6 3.3 L		
2000; OE Type Thermostat .....	◆14078	180	2006; OE Exact Thermostat .....	◆48128	180
	◇14077	170	2006; OE Type Thermostat .....	◆14078	180
1999; OE Exact Thermostat; Early .....	◆48128	180		◇14077	170
1999; OE Type Thermostat; Early .....	◆14078	180	2005-2004; OE Type Thermostat .....	◆14078	180
	◇14077	170		◇14077	170
1999; OE Type Thermostat; Late .....	◆14128	180	<b>RX350</b>		
	◇14127	170	V-6 3.5 L		
1998; OE Type Thermostat .....	◆14078	180	2011-2010; OE Type Thermostat .....	◆14078	180
	◇14077	170	2009-2007; OE Type Thermostat; Models made in USA.	◆14078	180
				◇14077	170
<b>GS430</b>			<b>RX400h</b>		
V-8 4.3 L			V-6 3.3 L Electric Assist		
2007; OE Type Thermostat .....	◆14128	180	2008-2007; OE Exact Thermostat .....	◆48128	180
	◇14127	170	2008-2007; OE Type Thermostat .....	◆14078	180
2006; OE Type Thermostat .....	◆14128	180	2006; OE Exact Thermostat .....	◆48128	180
2005-2001; OE Type Thermostat .....	◆14128	180	2006; OE Type Thermostat .....	◆14078	180
	◇14127	170		◇14077	170
			<b>RX450h</b>		
			V-6 3.5 L Electric Assist		
			2011-2010; OE Type Thermostat .....		
				◆14078	180

◆ OE Temperature.

◇ Alternate Temperature.



# Thermostats for Passenger Cars and Light Trucks (1990 and Newer)

Application	Part Number	Temp°F	Application	Part Number	Temp°F
<b>Lexus - Continued</b>			<b>Lincoln - Continued</b>		
<b>SC300</b>			<b>MKZ</b>		
6-Cyl. 3.0 L			V-6 3.5 L		
2000-1995: OE Exact Thermostat .....	◆48308	180	2011-2010: OE Type Thermostat .....	◆14138	180
2000-1995: OE Type Thermostat .....	◆14108	180	2009: OE Type Thermostat .....	◆14138	180
<b>SC400</b>			2008-2007: OE Type Thermostat .....		
V-8 4.0 L			◆14138 180		
2000-1998: OE Exact Thermostat .....	◆48298	180	<b>Navigator</b>		
2000-1998: OE Type Thermostat .....	◆14128	180	V-8 5.4 L		
1997-1995: OE Exact Thermostat .....	◆48128	180	2011-2010: Premium Thermostat .....		
1997-1995: OE Type Thermostat .....	◆14078	180	◆45779 195		
	◇14077	170	2011-2010: OE Type Thermostat .....		
<b>SC430</b>			◆45779 195		
V-8 4.3 L			2009: Premium Thermostat .....		
2010: OE Type Thermostat .....	◆14128	180	◇45778 180		
2009-2008: OE Type Thermostat .....	◆14128	180	◆13779 195		
	◇14127	170	2009: OE Type Thermostat .....		
2007-2006: OE Type Thermostat .....	◆14128	180	◆13779 195		
2005-2002: OE Type Thermostat .....	◆14128	180	◇13778 180		
	◇14127	170	2008-2007: Premium Thermostat .....		
<b>Lincoln</b>			2008-2007: OE Type Thermostat .....		
<b>Aviator</b>			◆45779 195		
V-8 4.6 L			2008-2007: OE Type Thermostat .....		
2005-2003: OE Type Thermostat .....	◆14138	180	◆13779 195		
	◇14139	188	2006-1998: Premium Thermostat .....		
<b>Blackwood</b>			◆45778 180		
V-8 5.4 L			◆45779 195		
2002: Premium Thermostat .....	◆45779	195	◆13779 195		
	◇45778	180	2005-2004: Premium Thermostat .....		
2002: OE Type Thermostat .....	◆13779	195	◆45779 195		
	◇13778	180	◇45778 180		
<b>Continental</b>			2005-2004: OE Type Thermostat .....		
V-8 4.6 L			◆13779 195		
2002-1995: OE Type Thermostat .....	◆14089	188	◇13778 180		
<b>LS</b>			2003-1995: Premium Thermostat .....		
V-6 3.0 L			◆45399 195		
2005-2000: OE Type Thermostat .....	◆14139	188	◇45398 180		
	◇14138	180	2003-1995: OE Type Thermostat .....		
V-8 3.9 L			◆13399 195		
2003: OE Type Thermostat: Oct. 31 & Older .....	◆○14748	183	◇13398 180		
2002-2000: OE Type Thermostat .....	◆○14748	183	<b>Zephyr</b>		
<b>Mark LT</b>			V-6 3.0 L		
V-8 5.4 L			2006: OE Type Thermostat .....		
2008-2006: Premium Thermostat .....	◆45779	195	◆14139 188		
2008-2006: OE Type Thermostat .....	◆13779	195	◇14138 180		
<b>Mark VIII</b>			<b>Mazda</b>		
V-8 4.6 L			<b>2</b>		
1998-1995: OE Type Thermostat .....	◆14089	188	4-Cyl. 1.5 L		
<b>MKS</b>			2011: OE Exact Thermostat .....		
V-6 3.5 L			◆○48478 180		
2011-2010: OE Type Thermostat .....	◆14138	180	<b>3</b>		
V-6 3.7 L	◆14138	180	4-Cyl. 2.0 L; 4-Cyl. 2.3 L		
2011-2009: OE Type Thermostat .....	◆14138	180	2010-2004: OE Exact Thermostat Water Outlet		
<b>MKT</b>			Assembly .....		
V-6 3.5 L; V-6 3.7 L			◆○48728 180		
2011-2010: OE Type Thermostat .....	◆14138	180	4-Cyl. 2.5 L		
<b>MKX</b>			2010: OE Exact Thermostat Water Outlet Assembly .....		
V-6 3.5 L			◆○48728 180		
2010-2007: OE Type Thermostat .....	◆14138	180	<b>5</b>		
V-6 3.7 L	◆14138	180	4-Cyl. 2.3 L		
2011: OE Type Thermostat .....	◆14138	180	2010-2006: OE Exact Thermostat Water Outlet		
<b>Lincoln</b>			Assembly .....		
<b>Aviator</b>			◆○48728 180		
V-8 4.6 L			<b>6</b>		
1998-1995: OE Type Thermostat .....			4-Cyl. 2.3 L		
◆14089 188			2008-2003: OE Exact Thermostat Water Outlet		
<b>MKS</b>			Assembly .....		
V-6 3.5 L			◆○48728 180		
2011-2010: OE Type Thermostat .....	◆14138	180	4-Cyl. 2.5 L		
V-6 3.7 L	◆14138	180	2010: OE Exact Thermostat Water Outlet Assembly .....		
2011-2009: OE Type Thermostat .....	◆14138	180	◆○48728 180		
<b>MKT</b>			V-6 3.0 L		
V-6 3.5 L; V-6 3.7 L			2008-2007: OE Type Thermostat .....		
2011-2010: OE Type Thermostat .....	◆14138	180	◆14139 188		
<b>MKX</b>			◆45359 195		
V-6 3.5 L			◇45358 180		
2010-2007: OE Type Thermostat .....	◆14138	180	◇45356 160		
V-6 3.7 L	◆14138	180			
2011: OE Type Thermostat .....	◆14138	180			

◆ OE Temperature.  
○ Seal Included.

◇ Alternate Temperature.

## Thermostats for Passenger Cars and Light Trucks (1990 and Newer)

Application	Part Number	Temp°F	Application	Part Number	Temp°F
<b>Mazda - Continued</b>			<b>Mazda - Continued</b>		
<b>6 - Continued</b>			<b>B3000 Pickup - Continued</b>		
V-6 3.0 L - Continued			V-6 3.0 L (Canada)		
2006-2003; Economy Thermostat .....	◆13009	195	2008; Premium Thermostat .....	◆45359	195
	◆13008	180		◆45358	180
	◆13006	160		◆45356	160
<b>626</b>			2008; OE Type Thermostat .....	◆13859	195
4-Cyl. 2.0 L; V-6 2.5 L				◆13858	180
2002-1995; OE Exact Thermostat .....	◆○48478	180	2008; Economy Thermostat .....	◆13009	195
2002-1995; OE Type Thermostat .....	◆14048	180		◆13008	180
	◆14047	170		◆13006	160
<b>929</b>			<b>B4000 Pickup</b>		
V-6 3.0 L			V-6 4.0 L		
1995; OE Exact Thermostat .....	◆○48358	180	2009; OE Type Thermostat .....	◆13649	190
1995; OE Type Thermostat .....	◆14168	180		◆13648	180
<b>B2300 Pickup</b>			2008-2004; OE Exact Thermostat .....	◆48099	198
4-Cyl. 2.3 L			2008-2004; OE Type Thermostat .....	◆13649	190
2009-2007; OE Exact Thermostat Water Outlet			2003-2002; OE Type Thermostat .....	◆13649	190
Assembly .....	◆○48708	180		◆13648	180
2006-2004; OE Exact Thermostat Water Outlet			2001; OE Type Thermostat .....	◆13649	190
Assembly .....	◆○48689	194	2000-1995; Premium Thermostat .....	◆45369	195
2003-2002; OE Exact Thermostat Water Outlet				◆45368	180
Assembly; W/O Sensor .....	◆○48672	208	2000-1995; OE Type Thermostat .....	◆13959	195
2001; OE Exact Thermostat Water Outlet Assembly .....	◆○48672	208		◆13958	180
1997-1995; Premium Thermostat .....	◆○45829	195	V-6 4.0 L (Canada)		
	◆○45828	180	2010; OE Type Thermostat .....	◆13649	190
	◆○45820	192		◆13648	180
1997-1995; OE Type Thermostat .....	◆○13829	195	<b>CX-7</b>		
	◆○13828	180	4-Cyl. 2.3 L		
	◆○13820	192	2010-2007; OE Exact Thermostat Water Outlet		
<b>B2500 Pickup</b>			Assembly .....	◆○48728	180
4-Cyl. 2.5 L			4-Cyl. 2.5 L		
2001; Premium Thermostat .....	◆○45990	192	2010; OE Exact Thermostat Water Outlet Assembly .....	◆○48728	180
2001; OE Type Thermostat .....	◆○14990	192	<b>CX-9</b>		
2000-1999; OE Type Thermostat .....	◆○14990	192	V-6 3.7 L		
1998; Premium Thermostat .....	◆○45990	192	2010-2008; OE Type Thermostat .....	◆14138	180
1998; OE Type Thermostat .....	◆○14990	192	<b>Millenia</b>		
<b>B3000 Pickup</b>			V-6 2.3 L; V-6 2.5 L		
V-6 3.0 L			2002-1995; OE Exact Thermostat .....	◆○48478	180
2007-1999; Premium Thermostat .....	◆45359	195	2002-1995; OE Type Thermostat .....	◆14048	180
	◆45358	180		◆14047	170
	◆45356	160	<b>MPV</b>		
2007-1999; OE Type Thermostat .....	◆13859	195	V-6 2.5 L		
	◆13858	180	2001-2000; OE Type Thermostat .....	◆14139	188
2007-1999; Economy Thermostat .....	◆13009	195		◆14138	180
	◆13008	180	V-6 3.0 L		
	◆13006	160	2006-2004; Premium Thermostat .....	◆45359	195
1998; Premium Thermostat .....	◆45359	195		◆45358	180
	◆45358	180		◆45356	160
1998; Economy Thermostat .....	◆13009	195	2006-2004; Economy Thermostat .....	◆13009	195
	◆13008	180		◆13008	180
	◆13006	160		◆13006	160
1996; Premium Thermostat .....	◆45359	195	2003; OE Type Thermostat; Early .....	◆14139	188
	◆45358	180		◆14138	180
	◆45356	160	2002; OE Type Thermostat .....	◆14139	188
1996; Economy Thermostat .....	◆13009	195		◆14138	180
	◆13008	180	1998-1996; OE Exact Thermostat .....	◆○48478	180
	◆13006	160	1998-1996; OE Type Thermostat .....	◆14048	180
1995; Premium Thermostat .....	◆45359	195		◆14047	170
	◆45358	180	1995; OE Exact Thermostat .....	◆○48358	180
	◆45356	160	1995; OE Type Thermostat .....	◆14168	180
1995; OE Type Thermostat .....	◆13359	195	<b>MX-3</b>		
	◆13352	205	4-Cyl. 1.6 L		
	◆13358	180	1995; Premium Thermostat .....	◆45869	195
	◆13356	160		◆45868	180
1995; Economy Thermostat .....	◆13009	195	1995; OE Type Thermostat .....	◆13869	195
	◆13008	180		◆13868	180
	◆13006	160			

◆ OE Temperature.  
○ Seal Included.

◆ Alternate Temperature.

## Thermostats for Passenger Cars and Light Trucks (1990 and Newer)

Application	Part Number	Temp°F	Application	Part Number	Temp°F
<b>Mazda - Continued</b>			<b>Mazda - Continued</b>		
<b>MX-3 - Continued</b>			<b>Protege - Continued</b>		
4-Cyl. 1.6 L (Canada)			4-Cyl. 2.0 L - Continued		
1996; Premium Thermostat .....	◆45869	195	2002-2001; OE Type Thermostat .....	◆14048	180
	◆45868	180		◆14047	170
1996; OE Type Thermostat .....	◆13869	195			
	◆13868	180	<b>RX-7</b>		
V-6 1.8 L (Canada)			2-Rotor 1.3 L		
1995; OE Type Thermostat .....	◆14048	180	1995; OE Exact Thermostat .....	◆○48438	180
	◆14047	170	1995; OE Type Thermostat .....	◆13978	180
				◆13979	195
<b>MX-5 Miata</b>			<b>RX-8</b>		
4-Cyl. 1.8 L			2-Rotor 1.3 L		
2005-2001; OE Exact Thermostat .....	◆48608	185	2010-2004; OE Exact Thermostat .....	◆○48478	180
2005-2001; Premium Thermostat .....	◆45868	180			
	◆45869	195	<b>Tribute</b>		
2005-2001; OE Type Thermostat .....	◆13868	180	4-Cyl. 2.0 L		
	◆13869	195	2004-2001; OE Exact Thermostat .....	◆48109	198
2000-1999; OE Exact Thermostat .....	◆48608	185	2004-2001; Premium Thermostat .....	◆45979	195
2000-1999; Premium Thermostat .....	◆45869	195		◆45978	180
	◆45868	180	2004-2001; OE Type Thermostat .....	◆13979	195
2000-1999; OE Type Thermostat .....	◆13869	195		◆13978	180
	◆13868	180	4-Cyl. 2.3 L		
1997; OE Exact Thermostat .....	◆48608	185	2008; OE Exact Thermostat Water Outlet Assembly .....	◆○48689	194
1997; Premium Thermostat .....	◆45869	195	2006-2005; OE Exact Thermostat Water Outlet Assembly .....	◆○48689	194
	◆45868	180	4-Cyl. 2.3 L Electric Assist		
1997; OE Type Thermostat .....	◆13869	195	2008; OE Exact Thermostat Water Outlet Assembly .....	◆○48689	194
	◆13868	180	4-Cyl. 2.5 L		
1996-1995; Premium Thermostat .....	◆45869	195	2011-2009; OE Exact Thermostat Water Outlet Assembly .....	◆○48689	194
	◆45868	180	4-Cyl. 2.5 L Electric Assist		
1996-1995; OE Type Thermostat .....	◆13869	195	2010-2009; OE Exact Thermostat Water Outlet Assembly .....	◆○48728	180
	◆13868	180			
4-Cyl. 2.0 L			V-6 3.0 L		
2010-2006; OE Exact Thermostat Water Outlet Assembly .....	◆○48728	180	2011-2010; Premium Thermostat .....	◆45359	195
			2011-2010; OE Type Thermostat .....	◆13359	195
<b>MX-6</b>			2011-2010; Economy Thermostat .....	◆13009	195
4-Cyl. 2.0 L; V-6 2.5 L			2009-2008; Premium Thermostat .....	◆45359	195
1997-1995; OE Exact Thermostat .....	◆○48478	180		◆45358	180
1997-1995; OE Type Thermostat .....	◆14048	180		◆45356	160
	◆14047	170		◆13359	195
				◆13352	205
<b>Protege</b>				◆13358	180
4-Cyl. 1.5 L				◆13356	160
1998-1995; OE Exact Thermostat .....	◆48608	185		◆13009	195
1998-1995; Premium Thermostat .....	◆45868	180		◆13008	180
	◆45869	195		◆13006	160
1998-1995; OE Type Thermostat .....	◆13868	180		◆45359	195
	◆13869	195		◆45358	180
4-Cyl. 1.6 L				◆45356	160
2001-1999; OE Exact Thermostat .....	◆48608	185		◆13359	195
2001-1999; Premium Thermostat .....	◆45868	180		◆13352	205
	◆45869	195		◆13358	180
2001-1999; OE Type Thermostat .....	◆13868	180		◆13356	160
	◆13869	195		◆13009	195
4-Cyl. 1.8 L				◆13008	180
2000-1999; OE Exact Thermostat .....	◆○48478	180		◆13006	160
2000-1999; OE Type Thermostat .....	◆14048	180		◆45359	195
	◆14047	170		◆45358	180
1998-1995; OE Exact Thermostat .....	◆48608	185		◆45356	160
1998-1995; Premium Thermostat .....	◆45868	180		◆13359	195
	◆45869	195		◆13352	205
1998-1995; OE Type Thermostat .....	◆13868	180		◆13358	180
	◆13869	195		◆13356	160
4-Cyl. 2.0 L				◆13009	195
2003; OE Exact Thermostat; W/Turbo .....	◆○48478	180		◆13008	180
2003; OE Type Thermostat; W/Turbo .....	◆14048	180		◆13006	160
	◆14047	170		◆45359	195
2003; Premium Thermostat; W/O Turbo .....	◆45869	195		◆45358	180
	◆45868	180		◆45356	160
2003; OE Type Thermostat; W/O Turbo .....	◆13869	195		◆13359	195
	◆13868	180		◆13352	205
2002-2001; OE Exact Thermostat .....	◆○48478	180		◆13358	180
				◆13356	160
				◆13009	195
				◆13008	180
				◆13006	160
				◆14139	188
				◆14138	180
			<b>Mercedes-Benz</b>		
			<b>C32</b>		
			V-6 3.2 L		
			2004-2002; Thermostat Water Outlet Assembly .....	◆○14569	188
			<b>C36</b>		
			6-Cyl. 3.6 L		
			1997-1995; OE Exact Thermostat .....	◆○48019	189
			<b>C43</b>		
			V-8 4.3 L		
			2000-1998; Thermostat Water Outlet Assembly .....	◆○14569	188

◆ OE Temperature.  
○ Seal Included.

◆ Alternate Temperature.

## Thermostats for Passenger Cars and Light Trucks (1990 and Newer)

Application	Part Number	Temp°F	Application	Part Number	Temp°F
<b>Mercedes-Benz - Continued</b>			<b>Mercedes-Benz - Continued</b>		
<b>C55</b>			<b>E420</b>		
V-8 5.5 L 2006-2005; Thermostat Water Outlet Assembly .....	◆○14569	188	V-8 4.2 L 1997; OE Type Thermostat; 1st Design .....	◆○14578	176
			1997; Thermostat Water Outlet Assembly; 2nd Design .	◆○14598	176
<b>C220</b>			1995; OE Type Thermostat; 1st Design .....	◆○14578	176
4-Cyl. 2.2 L 1996-1995; Thermostat Water Outlet Assembly .....	◆○14589	188	1995; Thermostat Water Outlet Assembly; 2nd Design .	◆○14598	176
<b>C230</b>			<b>E430</b>		
4-Cyl. 1.8 L 2005-2003; OE Exact Thermostat .....	◆○48829	194	V-8 4.3 L 2002-1998; Thermostat Water Outlet Assembly .....	◆○14569	188
4-Cyl. 2.3 L 2000-1997; Thermostat Water Outlet Assembly .....	◆○14589	188	<b>E500</b>		
<b>C240</b>			V-8 5.0 L 2006-2003; Thermostat Water Outlet Assembly .....	◆○14569	188
V-6 2.6 L 2005-2001; Thermostat Water Outlet Assembly .....	◆○14569	188	<b>G55</b>		
<b>C280</b>			V-8 5.5 L 2006-2003; Thermostat Water Outlet Assembly .....	◆○14569	188
6-Cyl. 2.8 L 1997-1995; OE Exact Thermostat .....	◆○48019	189	<b>G500</b>		
V-6 2.8 L 2000-1998; Thermostat Water Outlet Assembly .....	◆○14569	188	V-8 5.0 L 2008-2002; Thermostat Water Outlet Assembly .....	◆○14569	188
<b>C320</b>			<b>ML55</b>		
V-6 3.2 L 2005-2001; Thermostat Water Outlet Assembly .....	◆○14569	188	V-8 5.5 L 2003-2000; Thermostat Water Outlet Assembly .....	◆○14569	188
<b>CL55</b>			<b>ML320</b>		
V-8 5.5 L 2006-2001; Thermostat Water Outlet Assembly .....	◆○14569	188	V-6 3.2 L 2003-1998; Thermostat Water Outlet Assembly .....	◆○14569	188
<b>CL500</b>			<b>ML350</b>		
V-8 5.0 L 2006-1998; Thermostat Water Outlet Assembly .....	◆○14569	188	V-6 3.7 L 2005-2003; Thermostat Water Outlet Assembly .....	◆○14569	188
<b>CLK55</b>			<b>ML430</b>		
V-8 5.5 L 2006-2001; Thermostat Water Outlet Assembly .....	◆○14569	188	V-8 4.3 L 2001-1999; Thermostat Water Outlet Assembly .....	◆○14569	188
<b>CLK320</b>			<b>ML500</b>		
V-6 3.2 L 2005-1998; Thermostat Water Outlet Assembly .....	◆○14569	188	V-8 5.0 L 2007-2002; Thermostat Water Outlet Assembly .....	◆○14569	188
<b>CLK430</b>			<b>R500</b>		
V-8 4.3 L 2003-1999; Thermostat Water Outlet Assembly .....	◆○14569	188	V-8 5.0 L 2007-2006; Thermostat Water Outlet Assembly .....	◆○14569	188
<b>CLK500</b>			<b>S55</b>		
V-8 5.0 L 2006-2003; Thermostat Water Outlet Assembly .....	◆○14569	188	V-8 5.5 L 2005-2001; Thermostat Water Outlet Assembly .....	◆○14569	188
<b>CLS500</b>			<b>S320</b>		
V-8 5.0 L 2006; Thermostat Water Outlet Assembly .....	◆○14569	188	6-Cyl. 3.2 L 1999-1995; OE Exact Thermostat .....	◆○48019	189
<b>E55</b>			<b>S350</b>		
V-8 5.5 L 2005-2004; Thermostat Water Outlet Assembly .....	◆○14569	188	V-6 3.7 L 2006; Thermostat Water Outlet Assembly .....	◆○14569	188
2002-1999; Thermostat Water Outlet Assembly .....	◆○14569	188	<b>S350D</b>		
<b>E300</b>			6-Cyl. 3.5 L Diesel 1995; OE Exact Thermostat .....	◆○48658	176
6-Cyl. 3.0 L Diesel 1999-1998; OE Exact Thermostat .....	◆○48658	176	1995; OE Type Thermostat .....	◆13588	176
1999-1998; OE Type Thermostat .....	◆13588	176	<b>S420</b>		
<b>E300D</b>			V-8 4.2 L 1999-1998; OE Type Thermostat; 1st Design .....	◆○14578	176
6-Cyl. 3.0 L Diesel 1997-1996; OE Type Thermostat .....	◆13588	176	1999-1998; Thermostat Water Outlet Assembly; 2nd Design .....	◆○14598	176
<b>E320</b>			1997; Thermostat Water Outlet Assembly; 2nd Design .	◆○14598	176
6-Cyl. 3.2 L 1997-1995; OE Exact Thermostat .....	◆○48019	189	1997; OE Type Thermostat; 1st Design .....	◆○14578	176
V-6 3.2 L 2005-1998; Thermostat Water Outlet Assembly .....	◆○14569	188	1996-1995; OE Type Thermostat; 1st Design .....	◆○14578	176
			1996-1995; Thermostat Water Outlet Assembly; 2nd Design .....	◆○14598	176

◆ OE Temperature.

○ Seal Included.



## Thermostats for Passenger Cars and Light Trucks (1990 and Newer)

Application	Part Number	Temp°F	Application	Part Number	Temp°F
<b>Mercury - Continued</b>			<b>Mercury - Continued</b>		
<b>Montego</b>			<b>Sable - Continued</b>		
<b>V-6 3.0 L</b>			<b>V-6 3.0 L - Continued</b>		
2007; OE Type Thermostat .....	◆14138	180	1999; OE Type Thermostat; W/O.H.V. Eng. ....	◆13859	195
2006-2005; OE Type Thermostat .....	◆14138	180		◇13858	180
	◇14139	188	1999; Economy Thermostat; W/O.H.V. Eng. ....	◆13009	195
				◇13008	180
				◇13006	160
<b>Monterey Van</b>				◆14138	180
<b>V-6 4.2 L</b>				◇14139	188
2007-2004; Premium Thermostat .....	◆45359	195	1998-1996; OE Type Thermostat; W/DOHC Eng. ....	◆13006	160
	◇45358	180		◆14138	180
	◇45356	160	1998-1996; Premium Thermostat; W/O.H.V. Eng. ....	◆45359	195
2007-2004; Economy Thermostat .....	◆13009	195		◇45358	180
	◇13008	180	1998-1996; Economy Thermostat; W/O.H.V. Eng. ....	◇45356	160
	◇13006	160		◆13009	195
				◇13008	180
<b>Mountaineer</b>				◇13006	160
<b>V-6 4.0 L</b>			1995; Premium Thermostat .....	◆45359	195
2010-2007; OE Type Thermostat .....	◆13649	190		◇45358	180
2006-1998; OE Type Thermostat .....	◆13649	190	1995; Economy Thermostat .....	◇45356	160
	◇13648	180		◆13009	195
				◇13008	180
<b>V-8 4.6 L</b>				◇13006	160
2010; Premium Thermostat .....	◆45779	195	<b>V-6 3.5 L</b>		
2010; OE Type Thermostat .....	◆13779	195	2009; OE Type Thermostat .....	◆14138	180
2009-2007; Premium Thermostat .....	◆45779	195	2008; OE Type Thermostat .....	◆14138	180
2009-2007; OE Type Thermostat .....	◆13779	195		◇14139	188
	◇13778	180	<b>V-6 3.8 L</b>		
2006-2002; Premium Thermostat .....	◆45779	195	1995; Premium Thermostat .....	◆45359	195
	◇45778	180		◇45358	180
2006-2002; OE Type Thermostat .....	◆13779	195		◇45356	160
	◇13778	180	1995; Economy Thermostat .....	◆13009	195
				◇13008	180
<b>V-8 5.0 L</b>				◇13006	160
2001-1997; Premium Thermostat .....	◆45359	195	<b>Tracer</b>		
	◇45358	180	<b>4-Cyl. 1.8 L</b>		
	◇45356	160	1996-1995; Premium Thermostat .....	◆45869	195
2001-1997; Economy Thermostat .....	◆13009	195		◇45868	180
	◇13008	180	1996-1995; OE Type Thermostat .....	◆13869	195
	◇13006	160		◇13868	180
<b>Mystique</b>			<b>4-Cyl. 1.9 L</b>		
<b>4-Cyl. 2.0 L</b>			1996-1995; Premium Thermostat .....	◆○45829	195
2000-1995; Premium Thermostat .....	◆45979	195		◇○45828	180
	◇45978	180	1996-1995; OE Type Thermostat .....	◇○45820	192
2000-1995; OE Type Thermostat .....	◆13979	195		◆○13829	195
	◇13978	180		◇○13828	180
				◇○13820	192
<b>V-6 2.5 L</b>			<b>4-Cyl. 2.0 L</b>		
2000-1997; OE Type Thermostat .....	◆14139	188	1999-1997; OE Type Thermostat .....	◆○14990	192
	◇14138	180	<b>Villager</b>		
1996-1995; OE Type Thermostat .....	◆14138	180	<b>V-6 3.0 L</b>		
	◇14139	188	1998-1995; Premium Thermostat .....	◆✖45948	180
				◇✖45947	170
<b>Sable</b>			1998-1995; OE Type Thermostat .....	◆✖13948	180
<b>V-6 3.0 L</b>				◇✖13947	170
2005-2001; OE Type Thermostat; Eng. VIN S .....	◆14139	188	<b>V-6 3.3 L</b>		
	◇14138	180	2002-1999; Premium Thermostat .....	◆✖45948	180
2005-2001; Premium Thermostat; Eng. VIN U .....	◆45359	195		◇✖45947	170
	◇45358	180	2002-1999; OE Type Thermostat .....	◆✖13948	180
	◇45356	160		◇✖13947	170
2005-2001; Economy Thermostat; Eng. VIN U .....	◆13009	195	<b>Mini</b>		
	◇13008	180	<b>Cooper</b>		
	◇13006	160	<b>4-Cyl. 1.6 L</b>		
2000; OE Type Thermostat; W/DOHC Eng. ....	◆14139	188	2008; OE Type Thermostat .....	◆14209	195
	◇14138	180	2007; OE Type Thermostat; W/O Turbo, Supercharger .	◆14209	195
2000; Premium Thermostat; W/O.H.V. Eng. ....	◆45359	195	2006-2002; OE Type Thermostat .....	◆14209	195
	◇45358	180	<b>Mitsubishi</b>		
	◇45356	160	<b>3000GT</b>		
2000; Economy Thermostat; W/O.H.V. Eng. ....	◆13009	195	<b>V-6 3.0 L</b>		
	◇13008	180	1999; OE Exact Thermostat .....	◆○48217	170
	◇13006	160			
1999; OE Type Thermostat; W/DOHC Eng. ....	◆14138	180			
	◇14139	188			
1999; Premium Thermostat; W/O.H.V. Eng. ....	◆45359	195			
	◇45358	180			
	◇45356	160			

◆ OE Temperature.  
○ Seal Included.

◇ Alternate Temperature.  
✖ Gasket Not Required. Use Silicone.

# Thermostats for Passenger Cars and Light Trucks (1990 and Newer)

Application	Part Number	Temp°F	Application	Part Number	Temp°F
<b>Mitsubishi - Continued</b>			<b>Mitsubishi - Continued</b>		
<b>3000GT - Continued</b>			<b>Galant - Continued</b>		
<b>V-6 3.0 L - Continued</b>			<b>4-Cyl. 2.4 L - Continued</b>		
1999; OE Type Thermostat .....	◆14127	170	2009-2004; OE Exact Thermostat .....	◆○48168	180
	◇14128	180	2009-2004; OE Type Thermostat .....	◆14078	180
1998-1997; Premium Thermostat; W/SOHC Eng. ....	◆45868	180		◇14077	170
	◇45869	195	2003-1999; OE Exact Thermostat .....	◆○48239	190
1998-1997; OE Type Thermostat; W/SOHC Eng. ....	◆13868	180	2003-1999; OE Type Thermostat .....	◆14389	190
	◇13869	195	1998-1995; OE Exact Thermostat .....	◆○48168	180
1998-1997; OE Exact Thermostat; W/DOHC Eng. ....	◆○48217	170	1998-1995; OE Type Thermostat .....	◆14078	180
1998-1997; OE Type Thermostat; W/DOHC Eng. ....	◆14127	170		◇14077	170
	◇14128	180	<b>V-6 3.0 L</b>		
1996-1995; OE Exact Thermostat .....	◆○48217	170	2003-2000; OE Type Thermostat .....	◆14128	180
1996-1995; OE Type Thermostat .....	◆14127	170		◇14127	170
	◇14128	180	1999; OE Exact Thermostat .....	◆○48168	180
			1999; OE Type Thermostat .....	◆14078	180
				◇14077	170
<b>Diamante</b>			<b>V-6 3.8 L</b>		
<b>V-6 3.0 L</b>			2009-2004; OE Type Thermostat .....		
1996; OE Type Thermostat .....	◆14128	180		◆14128	180
	◇14127	170		◇14127	170
1995; Premium Thermostat; W/SOHC Eng. ....	◆45869	195	<b>Lancer</b>		
	◇45868	180	<b>4-Cyl. 2.0 L</b>		
1995; OE Type Thermostat; W/SOHC Eng. ....	◆13869	195	2011-2008; OE Type Thermostat .....		
	◇13868	180	◆○48168		
1995; OE Type Thermostat; W/DOHC Eng. ....	◆14128	180	2007-2004; OE Exact Thermostat .....		
	◇14127	170	◆14078		
			2007-2004; OE Type Thermostat .....		
			◆14077		
			2003; OE Exact Thermostat; W/Turbo .....		
			◆○48168		
			2003; OE Type Thermostat; W/Turbo .....		
			◆14078		
			◆14077		
			2003; OE Type Thermostat; W/O Turbo .....		
			◆○14719		
			2002; OE Exact Thermostat .....		
			◆○48168		
			2002; OE Type Thermostat .....		
			◆14078		
			◇14077		
			<b>4-Cyl. 2.4 L</b>		
			2010-2009; OE Type Thermostat .....		
			◆○14719		
			2006-2004; OE Exact Thermostat .....		
			◆○48168		
			2006-2004; OE Type Thermostat .....		
			◆14078		
			◇14077		
			<b>Mirage</b>		
			<b>4-Cyl. 1.5 L</b>		
			2002-1997; OE Exact Thermostat .....		
			◆○48168		
			2002-1997; OE Type Thermostat .....		
			◆14078		
			◆14077		
			1996-1995; Premium Thermostat .....		
			◆45869		
			◆45868		
			1996-1995; OE Type Thermostat .....		
			◆13869		
			◆13868		
			<b>4-Cyl. 1.8 L</b>		
			2002-1995; OE Exact Thermostat .....		
			◆○48168		
			2002-1995; OE Type Thermostat .....		
			◆14078		
			◇14077		
			<b>Montero</b>		
			<b>V-6 3.0 L</b>		
			1996-1995; OE Type Thermostat .....		
			◆14128		
			◇14127		
			<b>V-6 3.5 L</b>		
			2002-1995; OE Type Thermostat .....		
			◆14128		
			◇14127		
			<b>V-6 3.8 L</b>		
			2006-2003; OE Type Thermostat .....		
			◆14128		
			◇14127		
			<b>Montero Sport</b>		
			<b>4-Cyl. 2.4 L</b>		
			1999-1997; OE Exact Thermostat .....		
			◆○48168		
			1999-1997; OE Type Thermostat .....		
			◆14078		
			◇14077		
			<b>V-6 3.0 L</b>		
			2003-1997; OE Type Thermostat .....		
			◆14128		
			◇14127		
			<b>Galant</b>		
			<b>4-Cyl. 2.4 L</b>		
			2010; OE Exact Thermostat .....		
			◆○48168		

◆ OE Temperature.  
○ Seal Included.

◇ Alternate Temperature.

# Thermostats for Passenger Cars and Light Trucks (1990 and Newer)

Application	Part Number	Temp°F	Application	Part Number	Temp°F
<b>Mitsubishi - Continued</b>			<b>Nissan - Continued</b>		
<b>Montero Sport - Continued</b>			<b>Altima - Continued</b>		
V-6 3.5 L			4-Cyl. 2.4 L - Continued		
2004-1999; OE Type Thermostat .....	◆14128	180	2001-1995; OE Type Thermostat .....	◆13967	170
	◇14127	170		◇13968	180
<b>Outlander</b>			<b>4-Cyl. 2.5 L</b>		
4-Cyl. 2.4 L			2011-2002; OE Type Thermostat - Lower .....	◆○14678	180
2010-2009; OE Type Thermostat .....	◆○14719	190	2011-2002; OE Type Thermostat - Upper .....	◆○15112	205
2008; OE Type Thermostat .....	◆14078	180	<b>4-Cyl. 2.5 L Electric Assist</b>		
	◇14077	170	2010-2007; OE Type Thermostat - Lower .....	◆○14678	180
2006-2004; OE Exact Thermostat .....	◆○48168	180	2010-2007; OE Type Thermostat - Upper .....	◆○15112	205
2006-2004; OE Type Thermostat .....	◆14078	180	<b>V-6 3.5 L</b>		
	◇14077	170	2006-2002; Thermostat Water Outlet Assembly .....	◆14778	180
2003; OE Exact Thermostat .....	◆○48239	190	<b>Armada</b>		
2003; OE Type Thermostat .....	◆14389	190	<b>V-8 5.6 L</b>		
<b>V-6 3.0 L</b>			2011-2005; OE Type Thermostat .....	◆14128	180
2011; OE Type Thermostat .....	◆14128	180		◇14127	170
2010-2007; OE Type Thermostat .....	◇14127	170	<b>Cube</b>		
<b>Pickup</b>			<b>4-Cyl. 1.8 L</b>		
4-Cyl. 2.4 L			2011-2009; OE Type Thermostat - Upper .....	◆○15112	205
1996-1995; Premium Thermostat .....	◆45869	195	<b>Frontier</b>		
	◇45868	180	<b>4-Cyl. 2.4 L</b>		
1996-1995; OE Type Thermostat .....	◆13869	195	2004-1998; OE Exact Thermostat .....	◆48447	170
	◇13868	180	2004-1998; Premium Thermostat .....	◆45967	170
<b>Raider</b>			2004-1998; OE Type Thermostat .....	◆13967	170
V-6 3.7 L				◇13968	180
2009; OE Type Thermostat .....	◆14349	190	<b>4-Cyl. 2.5 L</b>		
2008-2006; OE Type Thermostat .....	◆○14369	195	2009; OE Type Thermostat .....	◆○14678	180
<b>V-8 4.7 L</b>			2008-2007; OE Type Thermostat - Lower .....	◆○14678	180
2007-2006; OE Type Thermostat .....	◆○14369	195	2006-2005; OE Type Thermostat - Lower .....	◆○14678	180
<b>Nissan</b>			2006-2005; OE Type Thermostat - Upper .....	◆○15112	205
<b>200SX</b>			<b>V-6 3.3 L</b>		
4-Cyl. 1.6 L			2004-2001; OE Exact Thermostat .....	◆✖48138	180
1998-1995; OE Exact Thermostat .....	◆✖48368	180	2004-2001; Premium Thermostat .....	◆✖45948	180
1998-1995; Premium Thermostat .....	◆✖45758	180		◇✖45947	170
1998-1995; OE Type Thermostat .....	◆✖13758	180	2004-2001; OE Type Thermostat .....	◆✖13948	180
<b>4-Cyl. 2.0 L</b>				◆✖13947	170
1998-1995; OE Exact Thermostat .....	◆✖48447	170	2000-1999; OE Exact Thermostat .....	◆✖48138	180
1998-1995; Premium Thermostat .....	◆✖45967	170	2000-1999; Premium Thermostat .....	◆✖45947	170
1998-1995; OE Type Thermostat .....	◆✖13967	170		◇✖45948	180
	◇✖13968	180	2000-1999; OE Type Thermostat .....	◆✖13947	170
				◇✖13948	180
<b>240SX</b>			<b>V-6 4.0 L</b>		
4-Cyl. 2.4 L			2011-2005; Thermostat Water Outlet Assembly .....	◆14668	180
1998-1995; OE Exact Thermostat .....	◆48447	170	<b>Juke</b>		
1998-1995; Premium Thermostat .....	◆45967	170	<b>4-Cyl. 1.6 L</b>		
1998-1995; OE Type Thermostat .....	◆13967	170	2011; OE Type Thermostat - Upper .....	◆○15112	205
	◇13968	180	<b>Maxima</b>		
<b>300ZX</b>			<b>V-6 3.0 L</b>		
V-6 3.0 L			2001-1995; Thermostat Water Outlet Assembly .....	◆14318	180
1996-1995; OE Exact Thermostat .....	◆✖48177	170	<b>V-6 3.5 L</b>		
1996-1995; Premium Thermostat .....	◆✖45947	170	2008-2002; Thermostat Water Outlet Assembly .....	◆14778	180
	◇✖45948	180	<b>Murano</b>		
1996-1995; OE Type Thermostat .....	◆✖13947	170	<b>V-6 3.5 L</b>		
	◇✖13948	180	2009; Thermostat Water Outlet Assembly .....	◆14778	180
			2007-2003; Thermostat Water Outlet Assembly .....	◆14778	180
<b>350Z</b>			<b>Pathfinder</b>		
V-6 3.5 L			<b>V-6 3.0 L</b>		
2006-2003; Thermostat Water Outlet Assembly .....	◆14668	180	1995; Premium Thermostat .....	◆✖45947	170
<b>370Z</b>				◇✖45948	180
V-6 3.7 L			1995; OE Type Thermostat .....	◆✖13947	170
2010-2009; Thermostat Water Outlet Assembly .....	◆14318	180		◇✖13948	180
<b>Altima</b>			<b>V-6 3.3 L</b>		
4-Cyl. 2.4 L			2000-1998; OE Exact Thermostat .....	◆✖48138	180
2001-1995; OE Exact Thermostat .....	◆48447	170	2000-1998; Premium Thermostat .....	◆✖45947	170
2001-1995; Premium Thermostat .....	◆45967	170		◇✖45948	180

◆ OE Temperature.  
○ Seal Included.

◇ Alternate Temperature.  
✖ Gasket Not Required. Use Silicone.



# Thermostats for Passenger Cars and Light Trucks (1990 and Newer)

Application	Part Number	Temp°F	Application	Part Number	Temp°F
<b>Nissan - Continued</b>			<b>Nissan - Continued</b>		
<b>Pathfinder - Continued</b>			<b>Rogue - Continued</b>		
<b>V-6 3.3 L - Continued</b>			<b>4-Cyl. 2.5 L - Continued</b>		
2000-1998; OE Type Thermostat .....	◆✂13947	170	2011-2008; OE Type Thermostat - Upper .....	◆○15112	205
	◆✂13948	180	<b>Sentra</b>		
1997-1996; Premium Thermostat .....	◆✂45947	170	<b>4-Cyl. 1.6 L</b>		
	◆✂45948	180	1999-1995; OE Exact Thermostat .....	◆✂48368	180
1997-1996; OE Type Thermostat .....	◆✂13947	170	1999-1995; Premium Thermostat .....	◆✂45758	180
	◆✂13948	180	1999-1995; OE Type Thermostat .....	◆✂13758	180
<b>V-6 3.5 L</b>			<b>4-Cyl. 1.8 L</b>		
2004-2001; Thermostat Water Outlet Assembly .....	◆14668	180	2006; OE Type Thermostat .....	◆○14707	170
<b>V-6 4.0 L</b>			2005; OE Type Thermostat - Upper .....	◆○14707	170
2010-2005; Thermostat Water Outlet Assembly .....	◆14668	180	2004; OE Type Thermostat - Upper .....	◆○14707	170
<b>V-8 5.6 L</b>			2004; OE Type Thermostat - Lower .....	◆○14678	180
2010-2008; OE Type Thermostat .....	◆14128	180	2003; OE Type Thermostat .....	◆○14707	170
	◆14127	170	2002; OE Type Thermostat - Upper .....	◆○14707	170
2004; OE Type Thermostat .....	◆14128	180	2001-2000; OE Type Thermostat .....	◆○14707	170
	◆14127	170	<b>4-Cyl. 2.0 L</b>		
<b>Pickup</b>			2011-2007; OE Type Thermostat - Upper .....	◆○15112	205
<b>4-Cyl. 2.4 L</b>			2001-1998; OE Exact Thermostat .....	◆✂48447	170
1997-1995; OE Exact Thermostat .....	◆48447	170	2001-1998; Premium Thermostat .....	◆✂45967	170
1997-1995; Premium Thermostat .....	◆45967	170	2001-1998; OE Type Thermostat .....	◆✂13967	170
1997-1995; OE Type Thermostat .....	◆13967	170		◆✂13968	180
	◆13968	180	<b>4-Cyl. 2.5 L</b>		
<b>V-6 3.0 L</b>			2011-2002; OE Type Thermostat - Lower .....	◆○14678	180
1995; Premium Thermostat .....	◆✂45947	170	2011-2002; OE Type Thermostat - Upper .....	◆○15112	205
	◆✂45948	180	<b>Titan</b>		
1995; OE Type Thermostat .....	◆✂13947	170	<b>V-8 5.6 L</b>		
	◆✂13948	180	2010-2004; OE Type Thermostat .....	◆14128	180
<b>V-6 3.0 L (Canada)</b>				◆14127	170
1996; OE Exact Thermostat .....	◆✂48447	170	<b>Versa</b>		
1996; Premium Thermostat .....	◆✂45967	170	<b>4-Cyl. 1.8 L</b>		
1996; OE Type Thermostat .....	◆✂13967	170	2011-2007; OE Type Thermostat - Upper .....	◆○15112	205
	◆✂13968	180	<b>Xterra</b>		
<b>Quest</b>			<b>4-Cyl. 2.4 L</b>		
<b>V-6 3.0 L</b>			2004-2000; OE Exact Thermostat .....	◆48447	170
1998; OE Exact Thermostat .....	◆✂48138	180	2004-2000; Premium Thermostat .....	◆45967	170
1998; Premium Thermostat .....	◆✂45947	170	2004-2000; OE Type Thermostat .....	◆13967	170
	◆✂45948	180		◆13968	180
1998; OE Type Thermostat .....	◆✂13947	170	<b>V-6 3.3 L</b>		
	◆✂13948	180	2004-2002; OE Exact Thermostat .....	◆✂48138	180
1997-1995; Premium Thermostat .....	◆✂45947	170	2004-2002; Premium Thermostat .....	◆✂45948	180
	◆✂45948	180		◆✂45947	170
1997-1995; OE Type Thermostat .....	◆✂13947	170	2004-2002; OE Type Thermostat .....	◆✂13948	180
	◆✂13948	180		◆✂13947	170
<b>V-6 3.3 L</b>			2001-2000; OE Exact Thermostat .....	◆✂48138	180
2002; OE Exact Thermostat .....	◆✂48138	180	2001-2000; Premium Thermostat .....	◆✂45947	170
2002; Premium Thermostat .....	◆✂45948	180		◆✂45948	180
	◆✂45947	170	2001-2000; OE Type Thermostat .....	◆✂13947	170
2002; OE Type Thermostat .....	◆✂13948	180		◆✂13948	180
	◆✂13947	170	<b>V-6 4.0 L</b>		
2001; OE Exact Thermostat .....	◆✂48138	180	2012-2005; Thermostat Water Outlet Assembly .....	◆14668	180
2001; Premium Thermostat .....	◆✂45947	170	<b>Oldsmobile</b>		
2001; OE Type Thermostat .....	◆✂45948	180	<b>Achieva</b>		
	◆✂13947	170	<b>4-Cyl. 2.3 L</b>		
2000; OE Exact Thermostat .....	◆✂13948	180	1995; Premium Thermostat .....	◆45028	180
2000; Premium Thermostat .....	◆✂48138	180	1995; OE Type Thermostat .....	◆14028	180
	◆✂45947	170	<b>4-Cyl. 2.4 L</b>		
2000; OE Type Thermostat .....	◆✂45948	180	1998-1996; Premium Thermostat .....	◆45028	180
	◆✂13947	170	1998-1996; OE Type Thermostat .....	◆14028	180
2000; OE Type Thermostat .....	◆✂13948	180	<b>V-6 3.1 L</b>		
1999; OE Exact Thermostat .....	◆✂48138	180	1998-1995; Premium Thermostat .....	◆○45899	195
1999; Premium Thermostat .....	◆✂45947	170	1998-1995; OE Type Thermostat .....	◆○13899	195
	◆✂45948	180	<b>Alero</b>		
1999; OE Type Thermostat .....	◆✂13947	170	<b>4-Cyl. 2.2 L</b>		
	◆✂13948	180	2004-2002; OE Exact Thermostat .....	◆○48628	180
<b>V-6 3.5 L</b>			2004-2002; OE Type Thermostat .....	◆○14698	180
2009-2004; Thermostat Water Outlet Assembly .....	◆14778	180	<b>Rogue</b>		
<b>Rogue</b>			<b>4-Cyl. 2.5 L</b>		
4-Cyl. 2.5 L			2011-2008; OE Type Thermostat - Lower .....	◆○14678	180
2011-2008; OE Type Thermostat - Lower .....	◆○14678	180			

◆ OE Temperature.  
 ✂ Alternate Temperature.

✂ Gasket Not Required. Use Silicone.  
 ○ Seal Included.

# Thermostats for Passenger Cars and Light Trucks (1990 and Newer)

Application	Part Number	Temp°F	Application	Part Number	Temp°F
<b>Oldsmobile - Continued</b>			<b>Oldsmobile - Continued</b>		
<b>Alero - Continued</b>			<b>Ninety Eight</b>		
4-Cyl. 2.4 L			V-6 3.8 L		
2001-1999; Premium Thermostat .....	◆45028	180	1996-1995; Premium Thermostat .....	◆45849	195
2001-1999; OE Type Thermostat .....	◆14028	180	◆45848	180	
V-6 3.4 L			1996-1995; OE Type Thermostat .....		
2004; Premium Thermostat .....	◆○45899	195	◆13849	195	
2004; OE Type Thermostat .....	◆○13899	195	◆13848	180	
2003-1999; OE Type Thermostat .....	◆○13899	195	<b>Regency</b>		
<b>Aurora</b>			V-6 3.8 L		
V-8 4.0 L			1998-1997; Premium Thermostat .....		
2003-2001; OE Type Thermostat .....	◆○14228	180	◆45849	195	
1999-1995; OE Type Thermostat .....	◆○14228	180	◆45848	180	
<b>Bravada</b>			1998-1997; OE Type Thermostat .....		
6-Cyl. 4.2 L			◆13849		
2004-2002; Thermostat Water Outlet Assembly .....	◆○14659	190	◆13848	180	
V-6 4.3 L			1998-1997; OE Type Thermostat .....		
2001-1996; Premium Thermostat .....	◆○45119	195	◆45849	195	
2001-1996; OE Type Thermostat .....	◆○14119	195	◆45848	180	
<b>Cutlass</b>			1995; OE Type Thermostat .....		
V-6 3.1 L			◆13849		
1999-1997; Premium Thermostat .....	◆○45899	195	◆13848	180	
1999-1997; OE Type Thermostat .....	◆○13899	195	<b>Silhouette</b>		
<b>Cutlass Ciera</b>			V-6 3.4 L		
4-Cyl. 2.2 L			2004-2001; OE Type Thermostat .....		
1996; Premium Thermostat .....	◆45849	195	◆○13899	195	
◆45848	180		2000; Premium Thermostat .....	◆○45899	195
1996; OE Type Thermostat .....	◆13849	195	2000; OE Type Thermostat .....	◆○13899	195
◆13848	180		1999; OE Type Thermostat .....	◆○13899	195
1995; Premium Thermostat .....	◆45028	180	1998-1996; Premium Thermostat .....	◆○45899	195
1995; OE Type Thermostat .....	◆14028	180	1998-1996; OE Type Thermostat .....	◆○13899	195
V-6 3.1 L			V-6 3.8 L		
1996-1995; Premium Thermostat .....	◆○45899	195	1995; Premium Thermostat .....		
1996-1995; OE Type Thermostat .....	◆○13899	195	◆45849		
<b>Cutlass Supreme</b>			◆45848		
V-6 3.1 L			1995; OE Type Thermostat .....		
1997-1995; Premium Thermostat .....	◆○45899	195	◆13849	195	
1997-1995; OE Type Thermostat .....	◆○13899	195	◆13848	180	
V-6 3.4 L			1995; OE Type Thermostat .....		
1996; Premium Thermostat .....	◆45849	195	◆13849	195	
◆45848	180		◆13848	180	
1996; OE Type Thermostat .....	◆13849	195	<b>Plymouth</b>		
◆13848	180		<b>Acclaim</b>		
1995; Premium Thermostat .....	◆○45899	195	4-Cyl. 2.5 L		
1995; OE Type Thermostat .....	◆○13899	195	1995; Premium Thermostat .....		
<b>Eighty Eight</b>			◆45789		
V-6 3.8 L			◆45788		
1999-1995; Premium Thermostat .....	◆45849	195	◆13789		
◆45848	180		◆13788		
1999-1995; OE Type Thermostat .....	◆13849	195	1995; OE Type Thermostat .....		
◆13848	180		◆45869		
<b>Intrigue</b>			◆45868		
V-6 3.5 L			1995; OE Type Thermostat .....		
2002-1999; Thermostat Water Outlet Assembly .....	◆○14798	180	◆13869	195	
V-6 3.8 L			◆13868	180	
1999-1998; Premium Thermostat .....	◆45849	195	<b>Breeze</b>		
◆45848	180		4-Cyl. 2.0 L		
1999-1998; OE Type Thermostat .....	◆13849	195	2000-1996; Premium Thermostat .....		
◆13848	180		◆45209		
<b>LSS</b>			2000-1996; OE Type Thermostat .....		
V-6 3.8 L			◆14209		
1999-1997; Premium Thermostat .....	◆45849	195	4-Cyl. 2.4 L		
◆45848	180		2000-1997; Premium Thermostat .....		
1999-1997; OE Type Thermostat .....	◆13849	195	◆45209		
◆13848	180		2000-1997; OE Type Thermostat .....		
<b>Grand Voyager</b>			◆14209		
4-Cyl. 2.4 L			1997-1996; Premium Thermostat .....		
1997-1996; Premium Thermostat .....	◆45209	195	◆45209		
1997-1996; OE Type Thermostat .....	◆14209	195	2000-1995; Premium Thermostat .....		
V-6 3.0 L			◆45869		
2000-1995; Premium Thermostat .....	◆45869	195	◆45868		
◆45868	180		2000-1995; OE Type Thermostat .....		
2000-1995; OE Type Thermostat .....	◆13869	195	◆13868		
V-6 3.3 L			1999; Premium Thermostat .....		
2000-1995; Premium Thermostat .....	◆45209	195	◆14209		
2000-1995; OE Type Thermostat .....	◆14209	195	1999; OE Type Thermostat .....		
V-6 3.8 L			◆45209		
1999; Premium Thermostat .....	◆45209	195	◆45209		
1999; OE Type Thermostat .....	◆14209	195	1995; Premium Thermostat .....		
1995; Premium Thermostat .....	◆45209	195	◆14209		
1995; OE Type Thermostat .....	◆14209	195	1995; OE Type Thermostat .....		
V-6 3.8 L (Canada)			◆45869		
1998; Premium Thermostat .....	◆45209	195	◆45868		
1998; OE Type Thermostat .....	◆14209	195			
1997; Premium Thermostat .....	◆45869	195			
◆45868	180				

◆ OE Temperature.  
 ◆ Alternate Temperature.

○ Seal Included.

# Thermostats for Passenger Cars and Light Trucks (1990 and Newer)

Application	Part Number	Temp°F	Application	Part Number	Temp°F
<b>Plymouth - Continued</b>			<b>Pontiac - Continued</b>		
<b>Grand Voyager - Continued</b>			<b>Firebird - Continued</b>		
<b>V-6 3.8 L (Canada) - Continued</b>			<b>V-8 5.7 L - Continued</b>		
1997; OE Type Thermostat .....	◆13869	195	2002-1998; Heavy-Duty Thermostat; W/GM Replacement Water Pump .....	◆○14948	186
	◇13868	180	1997-1995; Premium Thermostat .....	◆○45218	180
<b>Neon</b>			1997-1995; OE Type Thermostat .....		
<b>4-Cyl. 2.0 L</b>			◆○14218		
2001-1995; Premium Thermostat .....	◆45209	195	<b>Firefly</b>		
2001-1995; OE Type Thermostat .....	◆14209	195	<b>3-Cyl. 1.0 L (Canada)</b>		
<b>Prowler</b>			2000-1997; Premium Thermostat .....		
<b>V-6 3.5 L</b>			◆45849		
2001-1999; OE Type Thermostat .....	◆14358	180	◇45848		
1997; Premium Thermostat .....	◆45209	195	◆13849		
1997; OE Type Thermostat .....	◆14209	195	◇13848		
<b>Voyager</b>			1996-1995; Premium Thermostat .....		
<b>4-Cyl. 2.4 L</b>			◇45849		
2000-1996; Premium Thermostat .....	◆45209	195	◇45848		
2000-1996; OE Type Thermostat .....	◆14209	195	◆13849		
<b>4-Cyl. 2.5 L</b>			1996-1995; OE Type Thermostat .....		
1995; Premium Thermostat .....	◆45789	195	◆45849		
	◇45788	180	◇45848		
	◆13789	195	◆13849		
	◇13788	180	◇13848		
<b>V-6 3.0 L</b>			<b>4-Cyl. 1.3 L (Canada)</b>		
2000-1995; Premium Thermostat .....	◆45869	195	2000-1995; Premium Thermostat .....		
	◇45868	180	◆45849		
2000-1995; OE Type Thermostat .....	◆13869	195	◇45848		
	◇13868	180	◆13849		
<b>V-6 3.3 L</b>			◇13848		
2000-1995; Premium Thermostat .....	◆45209	195	<b>G5</b>		
2000-1995; OE Type Thermostat .....	◆14209	195	<b>4-Cyl. 2.2 L</b>		
<b>V-6 3.8 L</b>			2009-2007; OE Exact Thermostat .....		
1999; Premium Thermostat .....	◆45209	195	◆○48628		
1999; OE Type Thermostat .....	◆14209	195	2009-2007; OE Type Thermostat .....		
1996; Premium Thermostat .....	◆45209	195	◆○14698		
1996; OE Type Thermostat .....	◆14209	195	<b>4-Cyl. 2.4 L</b>		
<b>V-6 3.8 L (Canada)</b>			2008-2007; OE Exact Thermostat .....		
1998-1997; Premium Thermostat .....	◆45209	195	◆○48628		
1998-1997; OE Type Thermostat .....	◆14209	195	2008-2007; OE Type Thermostat .....		
<b>Pontiac</b>			◆○14698		
<b>Aztek</b>			<b>G6</b>		
<b>V-6 3.4 L</b>			<b>4-Cyl. 2.4 L</b>		
2005-2002; OE Type Thermostat .....	◆○13899	195	2010-2006; OE Exact Thermostat .....		
2001; Premium Thermostat .....	◆○45899	195	2010-2006; OE Type Thermostat .....		
2001; OE Type Thermostat .....	◆○13899	195	◆○48628		
<b>Bonneville</b>			◆○14698		
<b>V-6 3.8 L</b>			<b>V-6 3.5 L</b>		
2005-1995; Premium Thermostat .....	◆45849	195	2010-2007; OE Exact Thermostat .....		
	◇45848	180	◆○48808		
2005-1995; OE Type Thermostat .....	◆13849	195	2006; OE Exact Thermostat .....		
	◇13848	180	◆○48808		
<b>V-8 4.6 L</b>			2006; OE Type Thermostat .....		
2005-2004; OE Type Thermostat .....	◆○14228	180	◆○13899		
<b>Firebird</b>			2005; Premium Thermostat .....		
<b>V-6 3.4 L</b>			2005; OE Type Thermostat .....		
1995; Premium Thermostat .....	◆45849	195	◆○48808		
	◇45848	180	◆○48808		
1995; OE Type Thermostat .....	◆13849	195	◆○13899		
	◇13848	180	◆○45899		
<b>V-6 3.8 L</b>			◆○13899		
2002-1995; Premium Thermostat .....	◆45849	195	<b>V-6 3.9 L</b>		
	◇45848	180	2010-2006; OE Exact Thermostat .....		
2002-1995; OE Type Thermostat .....	◆13849	195	◆○48808		
	◇13848	180	<b>G8</b>		
<b>V-8 5.7 L</b>			<b>V-8 6.0 L</b>		
2002-1998; Thermostat Water Outlet Assembly; W/OE or Most Aftermarket Water Pumps .....	◆○14298	186	2009-2008; Heavy-Duty Thermostat .....		
			◆○14948		
			<b>Grand Am</b>		
			<b>4-Cyl. 2.2 L</b>		
			2005-2002; OE Exact Thermostat .....		
			◆○48628		
			2005-2002; OE Type Thermostat .....		
			◆○14698		
			<b>4-Cyl. 2.3 L</b>		
			1995; Premium Thermostat .....		
			◆45028		
			1995; OE Type Thermostat .....		
			◆14028		
			<b>4-Cyl. 2.4 L</b>		
			2001-1996; Premium Thermostat .....		
			◆45028		
			2001-1996; OE Type Thermostat .....		
			◆14028		
			<b>V-6 3.1 L</b>		
			1998-1995; Premium Thermostat .....		
			◆○45899		
			1998-1995; OE Type Thermostat .....		
			◆○13899		
			<b>V-6 3.4 L</b>		
			2005-1999; Premium Thermostat .....		
			◆○45899		
			2005-1999; OE Type Thermostat .....		
			◆○13899		
			<b>Grand Prix</b>		
			<b>V-6 3.1 L</b>		
			2003-1996; Premium Thermostat .....		
			◆○45899		
			2003-1996; OE Type Thermostat .....		
			◆○13899		
			1995; OE Type Thermostat .....		
			◆○13899		

◆ OE Temperature.  
○ Seal Included.

◇ Alternate Temperature.

# Thermostats for Passenger Cars and Light Trucks (1990 and Newer)

Application	Part Number	Temp°F	Application	Part Number	Temp°F
<b>Pontiac - Continued</b>			<b>Pontiac - Continued</b>		
<b>Grand Prix - Continued</b>			<b>Sunrunner</b>		
<b>V-6 3.4 L</b>			<b>4-Cyl. 1.6 L (Canada)</b>		
1996; Premium Thermostat .....	◆45849	195	1997-1995; OE Exact Thermostat .....	◆○48028	180
	◆45848	180	1997-1995; OE Type Thermostat .....	◆13958	180
1996; OE Type Thermostat .....	◆13849	195		◆13959	195
	◆13848	180	1997-1995; OE Exact Thermostat .....	◆○48028	180
1995; Premium Thermostat .....	◆○45899	195	1997-1995; OE Type Thermostat .....	◆13958	180
1995; OE Type Thermostat .....	◆○13899	195		◆13959	195
<b>V-6 3.8 L</b>			<b>Torrent</b>		
2008; Premium Thermostat .....	◆45849	195	<b>V-6 3.4 L</b>		
2008; OE Type Thermostat .....	◆13849	195	2009-2006; OE Type Thermostat .....	◆○13899	195
2007-1997; Premium Thermostat .....	◆45849	195	<b>Trans Sport</b>		
	◆45848	180	<b>V-6 3.1 L</b>		
2007-1997; OE Type Thermostat .....	◆13849	195	1995; Premium Thermostat .....	◆○45899	195
	◆13848	180	1995; OE Type Thermostat .....	◆○13899	195
<b>V-8 5.3 L</b>			<b>V-6 3.4 L</b>		
2008-2005; Heavy-Duty Thermostat .....	◆○14948	186	1998-1996; Premium Thermostat .....	◆○45899	195
<b>GTO</b>			1998-1996; OE Type Thermostat .....	◆○13899	195
<b>V-8 5.7 L</b>			<b>V-6 3.8 L</b>		
2004; Heavy-Duty Thermostat .....	◆○14948	186	1995; Premium Thermostat .....	◆45849	195
<b>V-8 6.0 L</b>				◆45848	180
2006-2005; Heavy-Duty Thermostat .....	◆○14948	186	1995; OE Type Thermostat .....	◆13849	195
<b>Montana</b>				◆13848	180
<b>V-6 3.4 L</b>			<b>Vibe</b>		
2005-1999; OE Type Thermostat .....	◆○13899	195	<b>4-Cyl. 1.8 L</b>		
<b>V-6 3.5 L</b>			2007-2004; OE Type Thermostat .....	◆14078	180
2006-2005; Premium Thermostat .....	◆○45899	195		◆14077	170
2006-2005; OE Type Thermostat .....	◆○13899	195	2003; OE Exact Thermostat .....	◆48128	180
<b>V-6 3.9 L</b>			2003; OE Type Thermostat .....	◆14078	180
2006; OE Exact Thermostat .....	◆○48808	185		◆14077	170
<b>V-6 3.9 L (Canada)</b>			<b>Porsche</b>		
2008-2007; OE Exact Thermostat .....	◆○48808	185	<b>911</b>		
<b>Pursuit</b>			<b>6-Cyl. 3.4 L</b>		
<b>4-Cyl. 2.2 L (Canada)</b>			2001-1999; OE Type Thermostat .....	◆14768	180
2006; OE Type Thermostat .....	◆○14698	180	<b>6-Cyl. 3.6 L</b>		
2005; OE Exact Thermostat .....	◆○48628	180	2008-2002; OE Type Thermostat .....	◆14768	180
2005; OE Type Thermostat .....	◆○14698	180	1998; OE Type Thermostat .....	◆14768	180
<b>4-Cyl. 2.4 L (Canada)</b>			<b>6-Cyl. 3.8 L</b>		
2006; OE Type Thermostat .....	◆○14698	180	2008-2005; OE Type Thermostat .....	◆14768	180
<b>Solstice</b>			<b>928</b>		
<b>4-Cyl. 2.0 L</b>			<b>V-8 5.4 L</b>		
2010-2007; OE Exact Thermostat .....	◆○48628	180	1995; OE Type Thermostat .....	◆13648	180
2010-2007; OE Type Thermostat .....	◆○14698	180		◆13649	190
<b>4-Cyl. 2.4 L</b>			<b>968</b>		
2009-2006; OE Exact Thermostat .....	◆○48628	180	<b>4-Cyl. 3.0 L</b>		
2009-2006; OE Type Thermostat .....	◆○14698	180	1995; Premium Thermostat .....	◆45378	180
<b>Sunfire</b>				◆45379	195
<b>4-Cyl. 2.2 L</b>				◆13378	180
2005-2004; OE Exact Thermostat .....	◆○48628	180		◆13379	195
2005-2004; OE Type Thermostat .....	◆○14698	180		◆13376	160
2003; OE Type Thermostat .....	◆○14698	180	<b>Boxster</b>		
2002; Premium Thermostat; Eng. VIN 4 .....	◆45028	180	<b>6-Cyl. 2.5 L</b>		
2002; OE Type Thermostat; Eng. VIN 4 .....	◆14028	180	1999-1997; OE Type Thermostat .....	◆14768	180
2002; OE Type Thermostat; Eng. VIN F .....	◆○14698	180	<b>6-Cyl. 2.7 L</b>		
2001-1996; Premium Thermostat .....	◆45028	180	2009-2000; OE Type Thermostat .....	◆14768	180
2001-1996; OE Type Thermostat .....	◆14028	180	<b>6-Cyl. 3.2 L</b>		
1995; Premium Thermostat .....	◆45849	195	2006-2000; OE Type Thermostat .....	◆14768	180
	◆45848	180	<b>6-Cyl. 3.4 L</b>		
1995; OE Type Thermostat .....	◆13849	195	2008-2007; OE Type Thermostat .....	◆14768	180
	◆13848	180	<b>Cayman</b>		
<b>4-Cyl. 2.3 L</b>			<b>6-Cyl. 2.7 L</b>		
1995; Premium Thermostat .....	◆45028	180	2009-2007; OE Type Thermostat .....	◆14768	180
1995; OE Type Thermostat .....	◆14028	180	<b>6-Cyl. 3.4 L</b>		
<b>4-Cyl. 2.4 L</b>			2008-2006; OE Type Thermostat .....	◆14768	180
2002-1996; Premium Thermostat .....	◆45028	180			
2002-1996; OE Type Thermostat .....	◆14028	180			

◆ OE Temperature.  
○ Seal Included.

◆ Alternate Temperature.

## Thermostats for Passenger Cars and Light Trucks (1990 and Newer)

Application	Part Number	Temp°F	Application	Part Number	Temp°F
<b>Saab</b>			<b>Saturn - Continued</b>		
<b>9-2X</b>			<b>Aura - Continued</b>		
4-Cyl. 2.0 L			4-Cyl. 2.4 L Electric Assist		
2005; OE Exact Thermostat .....	◆○48457	170	2009-2007; OE Exact Thermostat .....	◆○48628	180
4-Cyl. 2.5 L			2009-2007; OE Type Thermostat .....	◆○14698	180
2006-2005; OE Exact Thermostat .....	◆○48457	170	V-6 3.5 L		
<b>9-3</b>			2008-2007; OE Exact Thermostat .....	◆○48808	185
4-Cyl. 2.0 L			<b>Ion</b>		
2009; OE Exact Thermostat .....	◆○48628	180	4-Cyl. 2.0 L		
2009; OE Type Thermostat .....	◆○14698	180	2007-2004; OE Type Thermostat .....	◆○14698	180
2007-2005; OE Type Thermostat .....	◆○14698	180	4-Cyl. 2.2 L		
2004-1999; Premium Thermostat .....	◆45399	195	2007-2005; OE Exact Thermostat .....	◆○48628	180
	◆45398	180	2007-2005; OE Type Thermostat .....	◆○14698	180
2004-1999; OE Type Thermostat .....	◆13399	195	2004-2003; OE Type Thermostat .....	◆○14698	180
	◆13398	180	4-Cyl. 2.4 L		
4-Cyl. 2.3 L			2007; OE Exact Thermostat .....	◆○48628	180
2002-1999; Premium Thermostat .....	◆45399	195	2007; OE Type Thermostat .....	◆○14698	180
	◆45398	180	2006; OE Type Thermostat .....	◆○14698	180
2002-1999; OE Type Thermostat .....	◆13399	195	2006; OE Exact Thermostat .....	◆○48628	180
	◆13398	180	<b>L-Series</b>		
<b>9-5</b>			4-Cyl. 2.2 L		
4-Cyl. 2.3 L			2004-2000; OE Exact Thermostat .....	◆○48628	180
2008-2000; OE Exact Thermostat .....	◆○48349	192	2004-2000; OE Type Thermostat .....	◆○14698	180
2008-2000; Premium Thermostat .....	◆45399	195	V-6 3.0 L		
	◆45398	180	2005-2000; OE Exact Thermostat Valve Motor & Spring		
2008-2000; OE Type Thermostat .....	◆13399	195	Assembly; W/O Early GM Housing .....	◆48759	198
	◆13398	180	2005-2000; Thermostat Water Outlet Assembly; W/Early		
1999; Premium Thermostat .....	◆45399	195	GM Housing .....	◆○14309	195
	◆45398	180	<b>Relay</b>		
1999; OE Type Thermostat .....	◆13399	195	V-6 3.5 L		
	◆13398	180	2006-2005; Premium Thermostat .....	◆○45899	195
V-6 3.0 L			2006-2005; OE Type Thermostat .....	◆○13899	195
2003-1999; Premium Thermostat .....	◆45399	195	V-6 3.9 L		
	◆45398	180	2007-2006; OE Exact Thermostat .....	◆○48808	185
2003-1999; OE Type Thermostat .....	◆13399	195	<b>S-Series</b>		
	◆13398	180	4-Cyl. 1.9 L		
<b>9-7X</b>			2002-1995; OE Type Thermostat .....	◆○14279	188
6-Cyl. 4.2 L			<b>Sky</b>		
2009; Thermostat Water Outlet Assembly .....	◆○14659	190	4-Cyl. 2.0 L; 4-Cyl. 2.4 L		
2007; Thermostat Water Outlet Assembly .....	◆○14659	190	2009-2007; OE Exact Thermostat .....	◆○48628	180
V-8 5.3 L			2009-2007; OE Type Thermostat .....	◆○14698	180
2009-2008; Heavy-Duty Thermostat .....	◆○14948	186	<b>VUE</b>		
2006; Heavy-Duty Thermostat .....	◆○14948	186	4-Cyl. 2.2 L		
V-8 6.0 L			2007-2002; OE Exact Thermostat .....	◆○48628	180
2009-2008; Heavy-Duty Thermostat .....	◆○14948	186	2007-2002; OE Type Thermostat .....	◆○14698	180
<b>900</b>			4-Cyl. 2.4 L		
4-Cyl. 2.0 L; 4-Cyl. 2.3 L			2009-2008; OE Exact Thermostat .....	◆○48628	180
1998-1995; Premium Thermostat .....	◆45399	195	2009-2008; OE Type Thermostat .....	◆○14698	180
	◆45398	180	4-Cyl. 2.4 L Electric Assist		
1998-1995; OE Type Thermostat .....	◆13399	195	2009-2007; OE Exact Thermostat .....	◆○48628	180
	◆13398	180	2009-2007; OE Type Thermostat .....	◆○14698	180
V-6 2.5 L			V-6 3.0 L		
1996-1995; OE Type Thermostat .....	◆○14279	188	2003-2002; OE Exact Thermostat Valve Motor & Spring		
<b>9000</b>			Assembly; W/O Early GM Housing .....	◆48759	198
4-Cyl. 2.3 L			2003-2002; Thermostat Water Outlet Assembly; W/Early		
1998-1995; Premium Thermostat .....	◆45399	195	GM Housing .....	◆○14309	195
	◆45398	180	V-6 3.5 L		
1998-1995; OE Type Thermostat .....	◆13399	195	2009-2008; OE Exact Thermostat .....	◆○48808	185
	◆13398	180	<b>Scion</b>		
V-6 3.0 L			<b>TC</b>		
1997-1995; OE Type Thermostat .....	◆○14279	188	4-Cyl. 2.4 L		
<b>Saturn</b>			2010; OE Type Thermostat .....	◆14078	180
<b>Aura</b>			2009-2005; OE Exact Thermostat .....	◆48128	180
4-Cyl. 2.4 L			2009-2005; OE Type Thermostat .....	◆14078	180
2010-2008; OE Exact Thermostat .....	◆○48628	180		◆14077	170
2010-2008; OE Type Thermostat .....	◆○14698	180			

◆ OE Temperature.  
 ◆ Alternate Temperature.

○ Seal Included.

# Thermostats for Passenger Cars and Light Trucks (1990 and Newer)

Application	Part Number	Temp°F	Application	Part Number	Temp°F
<b>Scion - Continued</b>			<b>Subaru - Continued</b>		
<b>TC - Continued</b>			<b>Legacy - Continued</b>		
4-Cyl. 2.5 L			4-Cyl. 2.5 L		
2012-2011: OE Type Thermostat .....	◆14078	180	2008-2005: OE Type Thermostat .....	◆14147	170
2012-2011: OE Exact Thermostat .....	◆48128	180	2004-1996: OE Exact Thermostat .....	◆○48457	170
2004-1996: OE Type Thermostat .....	◆14147	170	2004-1996: OE Type Thermostat .....	◆14147	170
<b>XA</b>			<b>Outback</b>		
4-Cyl. 1.5 L			4-Cyl. 2.5 L		
2006-2004: OE Exact Thermostat .....	◆48308	180	2008-2005: OE Type Thermostat .....	◆14147	170
2006-2004: OE Type Thermostat .....	◆14108	180	2004-2000: OE Exact Thermostat .....	◆○48457	170
<b>XB</b>			2004-2000: OE Type Thermostat .....	◆14147	170
4-Cyl. 1.5 L			6-Cyl. 3.0 L		
2006-2004: OE Exact Thermostat .....	◆48308	180	2008-2006: OE Type Thermostat .....	◆14147	170
2006-2004: OE Type Thermostat .....	◆14108	180	2005; Premium Thermostat .....	◆45859	195
<b>XD</b>			2005; OE Type Thermostat .....	◆13859	195
4-Cyl. 1.8 L			2005; OE Type Thermostat .....	◆13858	180
2010: OE Type Thermostat .....	◆14078	180	2004-2001: OE Exact Thermostat .....	◆○48457	170
2009: OE Exact Thermostat .....	◆48128	180	2004-2001: OE Type Thermostat .....	◆14147	170
2009: OE Type Thermostat .....	◆14078	180	<b>SVX</b>		
2008: OE Exact Thermostat .....	◆48128	180	6-Cyl. 3.3 L		
2008: OE Type Thermostat .....	◆14078	180	1997-1995: OE Exact Thermostat .....	◆○48457	170
2007: OE Type Thermostat .....	◆14077	170	1997-1995: OE Type Thermostat .....	◆14147	170
<b>Subaru</b>			<b>Suzuki</b>		
<b>B9 Tribeca</b>			<b>Aerio</b>		
6-Cyl. 3.0 L			4-Cyl. 2.0 L		
2007-2006: Premium Thermostat .....	◆45859	195	2003-2002: OE Type Thermostat .....	◆14378	180
2007-2006: OE Type Thermostat .....	◆45858	180	4-Cyl. 2.3 L		
2007-2006: OE Type Thermostat .....	◆13859	195	2007-2004: OE Type Thermostat .....	◆14378	180
2007-2006: OE Type Thermostat .....	◆13858	180	<b>Esteem</b>		
<b>Baja</b>			4-Cyl. 1.6 L		
4-Cyl. 2.5 L			2000-1995: OE Exact Thermostat .....	◆○48529	190
2006-2003: OE Exact Thermostat .....	◆○48457	170	2000-1995: Premium Thermostat .....	◆45849	195
2006-2003: OE Type Thermostat .....	◆14147	170	2000-1995: OE Type Thermostat .....	◆45848	180
<b>Forester</b>			2000-1995: OE Type Thermostat .....	◆13849	195
4-Cyl. 2.5 L			2000-1995: OE Type Thermostat .....	◆13848	180
2010-1998: OE Exact Thermostat .....	◆○48457	170	4-Cyl. 1.8 L		
2010-1998: OE Type Thermostat .....	◆14147	170	2002-2000: OE Type Thermostat .....	◆14378	180
<b>Impreza</b>			1999: OE Exact Thermostat .....	◆○48529	190
4-Cyl. 1.8 L			1999; Premium Thermostat .....	◆45849	195
1997-1995: OE Exact Thermostat .....	◆○48457	170	1999; OE Type Thermostat .....	◆45848	180
1997-1995: OE Type Thermostat .....	◆14147	170	1999; OE Type Thermostat .....	◆13849	195
4-Cyl. 2.0 L			1999; OE Type Thermostat .....	◆13848	180
2005-2002: OE Exact Thermostat .....	◆○48457	170	<b>Grand Vitara</b>		
2005-2002: OE Type Thermostat .....	◆14147	170	V-6 2.5 L		
4-Cyl. 2.2 L			2005-1999: OE Type Thermostat .....		
2001-1995: OE Exact Thermostat .....	◆○48457	170	2005-1999: OE Type Thermostat .....	◆14048	180
2001-1995: OE Type Thermostat .....	◆14147	170	V-6 2.7 L		
4-Cyl. 2.5 L			2008-2006: OE Type Thermostat .....		
2010-1998: OE Exact Thermostat .....	◆○48457	170	2008-2006: OE Type Thermostat .....	◆14048	180
2010-1998: OE Type Thermostat .....	◆14147	170	<b>Samurai</b>		
<b>Justy</b>			4-Cyl. 1.3 L		
3-Cyl. 1.2 L (Canada)			1995: OE Exact Thermostat .....	◆○48028	180
1995: OE Exact Thermostat .....	◆○48597	170	1995: OE Type Thermostat .....	◆13958	180
1995: OE Type Thermostat .....	◆14157	170	1995: OE Type Thermostat .....	◆13959	195
<b>Legacy</b>			<b>Sidekick</b>		
4-Cyl. 2.2 L			4-Cyl. 1.6 L		
1999-1995: OE Exact Thermostat .....	◆○48457	170	1998-1995: OE Exact Thermostat .....	◆○48028	180
1999-1995: OE Type Thermostat .....	◆14147	170	1998-1995: OE Type Thermostat .....	◆13958	180
<b>Subaru</b>			4-Cyl. 1.8 L		
<b>Legacy</b>			1998-1996: OE Type Thermostat .....	◆14378	180
4-Cyl. 1.3 L			<b>Swift</b>		
2001-1995: OE Exact Thermostat .....	◆○48529	190	4-Cyl. 1.3 L		
2001-1995: Premium Thermostat .....	◆45849	195	2001-1995: OE Exact Thermostat .....	◆○48529	190
2001-1995: OE Type Thermostat .....	◆45848	180	2001-1995: Premium Thermostat .....	◆45849	195
2001-1995: OE Type Thermostat .....	◆13849	195	2001-1995: OE Type Thermostat .....	◆13849	195
2001-1995: OE Type Thermostat .....	◆13848	180	2001-1995: OE Type Thermostat .....	◆13848	180

◆ OE Temperature.  
○ Seal Included.

◆ Alternate Temperature.

## Thermostats for Passenger Cars and Light Trucks (1990 and Newer)

Application	Part Number	Temp°F	Application	Part Number	Temp°F
<b>Suzuki - Continued</b>			<b>Toyota - Continued</b>		
<b>SX4</b>			<b>Camry - Continued</b>		
4-Cyl. 2.0 L 2009-2007; OE Type Thermostat .....	◆14378	180	4-Cyl. 2.4 L Electric Assist - Continued		
<b>Vitara</b>			2011; OE Type Thermostat .....	◆14078	180
4-Cyl. 2.0 L 2003-1999; OE Type Thermostat .....	◆14378	180	2010; OE Type Thermostat .....	◆14078	180
V-6 2.5 L 2004; OE Type Thermostat .....	◆14048	180	2009-2007; OE Exact Thermostat .....	◆48128	180
<b>X-90</b>			2009-2007; OE Type Thermostat .....	◆14078	180
4-Cyl. 1.6 L			◆14077	170	
1998-1996; OE Exact Thermostat .....	◆○48028	180	<b>4-Cyl. 2.5 L</b>		
1998-1996; OE Type Thermostat .....	◆13958	180	2011-2010; OE Exact Thermostat .....	◆48128	180
	◆13959	195	2011-2010; OE Type Thermostat .....	◆14078	180
<b>XL-7</b>			<b>V-6 3.0 L</b>		
V-6 2.7 L 2006-2002; OE Type Thermostat .....	◆14048	180	2006-1995; OE Exact Thermostat .....	◆48128	180
<b>Toyota</b>			2006-1995; OE Type Thermostat .....	◆14078	180
<b>4 Runner</b>			◆14077	170	
4-Cyl. 2.4 L			<b>V-6 3.3 L</b>		
1995; OE Exact Thermostat .....	◆48319	190	2006; OE Exact Thermostat .....	◆48128	180
1995; Premium Thermostat .....	◆45869	195	2006; OE Type Thermostat .....	◆14078	180
	◆45868	180	◆14077	170	
1995; OE Type Thermostat .....	◆13869	195	2005; OE Type Thermostat .....	◆14078	180
	◆13868	180	◆14077	170	
<b>4-Cyl. 2.7 L</b>			2004; OE Exact Thermostat .....	◆48128	180
2010; OE Exact Thermostat Water Outlet Assembly .....	◆○48778	180	2004; OE Type Thermostat .....	◆14078	180
2000-1996; OE Exact Thermostat .....	◆○48418	180	◆14077	170	
2000-1996; OE Type Thermostat .....	◆14108	180	<b>V-6 3.5 L</b>		
<b>V-6 3.0 L</b>			2011; OE Exact Thermostat .....	◆48128	180
1995; OE Exact Thermostat .....	◆48288	180	2011; OE Type Thermostat .....	◆14078	180
1995; Premium Thermostat .....	◆45978	180	2010; OE Type Thermostat .....	◆14078	180
	◆45979	195	2009; OE Exact Thermostat .....	◆48128	180
1995; OE Type Thermostat .....	◆13978	180	2009; OE Type Thermostat .....	◆14078	180
	◆13979	195	◆14077	170	
<b>V-6 3.4 L</b>			2008-2007; OE Type Thermostat; Models made in Japan .....	◆14078	180
2002-1996; OE Exact Thermostat .....	◆48118	180	◆14077	170	
2002-1996; OE Type Thermostat .....	◆14078	180	<b>Camry Solara</b>		
	◆14077	170	<b>4-Cyl. 2.2 L</b>		
<b>V-6 4.0 L</b>			2000-1999; OE Exact Thermostat .....	◆48278	180
2011-2003; OE Exact Thermostat Water Outlet Assembly .....	◆○48778	180	2000-1999; Premium Thermostat .....	◆45758	180
<b>V-8 4.7 L</b>			2000-1999; OE Type Thermostat .....	◆13758	180
2009-2003; OE Type Thermostat .....	◆14128	180	<b>V-6 3.0 L</b>		
	◆14127	170	2000; OE Exact Thermostat .....	◆48128	180
<b>Avalon</b>			2000; OE Type Thermostat .....	◆14078	180
V-6 3.0 L			◆14077	170	
2004-1995; OE Exact Thermostat .....	◆48128	180	1999; OE Type Thermostat .....		
2004-1995; OE Type Thermostat .....	◆14078	180	◆14077	170	
	◆14077	170	<b>Celica</b>		
<b>V-6 3.5 L</b>			<b>4-Cyl. 1.8 L</b>		
2011; OE Type Thermostat .....	◆14078	180	2005-2000; OE Exact Thermostat .....	◆48128	180
2009-2006; OE Type Thermostat; Models made in USA.	◆14078	180	2005-2000; OE Type Thermostat .....	◆14078	180
	◆14077	170	◆14077	170	
2005; OE Type Thermostat .....	◆14078	180	1997-1995; OE Exact Thermostat .....	◆48148	180
	◆14077	170	1997-1995; Premium Thermostat .....	◆45758	180
<b>Camry</b>			1997-1995; OE Type Thermostat .....	◆13758	180
4-Cyl. 2.2 L			<b>4-Cyl. 2.2 L</b>		
2001-1995; OE Exact Thermostat .....	◆48278	180	1999-1997; OE Exact Thermostat .....	◆48278	180
2001-1995; Premium Thermostat .....	◆45758	180	1999-1997; Premium Thermostat .....	◆45758	180
2001-1995; OE Type Thermostat .....	◆13758	180	1999-1997; OE Type Thermostat .....	◆13758	180
<b>4-Cyl. 2.4 L</b>			1996-1995; OE Exact Thermostat .....	◆48148	180
2009-2002; OE Exact Thermostat .....	◆48128	180	1996-1995; Premium Thermostat .....	◆45758	180
2009-2002; OE Type Thermostat .....	◆14078	180	1996-1995; OE Type Thermostat .....	◆13758	180
	◆14077	170	<b>Corolla</b>		
<b>4-Cyl. 2.4 L Electric Assist</b>			<b>4-Cyl. 1.6 L</b>		
2011; OE Exact Thermostat .....	◆48128	180	1997-1995; OE Exact Thermostat .....	◆48148	180
			1997-1995; Premium Thermostat .....	◆45758	180
			1997-1995; OE Type Thermostat .....	◆13758	180
			<b>4-Cyl. 1.8 L</b>		
			2011; OE Type Thermostat .....	◆14078	180
			2010-2000; OE Exact Thermostat .....	◆48128	180
			2010-2000; OE Type Thermostat .....	◆14078	180
			◆14077	170	
			1999-1998; OE Exact Thermostat .....	◆○48327	170

◆ OE Temperature.  
◆ Alternate Temperature.

○ Seal Included.

## Thermostats for Passenger Cars and Light Trucks (1990 and Newer)

Application	Part Number	Temp°F	Application	Part Number	Temp°F
<b>Toyota - Continued</b>			<b>Toyota - Continued</b>		
<b>Corolla - Continued</b>			<b>Matrix - Continued</b>		
<b>4-Cyl. 1.8 L - Continued</b>			<b>4-Cyl. 2.4 L</b>		
1999-1998; OE Type Thermostat .....	◆14077	170	2011; OE Type Thermostat .....	◆14078	180
	◇14078	180	2011; OE Exact Thermostat .....	◆48128	180
1997-1995; OE Exact Thermostat .....	◆48148	180	2010; OE Type Thermostat .....	◆14078	180
1997-1995; Premium Thermostat .....	◆45758	180	2009; OE Exact Thermostat .....	◆48128	180
1997-1995; OE Type Thermostat .....	◆13758	180	2009; OE Type Thermostat .....	◆14078	180
				◇14177	170
<b>4-Cyl. 2.4 L</b>			<b>MR2</b>		
2010; OE Type Thermostat .....	◆14078	180	<b>4-Cyl. 2.0 L; 4-Cyl. 2.2 L</b>		
2009; OE Exact Thermostat .....	◆48128	180	1995; OE Exact Thermostat .....	◆48148	180
2009; OE Type Thermostat .....	◆14078	180	1995; Premium Thermostat .....	◆45758	180
	◇14077	170	1995; OE Type Thermostat .....	◆13758	180
<b>Echo</b>			<b>MR2 Spyder</b>		
<b>4-Cyl. 1.5 L</b>			<b>4-Cyl. 1.8 L</b>		
2005-2000; OE Exact Thermostat .....	◆48308	180	2005; OE Exact Thermostat .....	◆48308	180
2005-2000; OE Type Thermostat .....	◆14108	180	2005; OE Type Thermostat .....	◆14078	180
<b>FJ Cruiser</b>				◇14077	170
<b>V-6 4.0 L</b>			2004; OE Exact Thermostat .....	◆48418	180
2011-2007; OE Exact Thermostat Water Outlet			2004; OE Type Thermostat .....	◆14078	180
Assembly .....	◆○48778	180		◇14077	170
<b>Highlander</b>				◆48128	180
<b>4-Cyl. 2.4 L</b>			2003-2001; OE Exact Thermostat .....	◆48128	180
2007-2001; OE Exact Thermostat .....	◆48128	180	2003-2001; OE Type Thermostat .....	◆14078	180
2007-2001; OE Type Thermostat .....	◆14078	180		◇14077	170
	◇14077	170		◆14078	180
<b>4-Cyl. 2.7 L</b>			2000; OE Type Thermostat .....	◆14078	180
2011; OE Type Thermostat .....	◆14078	180		◇14077	170
2011; OE Exact Thermostat .....	◆48128	180	<b>Paseo</b>		
2010-2009; OE Exact Thermostat .....	◆48128	180	<b>4-Cyl. 1.5 L</b>		
2010-2009; OE Type Thermostat .....	◆14078	180	1997-1995; OE Exact Thermostat .....	◆48148	180
	◇14077	170	1997-1995; Premium Thermostat .....	◆45758	180
<b>V-6 3.0 L</b>			1997-1995; OE Type Thermostat .....	◆13758	180
2003-2001; OE Exact Thermostat .....	◆48128	180	<b>4-Cyl. 1.5 L (Canada)</b>		
2003-2001; OE Type Thermostat .....	◆14078	180	1998; OE Exact Thermostat .....	◆48148	180
	◇14077	170	1998; Premium Thermostat .....	◆45758	180
<b>V-6 3.3 L</b>			1998; OE Type Thermostat .....	◆13758	180
2007-2004; OE Exact Thermostat .....	◆48128	180	<b>Pickup</b>		
2007-2004; OE Type Thermostat .....	◆14078	180	<b>4-Cyl. 2.4 L</b>		
	◇14077	170	1995; OE Exact Thermostat .....	◆48319	190
<b>V-6 3.3 L Electric Assist</b>			1995; Premium Thermostat .....	◆45869	195
2010-2006; OE Exact Thermostat .....	◆48128	180		◇45868	180
2010-2006; OE Type Thermostat .....	◆14078	180	1995; OE Type Thermostat .....	◆13869	195
	◇14077	170		◇13868	180
<b>V-6 3.5 L</b>			<b>V-6 3.0 L</b>		
2012-2011; OE Type Thermostat .....	◆14078	180	1995; OE Exact Thermostat .....	◆48288	180
2010-2008; OE Exact Thermostat .....	◆48128	180	1995; Premium Thermostat .....	◆45978	180
2010-2008; OE Type Thermostat .....	◆14078	180		◇45979	195
	◇14077	170	1995; OE Type Thermostat .....	◆13978	180
<b>V-6 3.5 L Electric Assist</b>				◇13979	195
2011; OE Type Thermostat .....	◆14078	180	<b>Previa</b>		
<b>Land Cruiser</b>			<b>4-Cyl. 2.4 L</b>		
<b>6-Cyl. 4.5 L</b>			1997-1995; OE Exact Thermostat .....	◆○48418	180
1997-1995; OE Type Thermostat .....	◆14128	180	1997-1995; OE Type Thermostat .....	◆14108	180
	◇14127	170	<b>Prius</b>		
<b>V-8 4.7 L</b>			<b>4-Cyl. 1.5 L Electric Assist</b>		
2007-1998; OE Type Thermostat .....	◆14128	180	2009-2001; OE Exact Thermostat .....	◆48308	180
	◇14127	170	2009-2001; OE Type Thermostat .....	◆14108	180
<b>Matrix</b>			<b>4-Cyl. 1.8 L Electric Assist</b>		
<b>4-Cyl. 1.8 L</b>			2010; OE Exact Thermostat Water Outlet Assembly .....	◆○48778	180
2011; OE Type Thermostat .....	◆14078	180	<b>RAV4</b>		
2010-2008; OE Exact Thermostat .....	◆48128	180	<b>4-Cyl. 2.0 L</b>		
2010-2008; OE Type Thermostat .....	◆14078	180	2003-2001; OE Exact Thermostat .....	◆48128	180
	◇14177	170	2003-2001; OE Type Thermostat .....	◆14078	180
2007-2003; OE Exact Thermostat .....	◆48128	180		◇14077	170
2007-2003; OE Type Thermostat .....	◆14078	180	2000-1997; OE Exact Thermostat .....	◆48278	180
	◇14077	170	2000-1997; Premium Thermostat .....	◆45758	180
			2000-1997; OE Type Thermostat .....	◆13758	180
			1996; OE Exact Thermostat .....	◆48148	180

◆ OE Temperature.  
○ Seal Included.

◇ Alternate Temperature.



## Thermostats for Passenger Cars and Light Trucks (1990 and Newer)

Application	Part Number	Temp°F	Application	Part Number	Temp°F
<b>Toyota - Continued</b>			<b>Toyota - Continued</b>		
<b>RAV4 - Continued</b>			<b>Solara - Continued</b>		
<b>4-Cyl. 2.0 L - Continued</b>			<b>V-6 3.3 L</b>		
1996; Premium Thermostat .....	◆45758	180	2008-2004; OE Exact Thermostat .....	◆48128	180
1996; OE Type Thermostat .....	◆13758	180	2008-2004; OE Type Thermostat .....	◆14078	180
<b>4-Cyl. 2.4 L</b>			◇14077 170		
2008-2004; OE Exact Thermostat .....	◆48128	180	<b>Supra</b>		
2008-2004; OE Type Thermostat .....	◆14078	180	<b>6-Cyl. 3.0 L</b>		
	◇14077	170	1998-1995; OE Exact Thermostat .....	◆48308	180
<b>4-Cyl. 2.5 L</b>			1998-1995; OE Type Thermostat .....	◆14108	180
2011; OE Type Thermostat .....	◆14078	180	<b>T100</b>		
2011; OE Exact Thermostat .....	◆48128	180	<b>4-Cyl. 2.7 L</b>		
2010-2009; OE Exact Thermostat .....	◆48128	180	1998-1995; OE Exact Thermostat .....	◆48418	180
2010-2009; OE Type Thermostat .....	◆14078	180	1998-1995; OE Type Thermostat .....	◆14108	180
	◇14077	170	<b>V-6 3.4 L</b>		
<b>V-6 3.5 L</b>			1998-1995; OE Exact Thermostat .....	◆48118	180
2011; OE Type Thermostat .....	◆14078	180	1998-1995; OE Type Thermostat .....	◆14078	180
2010; OE Exact Thermostat .....	◆48128	180		◇14077	170
2010; OE Type Thermostat .....	◆14078	180	<b>Tacoma</b>		
	◇14077	170	<b>4-Cyl. 2.4 L</b>		
2009; OE Exact Thermostat .....	◆48128	180	2004-1995; OE Exact Thermostat .....	◆48418	180
2009; OE Type Thermostat .....	◆14078	180	2004-1995; OE Type Thermostat .....	◆14108	180
	◇14177	170	<b>4-Cyl. 2.7 L</b>		
2008-2006; OE Type Thermostat .....	◆14078	180	2011; OE Exact Thermostat .....	◆48308	180
	◇14077	170	2010-2005; OE Exact Thermostat .....	◆48308	180
<b>Sequoia</b>			2010-2005; OE Type Thermostat .....	◆14108	180
<b>V-8 4.7 L</b>			2004-1995; OE Exact Thermostat .....	◆48418	180
2009-2002; OE Type Thermostat .....	◆14128	180	2004-1995; OE Type Thermostat .....	◆14108	180
	◇14127	170	<b>V-6 3.4 L</b>		
2001; OE Type Thermostat .....	◆14128	180	2004-1995; OE Exact Thermostat .....	◆48118	180
<b>Sienna</b>			2004-1995; OE Type Thermostat .....	◆14078	180
<b>4-Cyl. 2.7 L</b>				◇14077	170
2011; OE Type Thermostat .....	◆14078	180	<b>V-6 4.0 L</b>		
2011; OE Exact Thermostat .....	◆48128	180	2011-2005; OE Exact Thermostat Water Outlet		
<b>V-6 3.0 L</b>			Assembly .....	◆48778	180
2003-1998; OE Exact Thermostat .....	◆48128	180	<b>Tercel</b>		
2003-1998; OE Type Thermostat .....	◆14078	180	<b>4-Cyl. 1.5 L</b>		
	◇14077	170	1998-1995; OE Exact Thermostat .....	◆48148	180
<b>V-6 3.3 L</b>			1998-1995; Premium Thermostat .....	◆45758	180
2006-2004; OE Exact Thermostat .....	◆48128	180	1998-1995; OE Type Thermostat .....	◆13758	180
2006-2004; OE Type Thermostat .....	◆14078	180	<b>Tundra</b>		
	◇14077	170	<b>V-6 3.4 L</b>		
<b>V-6 3.5 L</b>			2004-2000; OE Exact Thermostat .....	◆48118	180
2011; OE Exact Thermostat .....	◆48128	180	2004-2000; OE Type Thermostat .....	◆14078	180
2011; OE Type Thermostat .....	◆14078	180		◇14077	170
2010; OE Type Thermostat .....	◆14078	180	<b>V-6 4.0 L</b>		
2009; OE Exact Thermostat .....	◆48128	180	2011-2005; OE Exact Thermostat Water Outlet		
2009; OE Type Thermostat .....	◆14078	180	Assembly .....	◆48778	180
	◇14177	170	<b>V-8 4.7 L</b>		
2008; OE Type Thermostat; Models made in USA. ....	◆14078	180	2009-2000; OE Type Thermostat .....	◆14128	180
	◇14077	170		◇14127	170
2007; OE Type Thermostat .....	◆14078	180	<b>Venza</b>		
	◇14077	170	<b>4-Cyl. 2.7 L</b>		
<b>Solara</b>			2011; OE Type Thermostat .....	◆14078	180
<b>4-Cyl. 2.2 L</b>			2011; OE Exact Thermostat .....	◆48128	180
2001; OE Exact Thermostat .....	◆48278	180	2009; OE Exact Thermostat .....	◆48128	180
2001; Premium Thermostat .....	◆45758	180	2009; OE Type Thermostat .....	◆14078	180
2001; OE Type Thermostat .....	◆13758	180		◇14077	170
<b>4-Cyl. 2.4 L</b>			<b>V-6 3.5 L</b>		
2008-2002; OE Exact Thermostat .....	◆48128	180	2011; OE Type Thermostat .....	◆14078	180
2008-2002; OE Type Thermostat .....	◆14078	180	2010-2009; OE Exact Thermostat .....	◆48128	180
	◇14077	170	2010-2009; OE Type Thermostat .....	◆14078	180
<b>V-6 3.0 L</b>				◇14077	170
2003; OE Exact Thermostat .....	◆48128	180	<b>Yaris</b>		
2003; OE Type Thermostat .....	◆14078	180	<b>4-Cyl. 1.5 L</b>		
	◇14077	170	2011; OE Exact Thermostat .....	◆48308	180
2002; OE Type Thermostat .....	◆14078	180	2010-2007; OE Exact Thermostat .....	◆48308	180
	◇14077	170			
2001; OE Exact Thermostat .....	◆48128	180			
2001; OE Type Thermostat .....	◆14078	180			
	◇14077	170			

◆ OE Temperature.  
○ Seal Included.

◇ Alternate Temperature.

## Thermostats for Passenger Cars and Light Trucks (1990 and Newer)

Application	Part Number	Temp°F	Application	Part Number	Temp°F
<b>Toyota - Continued</b>			<b>Volkswagen - Continued</b>		
<b>Yaris - Continued</b>			<b>Golf - Continued</b>		
4-Cyl. 1.5 L - Continued			4-Cyl. 1.9 L Diesel (Canada) - Continued		
2010-2007; OE Type Thermostat .....	◆14108	180	1998; OE Type Thermostat .....	◆13379	195
<b>Volkswagen</b>			◆13378	180	
<b>Beetle</b>			◇13376	160	
4-Cyl. 1.8 L			1997; Premium Thermostat .....	◆45378	180
2005-1999; OE Type Thermostat .....	◆14419	190	◇45379	195	
4-Cyl. 1.9 L Diesel			1997; OE Type Thermostat .....	◆13378	180
2006; OE Exact Thermostat .....	◆48499	190	◇13379	195	
2006; OE Type Thermostat .....	◆13379	195	◇13378	180	
2005-1998; OE Exact Thermostat .....	◆48499	190	◇13376	160	
2005-1998; Premium Thermostat .....	◆45379	195	4-Cyl. 2.0 L		
2005-1998; OE Type Thermostat .....	◇45378	180	2006-2000; OE Type Thermostat .....	◆14419	190
	◆13379	195	1999; Premium Thermostat: GTI .....	◆45399	195
	◇13378	180	◇45398	180	
	◇13376	160	1999; OE Type Thermostat: GTI .....	◆13399	195
4-Cyl. 2.0 L			◇13398	180	
2005-1998; OE Type Thermostat .....	◆14419	190	1999; Premium Thermostat; Exc. GTI .....	◆45379	195
<b>Cabrio</b>			◇45378	180	
4-Cyl. 2.0 L			1999; OE Type Thermostat; Exc. GTI .....	◆13379	195
2002-2000; Premium Thermostat .....	◆45379	195	◇13378	180	
◇45378	180		◇13376	160	
2002-2000; OE Type Thermostat .....	◆13379	195	1998-1995; Premium Thermostat .....		
◇13378	180		◇45379	195	
◇13376	160		◇45378	180	
1999; Premium Thermostat .....	◆45378	180	1998-1995; OE Type Thermostat .....	◆13379	195
◇45379	195		◇13378	180	
1999; OE Type Thermostat .....	◆13378	180	◇13376	160	
◇13379	195		4-Cyl. 2.0 L Diesel		
◇13376	160		2010; Premium Thermostat .....	◆45359	195
1998-1995; Premium Thermostat .....	◆45379	195	2010; OE Type Thermostat .....	◆14419	190
◇45378	180		V-6 2.8 L		
1998-1995; OE Type Thermostat .....	◆13379	195	2005-1995; OE Exact Thermostat .....	◆48668	176
◇13378	180		2005-1995; OE Type Thermostat .....	◆13648	180
◇13376	160		◇13649	190	
<b>Eurovan</b>			<b>Jetta</b>		
V-6 2.8 L			4-Cyl. 1.8 L		
2003; OE Type Thermostat .....	◆13648	180	2005-2000; OE Type Thermostat .....	◆14419	190
◇13649	190		4-Cyl. 1.9 L Diesel		
◇13496	160		2006-1998; OE Exact Thermostat .....	◆48499	190
2002-1999; OE Exact Thermostat .....	◆48668	176	2006-1998; Premium Thermostat .....	◆45379	195
2002-1999; OE Type Thermostat .....	◆13378	180	◇45378	180	
<b>Golf</b>			◇13379	195	
4-Cyl. 1.8 L			◇13378	180	
2004-2000; OE Type Thermostat .....	◆14419	190	◇13376	160	
4-Cyl. 1.8 L (Canada)			1997-1996; Premium Thermostat .....	◆45378	180
1997; Premium Thermostat .....	◆45379	195	◇45379	195	
◇45378	180		1997-1996; OE Type Thermostat .....	◆13378	180
1997; OE Type Thermostat .....	◆13379	195	◇13379	195	
◇13378	180		◇13376	160	
◇13376	160		4-Cyl. 2.0 L		
4-Cyl. 1.9 L Diesel			2011; OE Type Thermostat .....	◆14419	190
2006-1999; OE Exact Thermostat .....	◆48499	190	2005-2000; OE Type Thermostat .....	◆14419	190
2006-1999; Premium Thermostat .....	◆45379	195	1999; Premium Thermostat .....	◆45378	180
◇45378	180		◇45379	195	
2006-1999; OE Type Thermostat .....	◆13379	195	1999; OE Type Thermostat .....	◆13378	180
◇13378	180		◇13379	195	
◇13376	160		◇13376	160	
1996; Premium Thermostat .....	◆45378	180	1998-1995; Premium Thermostat .....	◆45379	195
◇45379	195		◇45378	180	
1996; OE Type Thermostat .....	◆13378	180	1998-1995; OE Type Thermostat .....	◆13379	195
◇13379	195		◇13378	180	
◇13376	160		◇13376	160	
4-Cyl. 1.9 L Diesel (Canada)			4-Cyl. 2.0 L Diesel		
1998; OE Exact Thermostat .....	◆48499	190	2010-2009; Premium Thermostat .....	◆45359	195
1998; Premium Thermostat .....	◆45379	195	2010-2009; OE Type Thermostat .....	◆14419	190
◇45378	180		5-Cyl. 2.5 L		
4-Cyl. 1.9 L Diesel (Canada)			2005; OE Type Thermostat .....	◆14419	190
1998; OE Exact Thermostat .....	◆48499	190	V-6 2.8 L		
1998; Premium Thermostat .....	◆45379	195	2004-1995; OE Exact Thermostat .....	◆48668	176
◇45378	180		2004-1995; OE Type Thermostat .....	◆13648	180
	◇45378	180	◇13649	190	

◆ OE Temperature.

◇ Alternate Temperature.

## Thermostats for Passenger Cars and Light Trucks (1990 and Newer)

Application	Part Number	Temp°F	Application	Part Number	Temp°F
<b>Volkswagen - Continued</b>			<b>Volvo - Continued</b>		
<b>Passat</b>			<b>C70 - Continued</b>		
4-Cyl. 1.8 L			5-Cyl. 2.4 L		
2005-1998; OE Type Thermostat .....	◆14419	190	2004; Premium Thermostat .....	◆45379	195
4-Cyl. 1.9 L Diesel			2004; OE Type Thermostat .....	◇45378	180
1998-1996; Premium Thermostat .....	◆45378	180		◆13379	195
	◇45379	195		◇13378	180
1998-1996; OE Type Thermostat .....	◆13378	180		◇13376	160
	◇13379	195	2003; Premium Thermostat .....	◇45399	195
	◇13376	160		◇45398	180
4-Cyl. 2.0 L			2003; OE Type Thermostat .....	◆13399	195
1996-1995; Premium Thermostat .....	◆45379	195		◇13398	180
	◇45378	180	2002; Premium Thermostat .....	◆45379	195
1996-1995; OE Type Thermostat .....	◆13379	195		◇45378	180
	◇13378	180	2002; OE Type Thermostat .....	◆13379	195
	◇13376	160		◇13378	180
4-Cyl. 2.0 L Diesel				◇13376	160
2005-2004; OE Exact Thermostat .....	◆48499	190	2001-1998; OE Exact Thermostat .....	◆48639	194
2005-2004; Premium Thermostat .....	◆45379	195	2001-1998; Premium Thermostat .....	◆45379	195
	◇45378	180		◇45378	180
2005-2004; OE Type Thermostat .....	◆13379	195	2001-1998; OE Type Thermostat .....	◆13379	195
	◇13378	180		◇13378	180
	◇13376	160		◇13376	160
V-6 2.8 L			5-Cyl. 2.5 L		
2005-2001; OE Type Thermostat .....	◆14099	190	2011; OE Type Thermostat .....	◆○14119	195
2000-1998; OE Exact Thermostat .....	◆○48049	189	2011; Premium Thermostat .....	◆○45119	195
2000-1998; OE Type Thermostat .....	◆14099	190	<b>S40</b>		
1997-1995; OE Exact Thermostat .....	◆48668	176	4-Cyl. 1.9 L		
1997-1995; OE Type Thermostat .....	◆13648	180	2004-2000; OE Exact Thermostat .....	◆48639	194
	◇13649	190		◆45379	195
				◇45378	180
			2004-2000; Premium Thermostat .....	◆13379	195
				◇13378	180
			2004-2000; OE Type Thermostat .....	◇13376	160
<b>Volvo</b>					
<b>850</b>			5-Cyl. 2.5 L		
5-Cyl. 2.3 L; 5-Cyl. 2.4 L			2011; OE Type Thermostat .....	◆○14119	195
1997-1995; OE Exact Thermostat .....	◆48639	194	2011; Premium Thermostat .....	◆○45119	195
1997-1995; Premium Thermostat .....	◆45379	195	<b>S60</b>		
	◇45378	180	5-Cyl. 2.3 L		
1997-1995; OE Type Thermostat .....	◆13379	195	2002; Premium Thermostat .....	◆45379	195
	◇13378	180		◇45378	180
	◇13376	160	2002; OE Type Thermostat .....	◆13379	195
				◇13378	180
				◇13376	160
			2001; OE Exact Thermostat .....	◆48639	194
			2001; Premium Thermostat .....	◆45379	195
				◇45378	180
			2001; OE Type Thermostat .....	◆13379	195
				◇13378	180
				◇13376	160
<b>940</b>			5-Cyl. 2.4 L		
4-Cyl. 2.3 L			2002-2001; OE Exact Thermostat .....	◆48639	194
1995; OE Exact Thermostat .....	◆○48078	180	2002-2001; Premium Thermostat .....	◆45379	195
1995; OE Type Thermostat .....	◆13919	195		◇45378	180
	◇13918	180	2002-2001; OE Type Thermostat .....	◆13379	195
				◇13378	180
				◇13376	160
<b>960</b>			<b>S70</b>		
6-Cyl. 2.9 L			5-Cyl. 2.3 L; 5-Cyl. 2.4 L		
1997-1995; OE Exact Thermostat .....	◆48639	194	2000-1998; OE Exact Thermostat .....	◆48639	194
1997-1995; Premium Thermostat .....	◆45379	195	2000-1998; Premium Thermostat .....	◆45379	195
	◇45378	180		◇45378	180
1997-1995; OE Type Thermostat .....	◆13379	195	2000-1998; OE Type Thermostat .....	◆13379	195
	◇13378	180		◇13378	180
	◇13376	160		◇13376	160
<b>C30</b>			<b>S80</b>		
5-Cyl. 2.5 L			5-Cyl. 2.5 L		
2011; OE Type Thermostat .....	◆○14119	195	2005; OE Exact Thermostat .....	◆48499	190
2011; Premium Thermostat .....	◆○45119	195	2005; Premium Thermostat .....	◆45379	195
				◇45378	180
<b>C70</b>					
5-Cyl. 2.3 L					
2004-2002; Premium Thermostat .....	◆45379	195			
	◇45378	180			
2004-2002; OE Type Thermostat .....	◆13379	195			
	◇13378	180			
	◇13376	160			
2001-1998; OE Exact Thermostat .....	◆48639	194			
2001-1998; Premium Thermostat .....	◆45379	195			
	◇45378	180			
2001-1998; OE Type Thermostat .....	◆13379	195			
	◇13378	180			
	◇13376	160			

◆ OE Temperature.  
○ Seal Included.

◇ Alternate Temperature.

## Thermostats for Passenger Cars and Light Trucks (1990 and Newer)

Application	Part Number	Temp°F	Application	Part Number	Temp°F
<b>Volvo - Continued</b>			<b>Volvo - Continued</b>		
<b>S80 - Continued</b>			<b>V90 - Continued</b>		
<b>5-Cyl. 2.5 L - Continued</b>			<b>6-Cyl. 2.9 L - Continued</b>		
2005; OE Type Thermostat .....	◆13379	195	1998-1997; Premium Thermostat .....	◆45379	195
	◇13378	180		◇45378	180
	◇13376	160	1998-1997; OE Type Thermostat .....	◆13379	195
<b>6-Cyl. 2.8 L</b>				◇13378	180
2001; OE Exact Thermostat .....	◆○48839	194		◇13376	160
2000-1999; Premium Thermostat .....	◆45379	195	<b>XC90</b>		
	◇45378	180	<b>6-Cyl. 2.9 L</b>		
2000-1999; OE Type Thermostat .....	◆13379	195	2005-2003; OE Exact Thermostat .....	◆○48839	194
	◇13378	180	<b>V-8 4.4 L</b>		
	◇13376	160	2011; OE Type Thermostat .....	◆14128	180
<b>6-Cyl. 2.9 L</b>			2009-2005; OE Type Thermostat .....	◆14128	180
2005-2000; OE Exact Thermostat .....	◆○48839	194			
1999; Premium Thermostat .....	◆45379	195			
	◇45378	180			
1999; OE Type Thermostat .....	◆13379	195			
	◇13378	180			
	◇13376	160			
<b>V-8 4.4 L</b>					
2010-2007; OE Type Thermostat .....	◆14128	180			
<b>S90</b>					
<b>6-Cyl. 2.9 L</b>					
1998-1997; OE Exact Thermostat .....	◆48639	194			
1998-1997; Premium Thermostat .....	◆45379	195			
	◇45378	180			
1998-1997; OE Type Thermostat .....	◆13379	195			
	◇13378	180			
	◇13376	160			
<b>V40</b>					
<b>4-Cyl. 1.9 L</b>					
2004-2000; OE Exact Thermostat .....	◆48639	194			
2004-2000; Premium Thermostat .....	◆45379	195			
	◇45378	180			
2004-2000; OE Type Thermostat .....	◆13379	195			
	◇13378	180			
	◇13376	160			
<b>V50</b>					
<b>5-Cyl. 2.5 L</b>					
2011; OE Type Thermostat .....	◆○14119	195			
2011; Premium Thermostat .....	◆○45119	195			
<b>V70</b>					
<b>5-Cyl. 2.3 L</b>					
2002; Premium Thermostat .....	◆45379	195			
	◇45378	180			
2002; OE Type Thermostat .....	◆13379	195			
	◇13378	180			
	◇13376	160			
2001-1998; OE Exact Thermostat .....	◆48639	194			
2001-1998; Premium Thermostat .....	◆45379	195			
	◇45378	180			
2001-1998; OE Type Thermostat .....	◆13379	195			
	◇13378	180			
	◇13376	160			
<b>5-Cyl. 2.4 L</b>					
2003; Premium Thermostat .....	◆45379	195			
	◇45378	180			
2003; OE Type Thermostat .....	◆13379	195			
	◇13378	180			
	◇13376	160			
2002-1998; OE Exact Thermostat .....	◆48639	194			
2002-1998; Premium Thermostat .....	◆45379	195			
	◇45378	180			
2002-1998; OE Type Thermostat .....	◆13379	195			
	◇13378	180			
	◇13376	160			
<b>V90</b>					
<b>6-Cyl. 2.9 L</b>					
1998-1997; OE Exact Thermostat .....	◆48639	194			

◆ OE Temperature.  
○ Seal Included.

◇ Alternate Temperature.

## Cap Numerical Listing

Use as a Guide Only. Alphabetical Listing provides more detail.

Make	Year(s)	Make	Year(s)	Make	Year(s)	Make	Year(s)
<b>10066</b>		<b>10099 - Continued</b>		<b>10120</b>		<b>10143 - Continued</b>	
Chevrolet .....	1999-1995	Chevrolet .....	2011-1995	Chrysler .....	2010-2007	Hyundai .....	2009-1999
Chrysler .....	1998-1995	Chrysler .....	2010-1998	Dodge .....	2011-2000	Kia .....	2010-2001
Dodge .....	2002-1995	Dodge .....	2010-1998	Jeep .....	2010-1999	<b>10144</b>	
Eagle .....	1997-1995	GMC .....	2011-1995	Mitsubishi .....	2009-2006	Ford .....	2009-2004
GMC .....	1999-1995	Hummer .....	2010-2002	<b>10121</b>		Mazda .....	2011-2004
Jeep .....	2002-1995	Isuzu .....	2008-1997	Lexus .....	2008-1997	Mercury .....	2008-2006
Plymouth .....	1998-1995	Oldsmobile .....	2004-1995	Toyota .....	2010-1997	<b>10145</b>	
<b>10071</b>		Pontiac .....	2009-1995	<b>10122</b>		Chrysler .....	2008-2007
Ford .....	1997-1995	Saab .....	2009-2003	Buick .....	1996-1995	Dodge .....	2008-2003
<b>10072</b>		Saturn .....	2009-1995	Chevrolet .....	1997-1995	<b>10146</b>	
Chevrolet .....	1996-1995	<b>10100</b>		Oldsmobile .....	1996-1995	Saab .....	2008-1999
GMC .....	1996-1995	Ford .....	1996-1995	Pontiac .....	1998-1995	<b>10147</b>	
Pontiac .....	1995	Mercury .....	1996-1995	<b>10123</b>		Land Rover .....	2004-1996
<b>10075</b>		<b>10101</b>		Chevrolet .....	2001-1998	<b>10148</b>	
Dodge .....	1998-1995	Acura .....	1998-1996	Pontiac .....	2001-2000	Chrysler .....	2009-2007
Jeep .....	1997-1995	Ford .....	2005-1995	<b>10125</b>		Dodge .....	2009-2007
<b>10079</b>		Geo .....	1997-1995	Chevrolet .....	2003-1998	<b>10225</b>	
Audi .....	2010-1995	Honda .....	2002-1995	GMC .....	2003-1998	Audi .....	2003-1995
BMW .....	2005-1995	Isuzu .....	2004-1995	Isuzu .....	2000-1998	Porsche .....	1998-1997
Mercedes-Benz .....	2005-1995	Jaguar .....	2008-2005	<b>10128</b>		<b>10227</b>	
Porsche .....	2006	Lincoln .....	2006-2002	Chevrolet .....	1997-1995	Chrysler .....	1998-1995
Volkswagen .....	2010-1995	Mazda .....	2008-2001	GMC .....	1997-1995	Dodge .....	1999-1995
<b>10080</b>		Mercury .....	2002-1995	Isuzu .....	1997-1996	Eagle .....	1998-1995
Chevrolet .....	2002-1998	Pontiac .....	1997-1995	<b>10129</b>		Ford .....	1997-1995
Geo .....	1997-1995	<b>10105</b>		Volvo .....	2008-1995	Hyundai .....	2010-1995
Lexus .....	2011-1995	Buick .....	1998-1995	<b>10130</b>		Infiniti .....	2010-1995
Pontiac .....	2010-2003	Cadillac .....	2000-1995	Audi .....	2005	Kia .....	2011-1995
Scion .....	2004	Chevrolet .....	2002-1995	Dodge .....	2009-2008	Lexus .....	2000-1995
Toyota .....	2011-1995	GMC .....	2000-1995	Freightliner .....	2009-2008	Mazda .....	2010-1995
<b>10081</b>		Jaguar .....	2010	Jeep .....	2007	Mercury .....	2002-1995
Acura .....	2005-1995	Oldsmobile .....	2001-1996	Mercedes-Benz .....	2011-1995	Mitsubishi .....	2002-1995
Chevrolet .....	2004-1998	Pontiac .....	2002-1995	Volkswagen .....	2005	Nissan .....	2011-1995
Ford .....	2011-1995	<b>10107</b>		<b>10131</b>		Subaru .....	1999-1995
Geo .....	1997	Infiniti .....	2011-1995	BMW .....	2010-1997	Suzuki .....	1995
Honda .....	2009-1995	Mercury .....	2002-1995	Land Rover .....	2005-2003	Toyota .....	2004-1995
Hyundai .....	2011-2000	Nissan .....	2011-1995	<b>10132</b>		<b>10229</b>	
Isuzu .....	2000-1996	<b>10110</b>		Buick .....	1995	Ford .....	1998-1995
Jeep .....	2006-2005	Subaru .....	2010-1995	Chevrolet .....	1995	Jeep .....	1995
Kia .....	2011-2001	<b>10111</b>		Oldsmobile .....	1995	Porsche .....	1995
Land Rover .....	2005-2002	Chrysler .....	2010-1995	Pontiac .....	1995	<b>10230</b>	
Lincoln .....	2005-1995	Dodge .....	2011-1995	<b>10133</b>		AM General .....	2001-1996
Mazda .....	2003-1995	Eagle .....	1998-1995	Lexus .....	2011-2006	Cadillac .....	2000-1995
Mercury .....	2007-1995	Jeep .....	2010-1995	Pontiac .....	2006	Chevrolet .....	2005-1995
Pontiac .....	2000-1997	Mini .....	2008-2002	Scion .....	2011-2005	Chrysler .....	2011-1995
Saturn .....	2007-2004	Mitsubishi .....	2009-1995	Toyota .....	2011-2000	Dodge .....	2011-1995
Suzuki .....	2004-1995	Plymouth .....	2001-1995	<b>10134</b>		Eagle .....	1997-1995
<b>10082</b>		Volkswagen .....	2010-2009	Acura .....	2011-2000	Ford .....	1997-1995
Ford .....	1997-1995	<b>10112</b>		Ford .....	1998	GMC .....	2005-1995
Hyundai .....	2011-1995	Toyota .....	1997-1995	Honda .....	2011-1995	Hummer .....	2006-2002
Kia .....	2011-1995	<b>10113</b>		Isuzu .....	1995	Isuzu .....	2000-1996
Mazda .....	2011-1995	Lexus .....	1999-1995	Suzuki .....	2008-2004	Jaguar .....	1996-1995
Mercury .....	1996-1995	Toyota .....	1998-1995	<b>10135</b>		Jeep .....	2011-2003
<b>10083</b>		<b>10114</b>		Lexus .....	2011-2006	Mazda .....	1997-1995
Geo .....	1995	Chevrolet .....	2005-1996	Pontiac .....	2006	Mercury .....	1995
Mitsubishi .....	1996-1995	GMC .....	2005-1996	Scion .....	2011-2005	Mini .....	2008-2002
Pontiac .....	1995	<b>10117</b>		Toyota .....	2011-2000	Mitsubishi .....	2008-2006
Suzuki .....	1995	Dodge .....	2010	<b>10136</b>		Oldsmobile .....	2001-1996
<b>10088</b>		Ford .....	2011-2000	Dodge .....	1999-1995	Plymouth .....	2001-1995
Chrysler .....	2005-1995	Jaguar .....	2008-2000	<b>10137</b>		Porsche .....	1995
Dodge .....	2005-1995	Land Rover .....	2009-2005	Kia .....	2005-2001	<b>10231</b>	
Eagle .....	1998-1995	Lincoln .....	2011-2001	<b>10138</b>		Buick .....	2007-1995
Hyundai .....	2006-1995	Mazda .....	2011-2001	Hyundai .....	2001-1996	Cadillac .....	2000-1995
Kia .....	2006-2002	Mercury .....	2011-2001	Kia .....	2002-2001	Chevrolet .....	2006-1995
Mitsubishi .....	2009-1995	<b>10118</b>		<b>10140</b>		Chrysler .....	2010-1995
Plymouth .....	2000-1995	Cadillac .....	1995	Cadillac .....	2004-1997	Dodge .....	2010-1995
Pontiac .....	2005	<b>10119</b>		Chevrolet .....	2007-2004	Ford .....	1995
<b>10099</b>		Chevrolet .....	1997-1995	Daewoo .....	2002-1999	GMC .....	2005-1995
AM General .....	2001-1996	Oldsmobile .....	1996-1995	Saturn .....	2005-2000	Jeep .....	2001-1995
BMW .....	2011-2007	Pontiac .....	1996-1995	Suzuki .....	2008-2004	Oldsmobile .....	2004-1995
Buick .....	2011-1995	<b>10143</b>		<b>10143</b>		Plymouth .....	2000-1995
Cadillac .....	2011-1995					Pontiac .....	2006-1995

# Cap Numerical Listing

Use as a Guide Only. Alphabetical Listing provides more detail.

Make	Year(s)	Make	Year(s)	Make	Year(s)	Make	Year(s)		
<b>10231 - Continued</b>		<b>10242 - Continued</b>		<b>10260</b>		<b>10331 - Continued</b>			
Saturn .....	2006-2005	Chevrolet .....	2004-1998	Saab .....	1998-1995	Ford .....	1995		
<b>10233</b>		Chrysler .....	2005-2001	<b>10261</b>		GMC .....	2005-1995		
Acura .....	2005-1995	Dodge .....	2005-2001	Cadillac .....	2001-1997	Jeep .....	2001-1995		
BMW .....	2008	Geo .....	1997-1995	Daewoo .....	2002-1999	Oldsmobile .....	2004-1995		
Chrysler .....	1999-1995	Honda .....	2011-1995	Ford .....	2011-2009	Plymouth .....	2000-1995		
Dodge .....	1999-1995	Hyundai .....	2008	Saab .....	2008-2006	Pontiac .....	2006-1995		
Eagle .....	1998-1995	Isuzu .....	2003-1996	<b>10262</b>		Saturn .....	2006-2005		
Ford .....	2011-1995	Lexus .....	2011-1998	Mazda .....	2010-2004	<b>10333</b>			
Honda .....	2007-1995	Mazda .....	2011-2000	Volvo .....	2011-2004	Acura .....	2005-1995		
Hyundai .....	2011-1998	Mitsubishi .....	2011-2001	<b>10263</b>		Chrysler .....	1999-1995		
Infiniti .....	2010-1997	Pontiac .....	2000-1995	Jaguar .....	2007-1997	Dodge .....	1999-1995		
Isuzu .....	2004-1995	Scion .....	2011-2004	<b>10264</b>		Eagle .....	1998-1995		
Kia .....	2011-2001	Subaru .....	2011-2001	Infiniti .....	2009-2004	Ford .....	2011-1995		
Lexus .....	2007-1995	Suzuki .....	2010-1995	Nissan .....	2012-2004	Honda .....	2007-1995		
Lincoln .....	2011-2009	Toyota .....	2012-1995	<b>10265</b>		Hyundai .....	2011-1998		
Mazda .....	2010-1995	Volkswagen .....	2004	Ford .....	2011-2008	Infiniti .....	2010-1997		
Mercury .....	2001-1995	<b>10243</b>		<b>10266</b>		Isuzu .....	2004-1995		
Mitsubishi .....	2011-1995	Volkswagen .....	2003-1995	<b>10267</b>		Kia .....	2011-2001		
Nissan .....	2012-1995	<b>10244</b>		Ford .....	2010-2006	Lexus .....	2007-1995		
Subaru .....	2011-1999	Volvo .....	2011-1995	Infiniti .....	2010-2007	Lincoln .....	2011-2009		
Suzuki .....	2008-2004	<b>10246</b>		Mazda .....	2010-2003	Mazda .....	2010-1995		
Toyota .....	2008-1995	Land Rover .....	2005-1995	Mercury .....	2010-2006	Mercury .....	2001-1995		
<b>10234</b>		<b>10247</b>		Nissan .....	2012-2007	Mitsubishi .....	2011-1995		
Cadillac .....	2005-2001	BMW .....	2010-1995	<b>10268</b>		Nissan .....	2012-1995		
Chevrolet .....	2002-1995	<b>10248</b>		Ford .....	2011	Subaru .....	2011-1999		
Chrysler .....	2010-2002	Buick .....	2011-2004	<b>10327</b>		Suzuki .....	2008-2004		
Dodge .....	2011-1999	Cadillac .....	2011-2002	Chrysler .....	1998-1995	Toyota .....	2004-1995		
Freightliner .....	2005-2003	Chevrolet .....	2011-1999	Dodge .....	1999-1995	<b>10329</b>			
Jeep .....	2010-1995	GMC .....	2012-1999	Eagle .....	1998-1995	Ford .....	1998-1995		
Oldsmobile .....	2003-2001	Hummer .....	2010-2003	Ford .....	1997-1995	Jeep .....	1995		
Pontiac .....	2006-1995	Isuzu .....	2008-2003	Hyundai .....	2010-1995	Porsche .....	1995		
<b>10235</b>		Mazda .....	2010-2003	Infiniti .....	2010-1995	<b>10330</b>			
Chrysler .....	2009-2007	Oldsmobile .....	2004-1999	Kia .....	2011-1995	AM General .....	2001-1996		
Dodge .....	2009-2001	Pontiac .....	2010-1999	Lexus .....	2000-1995	Cadillac .....	2000-1995		
Jeep .....	2002-1999	Saab .....	2009-2005	Mazda .....	2010-1995	Chevrolet .....	2005-1995		
Mercedes-Benz .....	2010-1995	Saturn .....	2009-2003	Mercury .....	2002-1995	Chrysler .....	2011-1995		
<b>10236</b>		Suzuki .....	2009-2007	Mitsubishi .....	2002-1995	Dodge .....	2002-1995		
Buick .....	2005-1995	<b>10249</b>		Nissan .....	2011-1995	Eagle .....	1998-1995		
Chevrolet .....	2005-1995	Audi .....	2011-1996	Subaru .....	1999-1995	Ford .....	2008-1995		
Ford .....	2001	Porsche .....	2010-2003	Suzuki .....	1995	GMC .....	2011-1995		
Pontiac .....	2005-1998	Volkswagen .....	2012-1998	Toyota .....	2004-1995	Infiniti .....	2000-1995		
Saturn .....	2005	<b>10250</b>		<b>10329</b>		Jeep .....	2001-1995		
<b>10238</b>		Ford .....	2005-1995	Ford .....	1998-1995	Kia .....	2002-1995		
Ford .....	2011-1995	Mercury .....	1997-1995	Jeep .....	1995	Land Rover .....	2004-1995		
Infiniti .....	2009-2004	<b>10251</b>		Porsche .....	1995	Lincoln .....	1997-1995		
Jaguar .....	2010-2000	Ford .....	2011-1998	<b>10330</b>		Mazda .....	1999-1995		
Land Rover .....	2009-2003	Mazda .....	2011-2001	AM General .....	2001-1996	Mercury .....	1999-1995		
Lincoln .....	2011-1995	Mercury .....	2010-1998	Cadillac .....	2000-1995	Mitsubishi .....	1997-1995		
Mazda .....	2009-2001	<b>10252</b>		Chrysler .....	2011-1995	Nissan .....	2001-1995		
Mercury .....	2011-1995	Dodge .....	2010-2006	Dodge .....	2011-1995	Oldsmobile .....	1997-1995		
Nissan .....	2009-2004	Freightliner .....	2011-2006	Eagle .....	1997-1995	Plymouth .....	2001-1995		
<b>10239</b>		<b>10253</b>		Ford .....	1997-1995	Pontiac .....	1997-1995		
Buick .....	1998-1995	Mercedes-Benz .....	2010-1996	Ford .....	1997-1995	Saturn .....	1997-1995		
Cadillac .....	2000-1995	<b>10254</b>		GMC .....	2005-1995	Subaru .....	2000-1995		
Chevrolet .....	2000-1995	Lexus .....	2011-2007	Hummer .....	2006-2002	Suzuki .....	1995		
Oldsmobile .....	1999-1995	Scion .....	2012-2008	Isuzu .....	2000-1996	Volvo .....	1998-1995		
Pontiac .....	2004-1995	Toyota .....	2011-2000	Jaguar .....	1996-1995	<b>10501D</b>			
Saturn .....	2002-1995	<b>10255</b>		Jeep .....	2011-2003	Chevrolet .....	2011-1995		
<b>10241</b>		Cadillac .....	2004-2001	Mazda .....	1997-1995	Dodge .....	2002-1995		
Chevrolet .....	2002-1998	Chevrolet .....	2004-2001	Mercury .....	1995	Eagle .....	1998-1995		
Dodge .....	2001	<b>10257</b>		Mini .....	2008-2002	Ford .....	2008-1995		
Eagle .....	1996-1995	Cadillac .....	2004-2001	Mitsubishi .....	2008-2006	GMC .....	2011-1995		
Geo .....	1997-1995	<b>10258</b>		Oldsmobile .....	2001-1996	Infiniti .....	2000-1995		
Lexus .....	2008-1995	Mercedes-Benz .....	2005-1998	Plymouth .....	2001-1995	Jeep .....	2001-1995		
Mazda .....	1999-1995	<b>10259</b>		Porsche .....	1995	Kia .....	2002-1995		
Mitsubishi .....	2004-1995	Chevrolet .....	2011-2004	<b>10331</b>		Land Rover .....	2004-1995		
Pontiac .....	2010-1995	Pontiac .....	2009-2005	Buick .....	2007-1995	Lincoln .....	1997-1995		
Scion .....	2010-2005	Saab .....	2005-1995	Cadillac .....	2000-1995	Mazda .....	2004-1998		
Subaru .....	2010-2006	Saturn .....	2005-2000	Chevrolet .....	2006-1995	<b>10502</b>			
Suzuki .....	2002-2001	Suzuki .....	2006-2004	Chrysler .....	2010-1995	Ford .....	2005-1996		
Toyota .....	2011-1995	<b>10242</b>		Dodge .....	2010-1995	Lincoln .....	2006-1996		
<b>10242</b>		Acura .....	2011-1995					Mazda .....	2004-1998

## Cap Numerical Listing

Use as a Guide Only. Alphabetical Listing provides more detail.

Make	Year(s)	Make	Year(s)	Make	Year(s)	Make	Year(s)
<b>10502 - Continued</b>		<b>10508 - Continued</b>		<b>10523</b>		<b>10817 - Continued</b>	
Mercury .....	2005-1996	Plymouth .....	2001-1999	Buick .....	2011-2006	Chrysler .....	2002-1995
<b>10502D</b>		Subaru .....	2011-2005	Cadillac .....	2011-2005	Dodge .....	2002-1995
Ford .....	2005-1997	Volkswagen .....	2011-2009	Chevrolet .....	2011-2005	Eagle .....	1998-1995
<b>10502Y</b>		<b>10508D</b>		GMC .....	2009-2005	Ford .....	2008-1995
Ford .....	2005-1996	Dodge .....	2012-2000	Pontiac .....	2009-2006	GMC .....	2011-1995
Mazda .....	2002-2000	Jeep .....	2009-2005	<b>10582</b>			
Mercury .....	2004-2002	Mercedes-Benz .....	2009-2007	Audi .....	2010-2008	Infiniti .....	2000-1995
<b>10503</b>		<b>10508Y</b>		BMW .....	1998-1997	Jeep .....	2001-1995
Ford .....	2001-1996	Chrysler .....	2012-1999	<b>10591</b>			
Mercury .....	1997	Dodge .....	2012-1999	Buick .....	1997-1995	Kia .....	2002-1995
<b>10504</b>		Jeep .....	2012-2007	Cadillac .....	1996-1995	Land Rover .....	2004-1999
Acura .....	2005-1995	Nissan .....	2011-2007	Chevrolet .....	2011-1995	Mazda .....	1999-1995
Audi .....	2005-2002	Plymouth .....	2000-1999	Chrysler .....	2002-1995	Mitsubishi .....	1997-1995
Buick .....	2011-1996	Volkswagen .....	2011	Plymac .....	1997-1995	Nissan .....	2001-1995
Cadillac .....	2011-1999	<b>10509</b>		Dodge .....	2002-1995	Oldsmobile .....	1997-1995
Chevrolet .....	2011-1995	Lexus .....	2009-2002	Eagle .....	1998-1995	Plymouth .....	2001-1995
Daewoo .....	2002-1999	Pontiac .....	2005	Ford .....	2008-1995	Pontiac .....	1997-1995
Dodge .....	2000	Scion .....	2010-2005	GMC .....	2011-1995	Subaru .....	2000-1995
GMC .....	2011-1997	Toyota .....	2009-2002	Infiniti .....	2000-1995	Suzuki .....	1995
Honda .....	2006-1995	<b>10510</b>		Jeep .....	2001-1995	Volvo .....	1998-1995
Hummer .....	2004-2003	Ford .....	2012-2004	Kia .....	2002-1995	<b>10819</b>	
Infiniti .....	2002-2001	Lincoln .....	2011-2004	Land Rover .....	2004-1999	Buick .....	1997-1995
Isuzu .....	2004-1995	Mazda .....	2011-2004	Mazda .....	1999-1995	Cadillac .....	1997-1995
Lexus .....	2012-2000	Mercury .....	2011-2004	Mitsubishi .....	1997-1995	Chevrolet .....	2011-1995
Mazda .....	2011-1997	<b>10510D</b>		Nissan .....	2001-1995	Chrysler .....	2002-1995
Mercedes-Benz .....	2009-1998	Ford .....	2012-2004	Oldsmobile .....	1997-1995	Dodge .....	2002-1995
Mitsubishi .....	2010-1997	<b>10510Y</b>		Plymouth .....	2001-1995	Eagle .....	1998-1995
Nissan .....	2011-2001	Ford .....	2012-2004	Pontiac .....	1997-1995	Ford .....	2008-1995
Oldsmobile .....	1997-1996	Lincoln .....	2011-2007	Subaru .....	2000-1995	GMC .....	2011-1995
Pontiac .....	2010-1995	Mercury .....	2011-2004	Suzuki .....	1995	Infiniti .....	2000-1995
Saab .....	2006-1996	<b>10511</b>		Volvo .....	1998-1995	Jeep .....	2001-1995
Scion .....	2012-2004	Buick .....	2011-2004	<b>10591D</b>			
Subaru .....	2011-2001	Cadillac .....	2011-2004	Chevrolet .....	2011-1995	Kia .....	2002-1995
Suzuki .....	2011-2004	Chevrolet .....	2011-2004	Dodge .....	1999-1995	Land Rover .....	2004-1999
Toyota .....	2012-1999	GMC .....	2011-2004	Ford .....	2008-1995	Mazda .....	1999-1995
Volkswagen .....	2010-2009	Hummer .....	2009-2004	GMC .....	2011-1995	Mercury .....	1999-1995
Volvo .....	2010-1998	Isuzu .....	2008-2005	<b>10594</b>			
<b>10504Y</b>		Pontiac .....	2009-2004	Chevrolet .....	1997-1995	Mitsubishi .....	1997-1995
Buick .....	2011	Saab .....	2009-2005	Pontiac .....	1997-1995	Nissan .....	2001-1995
Chevrolet .....	2011-2002	Saturn .....	2010-2003	<b>10595</b>			
GMC .....	2011-2002	Suzuki .....	2009-2004	Bentley .....	2005-1999	Oldsmobile .....	1997-1995
Toyota .....	2012-2009	<b>10511Y</b>		Chevrolet .....	2004-1998	Plymouth .....	2001-1995
<b>10505</b>		Cadillac .....	2011-2010	Eagle .....	1996-1995	Pontiac .....	1997-1995
Audi .....	2011-1995	Chevrolet .....	2011-2004	Geo .....	1997-1995	Saturn .....	1997-1995
Volkswagen .....	2010-1995	GMC .....	2011-2004	Hyundai .....	2006-1995	Subaru .....	2000-1995
<b>10506</b>		<b>10512</b>		Kia .....	2006-2001	Suzuki .....	1995
Buick .....	2005-1997	Hyundai .....	2011-2004	Lexus .....	2012-1995	Volvo .....	1998-1995
Cadillac .....	2005-1998	Infiniti .....	2011-2010	Mitsubishi .....	1997-1995	<b>10819D</b>	
Chevrolet .....	2005-1996	Kia .....	2011-2004	Pontiac .....	2000-1995	Chevrolet .....	2011-1995
GMC .....	2005-1996	<b>10516</b>		Subaru .....	1995	Dodge .....	1999-1995
Isuzu .....	2004-1997	Chevrolet .....	1998	Suzuki .....	2004-1995	Ford .....	2008-1995
Oldsmobile .....	2004-1996	Pontiac .....	1998	Toyota .....	2010-1995	GMC .....	2011-1995
Pontiac .....	2005-1997	<b>10517</b>		Volkswagen .....	2010	<b>10821</b>	
Saturn .....	2006-1998	Cadillac .....	2001-1999	<b>10596</b>			
<b>10507</b>		<b>10518</b>		AM General .....	2001-1996	Ford .....	1995
Acura .....	2011-2004	Cadillac .....	2006-2005	Audi .....	2007	<b>10822</b>	
Ford .....	2004-1998	Chevrolet .....	2006-2004	Cadillac .....	1998-1997	Chevrolet .....	1997-1995
Honda .....	2011-2005	GMC .....	2005-2004	Hummer .....	2006-2002	Pontiac .....	1997-1995
Jaguar .....	2008-2002	Saab .....	2007-2004	Mazda .....	1995	<b>10823</b>	
Mercury .....	2000-1998	<b>10521</b>		Porsche .....	2010-1995	Chevrolet .....	1997-1995
Volkswagen .....	2005-2004	Ford .....	2012-2010	Saab .....	2000-1995	Pontiac .....	1997-1995
<b>10508</b>		Land Rover .....	2008-2005	Volkswagen .....	2010-2004	<b>10825</b>	
Chrysler .....	2012-1999	Mazda .....	2010-2004	<b>10597</b>			
Dodge .....	2012-1999	Volvo .....	2011-2004	Audi .....	2010-2004	Bentley .....	2005-1999
Ford .....	2011-2010	<b>10522</b>		Volkswagen .....	2011-2002	Chevrolet .....	2004-1998
Infiniti .....	2012-2002	Chevrolet .....	2003-1998	<b>10810</b>			
Jeep .....	2012-2000	GMC .....	2004-1998	Audi .....	2010-2008	Eagle .....	1996-1995
Mazda .....	2011-2003	<b>10508</b>		BMW .....	1998-1995	Geo .....	1997-1995
Mercedes-Benz .....	2011-2006	Chrysler .....	2012-1999	Mercedes-Benz .....	1995	Hyundai .....	2006-1995
Mercury .....	2002-2000	Dodge .....	2012-1999	<b>10817</b>			
Mitsubishi .....	2010-2001	Ford .....	2012-2002	Buick .....	1997-1995	Kia .....	2006-2001
Nissan .....	2012-2000	Jaguar .....	2008-2002	Cadillac .....	1996-1995	Lexus .....	2012-1995
<b>10509</b>		Land Rover .....	2008-2005	Chevrolet .....	1999-1995	Mitsubishi .....	1997-1995
Lexus .....	2009-2002	Mazda .....	2010-2004	<b>10826</b>			
Pontiac .....	2005	Volvo .....	2011-2004	AM General .....	2001-1996	Audi .....	2007
Scion .....	2010-2005	<b>10509</b>		Cadillac .....	1998-1997	Cadillac .....	1998-1997
Toyota .....	2009-2002	Ford .....	2012-2004	Hummer .....	2006-2002	Hummer .....	2006-2002
<b>10510</b>		Lincoln .....	2011-2007	Mazda .....	1995	<b>10817</b>	
Ford .....	2012-2004	Mercury .....	2011-2004	Porsche .....	2010-1995	Audi .....	2001-1996
Lincoln .....	2011-2004	<b>10511</b>		Saab .....	2000-1995	BMW .....	1998-1995
Mazda .....	2011-2004	Buick .....	2011-2004	Volkswagen .....	2010-2004	Mercedes-Benz .....	1995
Mercury .....	2011-2004	Cadillac .....	2011-2004	<b>10819</b>			
<b>10510D</b>		Chevrolet .....	2011-2004	Buick .....	1997-1995	Cadillac .....	1997-1995
Ford .....	2012-2004	GMC .....	2011-2004	Chevrolet .....	2011-1995	Chevrolet .....	2011-1995
<b>10510Y</b>		Hummer .....	2009-2004	Dodge .....	1999-1995	Dodge .....	2002-1995
Ford .....	2012-2004	Isuzu .....	2008-2005	Ford .....	2008-1995	Eagle .....	1998-1995
Lincoln .....	2011-2007	Pontiac .....	2009-2004	GMC .....	2011-1995	Ford .....	2008-1995
Mercury .....	2011-2004	Saab .....	2009-2005	Infiniti .....	2000-1995	GMC .....	2011-1995
<b>10511</b>		Saturn .....	2010-2003	Jeep .....	2001-1995	Infiniti .....	2000-1995
Buick .....	2011-2004	Suzuki .....	2009-2004	Kia .....	2002-1995	Jeep .....	2001-1995
Cadillac .....	2011-2004	<b>10511Y</b>		Land Rover .....	2004-1999	Kia .....	2002-1995
Chevrolet .....	2011-2004	Cadillac .....	2011-2010	Mazda .....	1999-1995	Land Rover .....	2004-1999
GMC .....	2011-2004	Chevrolet .....	2011-2004	Nissan .....	2001-1995	Lincoln .....	1997-1995
Hummer .....	2009-2004	GMC .....	2011-2004	Oldsmobile .....	1997-1995	Mazda .....	1999-1995
Isuzu .....	2008-2005	<b>10512</b>		Plymouth .....	2001-1995	Mercury .....	1999-1995
Pontiac .....	2009-2004	Hyundai .....	2011-2004	Pontiac .....	1997-1995	Mitsubishi .....	1997-1995
Saab .....	2009-2005	Infiniti .....	2011-2010	Subaru .....	2000-1995	Nissan .....	2001-1995
Saturn .....	2010-2003	Kia .....	2011-2004	Suzuki .....	1995	Oldsmobile .....	1997-1995
Suzuki .....	2009-2004	<b>10516</b>		Toyota .....	2010-1995	Plymouth .....	2001-1995
<b>10511Y</b>		Chevrolet .....	1998	Volkswagen .....	2010	Pontiac .....	1997-1995
Cadillac .....	2011-2010	Pontiac .....	1998	<b>10596</b>			
Chevrolet .....	2011-2004	<b>10517</b>		AM General .....	2001-1996	Subaru .....	2000-1995
GMC .....	2011-2004	Cadillac .....	2001-1999	Audi .....	2007	Suzuki .....	2004-1995
<b>10512</b>		<b>10518</b>		Cadillac .....	1998-1997	Toyota .....	2010-1995
Hyundai .....	2011-2004	Cadillac .....	2006-2005	Hummer .....	2006-2002	<b>10819D</b>	
Infiniti .....	2011-2010	Chevrolet .....	2006-2004	Mazda .....	1995	Chevrolet .....	2011-1995
Kia .....	2011-2004	GMC .....	2005-2004	Porsche .....	2010-1995	Dodge .....	1999-1995
<b>10516</b>		Saab .....	2007-2004	Saab .....	2000-1995	Ford .....	2008-1995
Chevrolet .....	1998	<b>10521</b>		Volkswagen .....	2010-2004	GMC .....	2011-1995
Pontiac .....	1998	Ford .....	2012-2010	<b>10597</b>			
<b>10517</b>		Jaguar .....	2008-2002	Audi .....	2010-2004	Subaru .....	2000-1995
Cadillac .....	2001-1999	Land Rover .....	2008-2005	Volkswagen .....	2011-2002	Volvo .....	1998-1995
<b>10518</b>		Mazda .....	2010-2004	<b>10810</b>			
Cadillac .....	2006-2005	Volvo .....	2011-2004	Audi .....	2010-2008	Chevrolet .....	1997-1995
Chevrolet .....	2006-2004	<b>10522</b>		BMW .....	1998-1995	Pontiac .....	1997-1995
GMC .....	2005-2004	Chevrolet .....	2003-1998	Mercedes-Benz .....	1995	Subaru .....	1995
Saab .....	2007-2004	GMC .....	2004-1998	<b>10817</b>			
<b>10516</b>		<b>10508</b>		Buick .....	1997-1995	Cadillac .....	1998-1997
Chevrolet .....	1998	Chrysler .....	2012-1999	Cadillac .....	1996-1995	Hummer .....	2006-2002
Pontiac .....	1998	Dodge .....	2012-1999	Chevrolet .....	1999-1995	<b>10826</b>	
<b>10517</b>		Ford .....	2012-2002	<b>10819</b>			
Cadillac .....	2001-1999	Jeep .....	2012-2000	Buick .....	1997-1995	Cadillac .....	1997-1995
<b>10518</b>		Mazda .....	2011-2003	Chevrolet .....	2011-1995	Chevrolet .....	2011-1995
Cadillac .....	2006-2005	Mercedes-Benz .....	2011-2006	Dodge .....	2002-1995	Dodge .....	2002-1995
Chevrolet .....	2006-2004	Mercury .....	2002-2000	Eagle .....	1998-1995	Eagle .....	1998-1995
GMC .....	2005-2004	Mitsubishi .....	2010-2001	Ford .....	2008-1995	Ford .....	2008-1995
Saab .....	2007-2004	Nissan .....	2012-2000	GMC .....	2011-1995	GMC .....	2011-1995
<b>10521</b>		<b>10508</b>		Infiniti .....	2000-1995	Infiniti .....	2000-1995
Ford .....	2012-2010	Chrysler ..					

## Cap Numerical Listing

Use as a Guide Only. Alphabetical Listing provides more detail.

Make	Year(s)	Make	Year(s)	Make	Year(s)
<b>10826 - Continued</b>		<b>10836 - Continued</b>		<b>10842 - Continued</b>	
Mazda .....	1995	Oldsmobile .....	2004-1996	Kia .....	2011-2004
Porsche .....	2010-1995	Pontiac .....	2005-1997	<b>10843</b>	
Saab .....	2000-1995	Saturn .....	2006-1998	BMW .....	2003-1997
Volkswagen .....	2010-2004	<b>10837</b>		Dodge .....	2006-2003
<b>10827</b>		Acura .....	2011-2004	Freightliner .....	2006-2003
Audi .....	2010-2004	Audi .....	2010	Mercedes-Benz .....	2008-1995
Volkswagen .....	2011-2002	Ford .....	2004-1998	<b>10844</b>	
<b>10830</b>		Honda .....	2011-2005	BMW .....	2011-1999
Chevrolet .....	2011-1995	Jaguar .....	2008-2002	Mini .....	2011-2002
GMC .....	2011-1996	Mercury .....	2000-1998	<b>10845</b>	
<b>10830D</b>		<b>10838</b>		Mercedes-Benz .....	2011-2000
Chevrolet .....	2011-1995	Chrysler .....	2012-1999	<b>10846</b>	
Dodge .....	1999-1995	Dodge .....	2012-1999	Chevrolet .....	1998
Ford .....	2008-1995	Ford .....	2011-2010	Pontiac .....	1998
GMC .....	2011-1995	Infiniti .....	2012-2002	<b>10847</b>	
<b>10832</b>		Jeep .....	2012-2000	Cadillac .....	2001-1999
Ford .....	2005-1996	Mazda .....	2011-2003	<b>10848</b>	
Lincoln .....	2006-1996	Mercedes-Benz .....	2011-2006	Cadillac .....	2006-2005
Mazda .....	2004-1998	Mercury .....	2002-2000	Chevrolet .....	2006-2004
Mercury .....	2005-1996	Mitsubishi .....	2010-2001	GMC .....	2005-2004
<b>10832D</b>		Nissan .....	2012-2000	Saab .....	2007-2004
Ford .....	2005-1997	Plymouth .....	2001-1999	<b>10851</b>	
<b>10832Y</b>		Subaru .....	2011-2005	Ford .....	2012-2010
Ford .....	2005-1996	Volkswagen .....	2011-2009	Jaguar .....	2008-2002
Mazda .....	2002-2000	<b>10838D</b>		Land Rover .....	2008-2005
Mercury .....	2004-2002	Dodge .....	2012-2000	Mazda .....	2010-2004
<b>10833</b>		Jeep .....	2009-2005	Volvo .....	2011-2004
Ford .....	2001-1996	Mercedes-Benz .....	2009-2007	<b>10838Y</b>	
Mercury .....	1997	<b>10839</b>		Chrysler .....	2012-1999
<b>10834</b>		Lexus .....	2009-2002	Dodge .....	2012-1999
Acura .....	2005-1995	Pontiac .....	2005	Jeep .....	2012-2007
Audi .....	2005-2002	Scion .....	2010-2005	Nissan .....	2011-2007
Buick .....	2011-1996	Toyota .....	2009-2002	Plymouth .....	2000-1999
Cadillac .....	2011-1999	<b>10840</b>		Volkswagen .....	2011
Chevrolet .....	2011-1995	Ford .....	2012-2004	<b>10839</b>	
Daewoo .....	2002-1999	Lincoln .....	2011-2004	Lexus .....	2009-2002
Dodge .....	2000	Mazda .....	2011-2004	Pontiac .....	2005
GMC .....	2011-1997	Mercury .....	2011-2004	Scion .....	2010-2005
Honda .....	2006-1995	<b>10840D</b>		Toyota .....	2009-2002
Hummer .....	2004-2003	Ford .....	2012-2004	<b>10840</b>	
Infiniti .....	2002-2001	Lincoln .....	2011-2004	Ford .....	2012-2004
Isuzu .....	2004-1995	Mazda .....	2011-2004	Lincoln .....	2011-2007
Lexus .....	2012-2000	Mercury .....	2011-2004	Mercury .....	2011-2004
Mazda .....	2011-1997	<b>10840Y</b>		<b>10841</b>	
Mercedes-Benz .....	2009-1998	Ford .....	2012-2004	Buick .....	2011-2004
Mitsubishi .....	2010-1997	Lincoln .....	2011-2007	Cadillac .....	2011-2004
Nissan .....	2011-2001	Mercury .....	2011-2004	Chevrolet .....	2011-2004
Oldsmobile .....	1997-1996	<b>10841</b>		GMC .....	2011-2004
Pontiac .....	2010-1995	Buick .....	2011-2004	Hummer .....	2009-2004
Saab .....	2006-1996	Cadillac .....	2011-2004	Isuzu .....	2008-2005
Scion .....	2012-2004	Chevrolet .....	2011-2004	Pontiac .....	2009-2004
Subaru .....	2011-2001	GMC .....	2011-2004	Saab .....	2009-2005
Suzuki .....	2011-2004	Hummer .....	2009-2004	Saturn .....	2010-2003
Toyota .....	2012-1999	Isuzu .....	2008-2005	Suzuki .....	2009-2004
Volkswagen .....	2010-2009	Pontiac .....	2009-2004	<b>10841Y</b>	
Volvo .....	2010-1998	Saab .....	2009-2005	Buick .....	2011-2010
<b>10834Y</b>		Saturn .....	2010-2003	Cadillac .....	2011-2010
Buick .....	2011	Suzuki .....	2009-2004	Chevrolet .....	2011-2004
Chevrolet .....	2011-2002	<b>10842</b>		GMC .....	2011-2004
GMC .....	2011-2002	Hyundai .....	2011-2004	<b>10835</b>	
Toyota .....	2012-2009	Infiniti .....	2011-2010	Audi .....	2011-1995
<b>10835</b>		<b>10841Y</b>		Volkswagen .....	2010-1995
Audi .....	2011-1995	Buick .....	2011-2010	<b>10836</b>	
Volkswagen .....	2010-1995	Cadillac .....	2011-2010	Buick .....	2005-1997
<b>10836</b>		Chevrolet .....	2011-2004	Cadillac .....	2005-1998
Buick .....	2005-1997	GMC .....	2011-2004	Chevrolet .....	2005-1996
Cadillac .....	2005-1998	<b>10842</b>		GMC .....	2005-1996
Chevrolet .....	2005-1996	Hyundai .....	2011-2004	Isuzu .....	2004-1997
GMC .....	2005-1996	Infiniti .....	2011-2010		
Isuzu .....	2004-1997				



## Thermostat Numerical Listing

Use as a Guide Only. Alphabetical Listing provides more detail.

Make	Year(s)	Make	Year(s)	Make	Year(s)	Make	Year(s)
<b>13006</b>		<b>13378 - Continued</b>		<b>13820</b>		<b>13879</b>	
Cadillac .....	1995	Volkswagen .....	2006-1995	Ford .....	1997-1995	Acura .....	2001-1995
Chevrolet .....	1996-1995	Volvo .....	2005-1995	Mazda .....	1997-1995	Honda .....	2011-1995
Dodge .....	2003-1995	<b>13379</b>		Mercury .....	1996-1995	Isuzu .....	2004
Ford .....	2008-1995	Jaguar .....	1996	<b>13828</b>		<b>13899</b>	
GMC .....	1996-1995	Lincoln .....	2011-2010	Ford .....	1997-1995	Buick .....	2007-1995
Jeep .....	2006-1995	Porsche .....	1995	Mazda .....	1997-1995	Chevrolet .....	2009-1995
Mazda .....	2009-1995	Volkswagen .....	2006-1995	Mercury .....	1996-1995	GMC .....	2007-1996
Mercury .....	2007-1995	Volvo .....	2005-1995	<b>13829</b>		Oldsmobile .....	2004-1995
<b>13008</b>		<b>13398</b>		Ford .....	1997-1995	Pontiac .....	2009-1995
Cadillac .....	1995	Ford .....	2002-1995	Mazda .....	1997-1995	Saturn .....	2006-2005
Chevrolet .....	1996-1995	Jaguar .....	1995	Mercury .....	1996-1995	<b>13918</b>	
Dodge .....	2003-1995	Lincoln .....	2003-1995	<b>13848</b>		Volvo .....	1995
Ford .....	2008-1995	Mercury .....	2001-1995	Buick .....	2009-1995	<b>13919</b>	
GMC .....	1996-1995	Saab .....	2008-1995	Chevrolet .....	2005-1995	Volvo .....	1995
Jeep .....	2006-1995	Volkswagen .....	1999	Geo .....	1997-1995	<b>13947</b>	
Mazda .....	2009-1995	Volvo .....	2003	GMC .....	2003-1995	Infiniti .....	2000-1995
Mercury .....	2007-1995	<b>13399</b>		Isuzu .....	2000-1996	Mercury .....	2002-1995
<b>13009</b>		Ford .....	2002-1995	Oldsmobile .....	1999-1995	Nissan .....	2004-1995
Cadillac .....	1995	Jaguar .....	1995	Pontiac .....	2007-1995	<b>13948</b>	
Chevrolet .....	1996-1995	Lincoln .....	2003-1995	Suzuki .....	2001-1995	Infiniti .....	2000-1995
Dodge .....	2003-1995	Mercury .....	2001-1995	<b>13849</b>		Mercury .....	2002-1995
Ford .....	2008-1995	Saab .....	2008-1995	Buick .....	2009-1995	Nissan .....	2004-1995
GMC .....	1996-1995	Volkswagen .....	1999	Chevrolet .....	2005-1995	<b>13958</b>	
Jeep .....	2006-1995	Volvo .....	2003	Geo .....	1997-1995	Chevrolet .....	1998
Mazda .....	2011-1995	<b>13479</b>		GMC .....	2003-1995	Ford .....	2000-1995
Mercury .....	2007-1995	Chevrolet .....	1999-1996	Isuzu .....	2000-1996	Geo .....	1997-1995
<b>13019</b>		GMC .....	1999-1996	Oldsmobile .....	1999-1995	Mazda .....	2000-1995
Chevrolet .....	2000-1999	<b>13496</b>		Pontiac .....	2008-1995	Pontiac .....	1997-1995
<b>13349</b>		Volkswwagen .....	2003	Suzuki .....	2001-1995	Suzuki .....	1998-1995
Chevrolet .....	2008-2004	<b>13588</b>		<b>13858</b>		<b>13959</b>	
<b>13352</b>		Audi .....	2008-1995	Ford .....	2008-1997	Chevrolet .....	1998
Cadillac .....	1995	BMW .....	2001-1995	Honda .....	1996-1995	Ford .....	2000-1995
Chevrolet .....	1996-1995	Mercedes-Benz .....	1999-1995	Isuzu .....	1997-1995	Geo .....	1997-1995
Dodge .....	2003-1995	<b>13648</b>		Mazda .....	2008-1999	Mazda .....	2000-1995
Ford .....	2003-1995	Audi .....	2001	Mercury .....	1999-1997	Pontiac .....	1997-1995
GMC .....	1996-1995	Ford .....	2010-1997	Subaru .....	2007-2005	Suzuki .....	1998-1995
Jeep .....	2005-2003	Jaguar .....	1997-1995	<b>13859</b>		<b>13967</b>	
Mazda .....	2009-1995	Mazda .....	2010-2002	Ford .....	2008-1997	Infiniti .....	1996-1995
<b>13356</b>		Mercury .....	2006-1998	Honda .....	1996-1995	Nissan .....	2007-1995
Cadillac .....	1995	Porsche .....	1995	Isuzu .....	1997-1995	<b>13968</b>	
Chevrolet .....	1996-1995	Volkswagen .....	2005-1995	Mazda .....	2008-1999	Infiniti .....	1996-1995
Dodge .....	2003-1995	<b>13649</b>		Mercury .....	1999-1997	Nissan .....	2007-1995
Ford .....	2003-1995	Audi .....	2001	Subaru .....	2007-2005	<b>13978</b>	
GMC .....	1996-1995	Ford .....	2011-1997	<b>13868</b>		Ford .....	2004-1995
Jeep .....	2005-2003	Jaguar .....	1997-1995	Chrysler .....	2000-1995	Mazda .....	2004-1995
Mazda .....	2009-1995	Mazda .....	2010-2001	Dodge .....	2000-1995	Mercury .....	2002-1995
<b>13358</b>		Mercury .....	2010-1998	Eagle .....	1996-1995	Toyota .....	1995
Cadillac .....	1995	Porsche .....	1995	Ford .....	1997-1995	<b>13979</b>	
Chevrolet .....	1996-1995	Volkswagen .....	2005-1995	Hyundai .....	1998-1995	Ford .....	2004-1995
Dodge .....	2003-1995	<b>13758</b>		Kia .....	2005-1995	Hyundai .....	1999-1998
Ford .....	2003-1995	Geo .....	1997-1995	Mazda .....	2005-1995	Mazda .....	2004-1995
GMC .....	1996-1995	Nissan .....	2003-1995	Mercury .....	1996-1995	Mercury .....	2002-1995
Jeep .....	2005-2003	Toyota .....	2001-1995	Mitsubishi .....	1998-1995	Toyota .....	1995
Mazda .....	2009-1995	<b>13778</b>		Plymouth .....	2000-1995	<b>14028</b>	
<b>13359</b>		Ford .....	2010-1996	Toyota .....	1995	Buick .....	1998-1995
Cadillac .....	1995	Lincoln .....	2011-1998	<b>13869</b>		Chevrolet .....	2002-1995
Chevrolet .....	1999-1995	Mercury .....	2011-2002	Chrysler .....	2000-1995	Oldsmobile .....	2001-1995
Dodge .....	2003-1995	<b>13779</b>		Dodge .....	2000-1995	Pontiac .....	2002-1995
Ford .....	2003-1995	Ford .....	2011-1996	Eagle .....	1996-1995	<b>14039</b>	
GMC .....	1999-1995	Lincoln .....	2011-1998	Ford .....	1997-1995	Chevrolet .....	1996-1995
Hyundai .....	2002-2000	Mercury .....	2011-2002	Hyundai .....	1998-1995	GMC .....	2000-1995
Jeep .....	2005-2003	<b>13788</b>		Kia .....	2005-1995	<b>14047</b>	
Mazda .....	2011-1995	Dodge .....	1995	Mazda .....	2005-1995	Ford .....	1997-1995
<b>13376</b>		Plymouth .....	1995	Mercury .....	1996-1995	Mazda .....	2003-1995
Jaguar .....	1996	<b>13789</b>		Mitsubishi .....	1998-1995	<b>14048</b>	
Porsche .....	1995	Dodge .....	1995	Plymouth .....	2000-1995	Ford .....	1997-1995
Volkswagen .....	2006-1995	Plymouth .....	1995	Toyota .....	1995	<b>13878</b>	
Volvo .....	2005-1995	Dodge .....	1995	Acura .....	2001-1995	<b>13879</b>	
<b>13378</b>		Porsche .....	1995	Honda .....	2010-1995	<b>13889</b>	
Jaguar .....	1996	<b>13878</b>		Isuzu .....	2004-1996	<b>13899</b>	
Porsche .....	1995	Acura .....	2001-1995	<b>13899</b>		Buick .....	2007-1995

## Thermostat Numerical Listing

Use as a Guide Only. Alphabetical Listing provides more detail.

Make	Year(s)	Make	Year(s)	Make	Year(s)	Make	Year(s)
<b>14048 - Continued</b>		<b>14139</b>		<b>14318</b>		<b>14598</b>	
Mazda .....	2003-1995	Ford .....	2011-1995	Infiniti .....	2010-1996	Mercedes-Benz .....	1999-1995
Suzuki .....	2008-1999	Jaguar .....	2006-2000	Nissan .....	2010-1995	<b>14602</b>	
<b>14068</b>		Lincoln .....	2009-2000	<b>14327</b>		BMW .....	2006-1999
Chevrolet .....	1995	Mazda .....	2008-2000	Acura .....	1999	<b>14612</b>	
<b>14077</b>		Mercury .....	2011-1995	Honda .....	2002-1998	BMW .....	2006-1996
Chevrolet .....	2002-1998	<b>14147</b>		Isuzu .....	2004-1998	<b>14622</b>	
Eagle .....	1998-1995	Subaru .....	2010-1995	<b>14337</b>		BMW .....	1999-1996
Ford .....	1999-1996	<b>14157</b>		Acura .....	2011-1996	<b>14632</b>	
Lexus .....	2009-1995	Subaru .....	1995	Honda .....	2011-1999	BMW .....	1999-1996
Mitsubishi .....	2009-1995	<b>14168</b>		<b>14349</b>		BMW .....	1999-1996
Pontiac .....	2007-2003	Mazda .....	1995	Chrysler .....	2010-1998	<b>14648</b>	
Scion .....	2009-2005	Mitsubishi .....	2011-1995	Dodge .....	2010-1998	Hyundai .....	2011-1996
Toyota .....	2010-1995	<b>14177</b>		Mitsubishi .....	2009	Kia .....	2011-2004
<b>14078</b>		Acura .....	1998-1996	<b>14358</b>		<b>14659</b>	
Chevrolet .....	2002-1998	Honda .....	1997-1995	Chrysler .....	2005-1998	Buick .....	2007-2004
Eagle .....	1998-1995	Isuzu .....	1997-1995	Dodge .....	2006-1998	Chevrolet .....	2009-2002
Ford .....	1999-1996	Toyota .....	2010-2008	Plymouth .....	2001-1999	GMC .....	2009-2002
Lexus .....	2011-1995	<b>14178</b>		<b>14369</b>		Isuzu .....	2007-2003
Mitsubishi .....	2009-1995	Acura .....	1998-1996	Chrysler .....	2009-2007	Oldsmobile .....	2004-2002
Pontiac .....	2007-2003	Honda .....	1997-1995	Dodge .....	2011-2000	Saab .....	2009-2007
Scion .....	2012-2005	Isuzu .....	1997-1995	Jeep .....	2010-1999	<b>14668</b>	
Toyota .....	2012-1995	<b>14188</b>		Mitsubishi .....	2008-2006	Infiniti .....	2008-2001
<b>14089</b>		BMW .....	1998-1995	<b>14378</b>		Nissan .....	2012-2001
Ford .....	2001-1996	<b>14209</b>		Chevrolet .....	2003-1999	<b>14678</b>	
Lincoln .....	2002-1995	Chrysler .....	2010-1995	Suzuki .....	2009-1996	Chrysler .....	2007
Mercury .....	2004-2003	Dodge .....	2010-1995	<b>14389</b>		Jeep .....	2008
<b>14099</b>		Eagle .....	1998-1995	Chrysler .....	2005-2001	Nissan .....	2011-2002
Audi .....	2006-1995	Jeep .....	2010-2002	Dodge .....	2005-2001	<b>14687</b>	
Volkswagen .....	2005-1998	Mini .....	2008-2002	Mitsubishi .....	2005-1999	Infiniti .....	1996-1995
<b>14108</b>		Mitsubishi .....	1999-1995	<b>14399</b>		<b>14698</b>	
Lexus .....	2005-1995	Plymouth .....	2001-1995	AM General .....	2001-1995	Buick .....	2012-2010
Scion .....	2006-2004	<b>14218</b>		Chevrolet .....	2002-1996	Chevrolet .....	2011-2002
Toyota .....	2010-1995	Buick .....	1996-1995	GMC .....	2002-1996	GMC .....	2011-2010
<b>14119</b>		Cadillac .....	1996-1995	Hummer .....	2004-2002	Oldsmobile .....	2004-2002
Cadillac .....	2000-1999	Chevrolet .....	1997-1995	<b>14419</b>		Pontiac .....	2010-2002
Chevrolet .....	2011-1996	Pontiac .....	1997-1995	Audi .....	2003-1997	Saab .....	2009-2005
GMC .....	2011-1996	<b>14228</b>		Volkswagen .....	2011-1998	Saturn .....	2010-2000
Isuzu .....	2000-1997	Buick .....	2011-2006	<b>14429</b>		<b>14707</b>	
Oldsmobile .....	2001-1996	Cadillac .....	2011-1995	AM General .....	1998-1995	Nissan .....	2006-2000
Volvo .....	2011	Oldsmobile .....	2003-1995	Chevrolet .....	1996-1995	<b>14719</b>	
<b>14127</b>		Pontiac .....	2005-2004	GMC .....	1996-1995	Mitsubishi .....	2011-2003
Acura .....	2005-1995	<b>14248</b>		<b>14536</b>		<b>14728</b>	
Chrysler .....	2005-1995	Dodge .....	1998-1995	BMW .....	2008-2006	Chevrolet .....	2011-2001
Dodge .....	2005-1995	<b>14252</b>		Dodge .....	2009-1995	GMC .....	2011-2001
Honda .....	2001-1995	Ford .....	1995	Ford .....	2006	<b>14738</b>	
Hyundai .....	2009-1999	<b>14269</b>		BMW .....	2008-2006	Chevrolet .....	2011-2001
Infiniti .....	2009-2003	Ford .....	2003-1996	Dodge .....	2009-1995	GMC .....	2011-2001
Kia .....	2009-2001	<b>14279</b>		Ford .....	2006	<b>14748</b>	
Lexus .....	2009-1996	Saab .....	1997-1995	<b>14538</b>		Ford .....	2003-2002
Mitsubishi .....	2010-1995	Saturn .....	2002-1995	BMW .....	2008-2006	Jaguar .....	2008-2000
Nissan .....	2011-2004	<b>14288</b>		Dodge .....	2009-1995	Lincoln .....	2003-2000
Toyota .....	2009-1995	Chrysler .....	2009-2008	Ford .....	2006	<b>14757</b>	
Volvo .....	2011-2005	Dodge .....	2009-1998	<b>14539</b>		Acura .....	2006-2002
<b>14128</b>		<b>14289</b>		BMW .....	2008-2006	Honda .....	2006-2002
Acura .....	2005-1995	Dodge .....	2010-1998	Dodge .....	2009-1995	<b>14768</b>	
Chrysler .....	2005-1995	<b>14298</b>		Ford .....	2006	Porsche .....	2009-1997
Dodge .....	2005-1995	Cadillac .....	2003-2002	<b>14569</b>		<b>14778</b>	
Honda .....	2001-1995	Chevrolet .....	2006-1997	Chrysler .....	2008-2004	Infiniti .....	2004-2002
Hyundai .....	2009-1999	GMC .....	2006-1999	Mercedes-Benz .....	2008-1998	Nissan .....	2009-2002
Infiniti .....	2010-2002	Hummer .....	2007-2003	<b>14578</b>		<b>14789</b>	
Kia .....	2010-2001	Isuzu .....	2003	Mercedes-Benz .....	1999-1995	Chrysler .....	2007-2001
Lexus .....	2010-1996	Pontiac .....	2002-1998	<b>14589</b>		Dodge .....	2006-2001
Mitsubishi .....	2011-1995	<b>14309</b>		Mercedes-Benz .....	2004-1995	<b>14798</b>	
Nissan .....	2011-2004	Cadillac .....	2004-1999	<b>14318</b>			
Toyota .....	2009-1995	Saturn .....	2005-2000	Infiniti .....	2010-1996		
Volvo .....	2011-2005	<b>14318</b>		Nissan .....	2010-1995		
<b>14138</b>		Ford .....	2011-1995	<b>14327</b>			
Ford .....	2011-1995	Jaguar .....	2006-2000	Acura .....	1999		
Jaguar .....	2006-2000	Lincoln .....	2011-2000	Honda .....	2002-1998		
Lincoln .....	2011-2000	Mazda .....	2010-2000	Isuzu .....	2004-1998		
Mazda .....	2010-2000	Mercury .....	2009-1995	<b>14337</b>			
Mercury .....	2009-1995	<b>14318</b>		Acura .....	2011-1996		
		Infiniti .....	2010-1996	Honda .....	2011-1999		
		Nissan .....	2010-1995	<b>14349</b>			
		<b>14318</b>		Chrysler .....	2010-1998		
		Ford .....	2011-1995	Dodge .....	2010-1998		
		Jaguar .....	2006-2000	Mitsubishi .....	2009		
		Lincoln .....	2009-2000	<b>14358</b>			
		Mazda .....	2008-2000	Chrysler .....	2005-1998		
		Mercury .....	2011-1995	Dodge .....	2006-1998		
		<b>14318</b>		Plymouth .....	2001-1999		
		Infiniti .....	2010-1996	<b>14369</b>			
		Nissan .....	2010-1995	Chrysler .....	2009-2007		
		<b>14318</b>		Dodge .....	2011-2000		
		Ford .....	2011-1995	Jeep .....	2010-1999		
		Jaguar .....	2006-2000	Mitsubishi .....	2008-2006		
		Lincoln .....	2009-2000	<b>14378</b>			
		Mazda .....	2008-2000	Chevrolet .....	2003-1999		
		Mercury .....	2011-1995	Suzuki .....	2009-1996		
		<b>14318</b>		<b>14389</b>			
		Infiniti .....	2010-1996	Chrysler .....	2005-2001		
		Nissan .....	2010-1995	Dodge .....	2005-2001		
		<b>14318</b>		Mitsubishi .....	2005-1999		
		Ford .....	2011-1995	<b>14399</b>			
		Jaguar .....	2006-2000	AM General .....	2001-1995		
		Lincoln .....	2011-2000	Chevrolet .....	2002-1996		
		Mazda .....	2010-2000	GMC .....	2002-1996		
		Mercury .....	2009-1995	Hummer .....	2004-2002		
		<b>14318</b>		<b>14419</b>			
		Infiniti .....	2010-1996	Audi .....	2003-1997		
		Nissan .....	2010-1995	Volkswagen .....	2011-1998		
		<b>14318</b>		<b>14429</b>			
		Ford .....	2011-1995	AM General .....	1998-1995		
		Jaguar .....	2006-2000	Chevrolet .....	1996-1995		
		Lincoln .....	2011-2000	GMC .....	1996-1995		
		Mazda .....	2010-2000	<b>14536</b>			
		Mercury .....	2009-1995	BMW .....	2008-2006		
		<b>14318</b>		Dodge .....	2009-1995		
		Infiniti .....	2010-1996	Ford .....	2006		
		Nissan .....	2010-1995	<b>14537</b>			
		<b>14318</b>		BMW .....	2008-2006		
		Ford .....	2011-1995	Dodge .....	2009-1995		
		Jaguar .....	2006-2000	Ford .....	2006		
		Lincoln .....	2011-2000	<b>14538</b>			
		Mazda .....	2010-2000	BMW .....	2008-2006		
		Mercury .....	2009-1995	Dodge .....	2009-1995		
		<b>14318</b>		Ford .....	2006		
		Infiniti .....	2010-1996	<b>14539</b>			
		Nissan .....	2010-1995	BMW .....	2008-2006		
		<b>14318</b>		Dodge .....	2009-1995		
		Ford .....	2011-1995	Ford .....	2006		
		Jaguar .....	2006-2000	<b>14569</b>			
		Lincoln .....	2011-2000	Chrysler .....	2008-2004		
		Mazda .....	2010-2000	Mercedes-Benz .....	2008-1998		
		Mercury .....	2009-1995	<b>14578</b>			
		<b>14318</b>		Mercedes-Benz .....	1999-1995		
		Infiniti .....	2010-1996	<b>14589</b>			
		Nissan .....	2010-1995	Mercedes-Benz .....	2004-1995		
		<b>14318</b>		<b>14598</b>			
		Ford .....	2011-1995	Mercedes-Benz .....	1999-1995		
		Jaguar .....	2006-2000	<b>14602</b>			
		Lincoln .....	2011-2000	BMW .....	2006-1999		
		Mazda .....	2010-2000	<b>14612</b>			
		Mercury .....	2009-1995	BMW .....	2006-1996		
		<b>14318</b>		<b>14622</b>			
		Infiniti .....	2010-1996	BMW .....	1999-1996		
		Nissan .....	2010-1995	<b>14632</b>			
		<b>14318</b>		BMW .....	1999-1996		
		Ford .....	2011-1995	<b>14648</b>			
		Jaguar .....	2006-2000	Hyundai .....	2011-1996		
		Lincoln .....	2011-2000	Kia .....	2011-2004		
		Mazda .....	2010-2000	<b>14659</b>			
		Mercury .....	2009-1995	Buick .....	2007-2004		
		<b>14318</b>		Chevrolet .....	2009-2002		
		Infiniti .....	2010-1996	GMC .....	2009-2002		
		Nissan .....	2010-1995	Isuzu .....	2007-2003		
		<b>14318</b>		Oldsmobile .....	2004-2002		
		Ford .....	2011-1995	Saab .....	2009-2007		
		Jaguar .....	2006-2000	<b>14668</b>			
		Lincoln .....	2011-2000	Infiniti .....	2008-2001		
		Mazda .....	2010-2000	Nissan .....	2012-2001		
		Mercury .....	2009-1995	<b>14678</b>			
		<b>14318</b>		Chrysler .....	2007		

## Thermostat Numerical Listing

Use as a Guide Only. Alphabetical Listing provides more detail.

Make	Year(s)	Make	Year(s)	Make	Year(s)	Make	Year(s)
<b>14798 - Continued</b>		<b>45359</b>		<b>45829</b>		<b>45899 - Continued</b>	
Oldsmobile .....	2002-1999	Cadillac .....	1995	Ford .....	1997-1995	Saturn .....	2006-2005
<b>14808</b>		Chevrolet .....	1999-1995	Mazda .....	1997-1995	<b>45947</b>	
Hyundai .....	2005-1999	Dodge .....	2003-1995	Mercury .....	1996-1995	Infiniti .....	2000-1995
Kia .....	2006-2001	Ford .....	2008-1995	<b>45848</b>		Mercury .....	2002-1995
<b>14818</b>		GMC .....	1999-1995	Buick .....	2009-1995	Nissan .....	2004-1995
Infiniti .....	2002-1999	Hyundai .....	2002-2000	Chevrolet .....	2005-1995	<b>45948</b>	
<b>14899</b>		Jeep .....	2006-1995	Geo .....	1997-1995	Infiniti .....	2000-1995
Ford .....	2010-2003	Mazda .....	2011-1995	GMC .....	2003-1995	Mercury .....	2002-1995
<b>14948</b>		Mercury .....	2007-1995	Isuzu .....	2000-1996	Nissan .....	2004-1995
Buick .....	2009-2004	Volkswagen .....	2010-2009	Oldsmobile .....	1999-1995	<b>45967</b>	
Cadillac .....	2007-2002	<b>45368</b>		Pontiac .....	2007-1995	Infiniti .....	1996-1995
Chevrolet .....	2011-1997	Ford .....	2000-1995	Suzuki .....	2001-1995	Nissan .....	2007-1995
GMC .....	2006-1999	Mazda .....	2000-1995	<b>45849</b>		<b>45978</b>	
Hummer .....	2007-2003	<b>45369</b>		Buick .....	2009-1995	Ford .....	2004-1995
Isuzu .....	2006-2003	Ford .....	2000-1995	Chevrolet .....	2005-1995	Mazda .....	2004-2001
Pontiac .....	2009-1998	Mazda .....	2000-1995	Geo .....	1997-1995	Mercury .....	2002-1995
Saab .....	2009-2006	<b>45378</b>		GMC .....	2003-1995	Toyota .....	1995
<b>14989</b>		Jaguar .....	1996	Isuzu .....	2000-1996	<b>45979</b>	
Ford .....	2008-1998	Porsche .....	1995	Oldsmobile .....	1999-1995	Ford .....	2004-1995
<b>14990</b>		Volkswagen .....	2006-1995	Pontiac .....	2008-1995	Mazda .....	2004-2001
Ford .....	2004-1997	Volvo .....	2005-1995	Suzuki .....	2001-1995	Mercury .....	2002-1995
Mazda .....	2001-1998	<b>45379</b>		<b>45858</b>		Toyota .....	1995
Mercury .....	1999-1997	Jaguar .....	1996	Honda .....	1996-1995	<b>45990</b>	
<b>15112</b>		Porsche .....	1995	Isuzu .....	1997-1995	Ford .....	2004-1997
Infiniti .....	2010-2002	Volkswagen .....	2006-1995	Subaru .....	2007-2005	Mazda .....	2001-1998
Nissan .....	2011-2002	Volvo .....	2005-1995	<b>45859</b>		<b>48019</b>	
<b>45028</b>		<b>45398</b>		Honda .....	1996-1995	Mercedes-Benz .....	1999-1995
Buick .....	1998-1995	Ford .....	2002-1995	Isuzu .....	1997-1995	<b>48028</b>	
Chevrolet .....	2002-1995	Jaguar .....	1995	Subaru .....	2007-2005	Chevrolet .....	1998
Oldsmobile .....	2001-1995	Lincoln .....	2003-1995	<b>45868</b>		Pontiac .....	1997-1995
Pontiac .....	2002-1995	Mercury .....	2001-1995	Chrysler .....	2000-1995	Suzuki .....	1998-1995
<b>45119</b>		Saab .....	2008-1995	Dodge .....	2000-1995	<b>48049</b>	
Cadillac .....	2000-1999	Volkswagen .....	1999	Eagle .....	1996-1995	Audi .....	2006-1995
Chevrolet .....	2011-1996	Volvo .....	2003	Ford .....	1997-1995	Volkswagen .....	2000-1998
GMC .....	2011-1996	<b>45399</b>		Hyundai .....	1998-1995	<b>48078</b>	
Isuzu .....	2000-1997	Ford .....	2002-1995	Kia .....	1998-1995	Volvo .....	1995
Oldsmobile .....	2001-1996	Jaguar .....	1995	Mazda .....	2005-1995	<b>48099</b>	
Volvo .....	2011	Lincoln .....	2003-1995	Mercury .....	1996-1995	Mazda .....	2008-2004
<b>45209</b>		Mercury .....	2001-1995	Mitsubishi .....	1998-1995	<b>48109</b>	
Chrysler .....	2010-1995	Saab .....	2008-1995	Plymouth .....	2000-1995	Mazda .....	2004-2001
Dodge .....	2010-1995	Volkswagen .....	1999	Toyota .....	1995	<b>48118</b>	
Eagle .....	1998-1995	Volvo .....	2003	<b>45869</b>		Toyota .....	2004-1995
Jeep .....	2010-2002	<b>45758</b>		Chrysler .....	2000-1995	<b>48128</b>	
Mitsubishi .....	1999-1995	Geo .....	1997-1995	Dodge .....	2000-1995	Chevrolet .....	2000
Plymouth .....	2001-1995	Nissan .....	2003-1995	Eagle .....	1996-1995	Lexus .....	2011-1995
<b>45218</b>		Toyota .....	2001-1995	Ford .....	1997-1995	Pontiac .....	2003
Buick .....	1996-1995	<b>45778</b>		Hyundai .....	1998-1995	Scion .....	2012-2005
Cadillac .....	1996-1995	Ford .....	2010-1996	Kia .....	2005-1995	Toyota .....	2011-1995
Chevrolet .....	1997-1995	Lincoln .....	2011-1998	Mazda .....	2005-1995	<b>48138</b>	
Pontiac .....	1997-1995	Mercury .....	2011-2002	Mercury .....	1996-1995	Infiniti .....	2000-1997
<b>45356</b>		<b>45779</b>		Mitsubishi .....	1998-1995	Nissan .....	2004-1998
Cadillac .....	1995	Ford .....	2011-1996	Plymouth .....	2000-1995	<b>48148</b>	
Chevrolet .....	1996-1995	Lincoln .....	2011-1998	Toyota .....	1995	Toyota .....	1998-1995
Dodge .....	2003-1995	Mercury .....	2011-2002	<b>45877</b>		<b>48158</b>	
Ford .....	2008-1995	<b>45788</b>		Acura .....	2005-1995	Acura .....	2001-1995
GMC .....	1996-1995	Dodge .....	1995	Honda .....	2010-1995	Honda .....	1998-1995
Jeep .....	2006-1995	Plymouth .....	1995	Isuzu .....	2004	<b>48168</b>	
Mazda .....	2009-1995	<b>45789</b>		<b>45878</b>		Eagle .....	1998-1995
Mercury .....	2007-1995	Dodge .....	1995	Acura .....	2005-1995	Mitsubishi .....	2010-1995
<b>45358</b>		Plymouth .....	1995	Honda .....	2010-1995	<b>48177</b>	
Cadillac .....	1995	<b>45820</b>		Isuzu .....	2004-1996	Nissan .....	1996-1995
Chevrolet .....	1996-1995	Ford .....	1997-1995	<b>45879</b>		<b>48197</b>	
Dodge .....	2003-1995	Mazda .....	1997-1995	Acura .....	2005-1995		
Ford .....	2008-1995	Mercury .....	1996-1995	Honda .....	2011-1995		
GMC .....	1996-1995	<b>45828</b>		Isuzu .....	2004		
Jeep .....	2006-1995	Ford .....	1997-1995	<b>45899</b>			
Mazda .....	2009-1995	Mazda .....	1997-1995	Buick .....	2007-1995		
Mercury .....	2007-1995	Mazda .....	1997-1995	Chevrolet .....	2009-1995		
		Mercury .....	1996-1995	GMC .....	2007-1996		
		Volvo .....	2005-1995	Oldsmobile .....	2004-1995		
				Pontiac .....	2006-1995		

## Thermostat Numerical Listing

Use as a Guide Only. Alphabetical Listing provides more detail.

Make	Year(s)	Make	Year(s)	Make	Year(s)
<b>48197 - Continued</b>		<b>48529 - Continued</b>		<b>48808</b>	
Infiniti .....	1997-1995	Suzuki .....	2001-1995	Buick .....	2011-2006
<b>48217</b>		<b>48588</b>		Chevrolet .....	2011-2006
Dodge .....	1996-1995	Hyundai .....	2011-1996	Pontiac .....	2010-2006
Mitsubishi .....	1999-1995	Kia .....	2011-2004	Saturn .....	2009-2006
<b>48227</b>		<b>48597</b>		<b>48818</b>	
Acura .....	2011-1995	Subaru .....	1995	Cadillac .....	2010-2004
Honda .....	2011-1995	<b>48608</b>		<b>48829</b>	
<b>48239</b>		Mazda .....	2005-1995	Mercedes-Benz .....	2005-2003
Chrysler .....	2005-2001	<b>48628</b>		<b>48839</b>	
Dodge .....	2005-2001	Buick .....	2012-2010	Volvo .....	2005-2000
Mitsubishi .....	2005-1999	Chevrolet .....	2011-2002	<b>49099</b>	
<b>48247</b>		GMC .....	2011-2010	Audi .....	2010-2005
Isuzu .....	2004-1998	Oldsmobile .....	2004-2002	<b>49108</b>	
<b>48258</b>		Pontiac .....	2010-2002	Chrysler .....	2010-2006
Infiniti .....	2002-1999	Saab .....	2009	Dodge .....	2010-2007
<b>48268</b>		Saturn .....	2010-2000	<b>49200</b>	
Hyundai .....	2005-1999	<b>48639</b>		Ford .....	2010-2008
Kia .....	2006-2001	Volvo .....	2004-1995		
<b>48278</b>		<b>48648</b>			
Toyota .....	2001-1995	BMW .....	2000-1995		
<b>48288</b>		<b>48658</b>			
Toyota .....	1995	Mercedes-Benz .....	1999-1995		
<b>48298</b>		<b>48668</b>			
Lexus .....	2000-1998	Volkswagen .....	2005-1995		
<b>48308</b>		<b>48672</b>			
Lexus .....	2005-1995	Ford .....	2011-2001		
Scion .....	2006-2004	Mazda .....	2003-2001		
Toyota .....	2011-1995	<b>48689</b>			
<b>48319</b>		Ford .....	2011-2005		
Toyota .....	1995	Mazda .....	2011-2004		
<b>48327</b>		Mercury .....	2007-2005		
Toyota .....	1999-1998	<b>48708</b>			
<b>48349</b>		Ford .....	2011-2003		
Saab .....	2008-2000	Mazda .....	2009-2007		
<b>48358</b>		Mercury .....	2011-2006		
Mazda .....	1995	<b>48718</b>			
<b>48368</b>		Chevrolet .....	2011-2004		
Nissan .....	2003-1995	GMC .....	2010-2004		
<b>48418</b>		Hummer .....	2009-2006		
Toyota .....	2004-1995	Isuzu .....	2008-2006		
<b>48438</b>		<b>48728</b>			
Mazda .....	1995	Mazda .....	2010-2003		
<b>48447</b>		<b>48732</b>			
Infiniti .....	1996-1995	Audi .....	2006-2002		
Nissan .....	2007-1995	<b>48747</b>			
<b>48457</b>		Acura .....	2008-2004		
Saab .....	2006-2005	Honda .....	2011-2006		
Subaru .....	2010-1995	<b>48759</b>			
<b>48469</b>		Cadillac .....	2004-1999		
Hyundai .....	1999-1995	Saturn .....	2005-2000		
<b>48478</b>		<b>48767</b>			
Mazda .....	2011-1995	Acura .....	2011-2009		
<b>48487</b>		Honda .....	2011-2003		
Honda .....	2002-1998	<b>48778</b>			
<b>48499</b>		Toyota .....	2011-2003		
Volkswagen .....	2006-1998	<b>48788</b>			
Volvo .....	2005	Jaguar .....	2007-2002		
<b>48529</b>		<b>48792</b>			
Chevrolet .....	1999	Chrysler .....	2010-2005		
		Dodge .....	2011-2003		
		Jeep .....	2010-2005		

# OIL FILLER CAP NUMERICAL LISTING

Use as a guide only. Refer to application section for specific vehicle.

<p><b>10061</b></p>  <p>3<sup>9</sup>/<sub>64</sub>"</p> <p>1<sup>7</sup>/<sub>8</sub>"</p>	<p><b>10072</b></p>  <p>1<sup>59</sup>/<sub>64</sub>"</p> <p>1<sup>3</sup>/<sub>16</sub>"</p> <p>1<sup>9</sup>/<sub>32</sub>"</p>	<p><b>10079</b></p>  <p>2<sup>17</sup>/<sub>32</sub>"</p> <p>1<sup>21</sup>/<sub>64</sub>"</p> <p>1<sup>31</sup>/<sub>64</sub>"</p>
<p><b>10064</b></p>  <p>3<sup>9</sup>/<sub>64</sub>"</p> <p>2"</p> <p>1<sup>5</sup>/<sub>32</sub>"</p>	<p><b>10075 CRANKCASE BREATHER CAP</b></p>  <p>3<sup>3</sup>/<sub>64</sub>"</p> <p>2<sup>53</sup>/<sub>64</sub>"</p> <p>1<sup>1</sup>/<sub>16</sub>"</p>	<p><b>10080 M 37 x 3 THREAD</b></p>  <p>2<sup>1</sup>/<sub>2</sub>"</p> <p>1<sup>1</sup>/<sub>4</sub>"</p> <p>1<sup>15</sup>/<sub>32</sub>"</p>
<p><b>10066</b></p>  <p>3"</p> <p>1"</p> <p>1<sup>3</sup>/<sub>16</sub>"</p>	<p><b>10076</b></p>  <p>2<sup>15</sup>/<sub>32</sub>"</p> <p>2<sup>15</sup>/<sub>16</sub>"</p> <p>1<sup>5</sup>/<sub>32</sub>"</p>	<p><b>10081 M 32 x 3.5 THREAD</b></p>  <p>2<sup>1</sup>/<sub>2</sub>"</p> <p>1<sup>1</sup>/<sub>4</sub>"</p> <p>1<sup>1</sup>/<sub>4</sub>"</p>
<p><b>10070</b></p>  <p>3<sup>3</sup>/<sub>4</sub>"</p> <p>1<sup>59</sup>/<sub>64</sub>"</p> <p>FITS 1<sup>1</sup>/<sub>2</sub>" FILLER TUBE</p> <p>FITS 5/8" I.D. TUBING</p>	<p><b>10077</b></p>  <p>2<sup>17</sup>/<sub>64</sub>"</p> <p>1<sup>21</sup>/<sub>64</sub>"</p> <p>1<sup>11</sup>/<sub>64</sub>"</p>	<p><b>10082 M 35 x 4 THREAD</b></p>  <p>2<sup>1</sup>/<sub>2</sub>"</p> <p>1<sup>1</sup>/<sub>4</sub>"</p> <p>1<sup>3</sup>/<sub>8</sub>"</p>
<p><b>10071</b></p>  <p>3<sup>11</sup>/<sub>64</sub>"</p> <p>1" DIA. HOLE</p> <p>2<sup>9</sup>/<sub>64</sub>"</p> <p>1<sup>5</sup>/<sub>32</sub>"</p>	<p><b>10078 CRANKCASE BREATHER CAP</b></p>  <p>2<sup>41</sup>/<sub>64</sub>"</p> <p>2<sup>9</sup>/<sub>64</sub>"</p> <p>1<sup>3</sup>/<sub>64</sub>"</p>	<p><b>10083 MOGUL THREAD</b></p>  <p>2<sup>1</sup>/<sub>2</sub>"</p> <p>1<sup>1</sup>/<sub>4</sub>"</p> <p>1<sup>35</sup>/<sub>64</sub>"</p>

# OIL FILLER CAP NUMERICAL LISTING (Continued)

Use as a guide only. Refer to application section for specific vehicle.

<p><b>10084</b></p> <p>39/16" 17/64" 127/64"</p>	<p><b>10090</b></p> <p>23 1/32" 17/8"</p>	<p><b>10096</b></p> <p>2 11/32" 1 7/32" 1 19/64"</p>
<p><b>10085</b></p> <p>1 3/4" 1 1/8" 1 1/16"</p>	<p><b>10092</b></p> <p>Ø59.94mm 24.66mm Ø40.48mm</p>	<p><b>10097</b></p> <p>23/32" 1 1/32" 1 11/64"</p>
<p><b>10086</b></p> <p>2 13/32" 3 1/4" 1 11/64"</p>	<p><b>10093</b></p> <p>Ø54.99mm 11.94mm Ø52.78mm</p>	<p><b>10098</b></p> <p>2" 2 19/64" 1 1/2"</p>
<p><b>10087</b></p> <p>27/16" 1 1/32" 1 11/64"</p>	<p><b>10094</b></p> <p>1 25/32" 1 3/8" 1 19/32" Hose Length 13 3/8"</p>	<p><b>10099</b></p> <p>2 15/32" 1 1/2" 1 17/32"</p>
<p><b>10088</b></p> <p>2 59/64" 1 13/32"</p>	<p><b>10095</b></p> <p>1 29/64" 1 1/4" 1 3/8"</p>	<p><b>10100</b></p> <p>2 3/4" 1 5/8" 1 15/64"</p>

# OIL FILLER CAP NUMERICAL LISTING (Continued)

Use as a guide only. Refer to application section for specific vehicle.

<p><b>10101</b></p>  <p>Dimensions: <math>2\frac{3}{8}</math>" (width), <math>1\frac{5}{16}</math>" (height), <math>1\frac{9}{32}</math>" (base width)</p>	<p><b>10106</b></p>  <p>Dimensions: <math>2\frac{29}{32}</math>" (width), <math>1\frac{11}{16}</math>" (height), <math>1\frac{15}{32}</math>" (base width)</p>	<p><b>10111</b></p>  <p>Dimensions: <math>2\frac{11}{32}</math>" (width), <math>1\frac{7}{16}</math>" (height), <math>1\frac{15}{64}</math>" (base width)</p>
<p><b>10102</b></p>  <p>Dimensions: <math>2\frac{3}{4}</math>" (width), <math>1\frac{19}{64}</math>" (height), <math>1\frac{13}{32}</math>" (base width)</p>	<p><b>10107</b></p>  <p>Dimensions: <math>2\frac{11}{32}</math>" (width), <math>1\frac{3}{16}</math>" (height), <math>1\frac{15}{64}</math>" (base width)</p>	<p><b>10112</b></p>  <p>Dimensions: <math>2\frac{5}{8}</math>" (width), <math>1\frac{11}{32}</math>" (height), <math>1\frac{15}{16}</math>" (base width)</p>
<p><b>10103</b></p>  <p>Dimensions: <math>2\frac{5}{16}</math>" (width), <math>1\frac{11}{16}</math>" (height), <math>1\frac{13}{16}</math>" (base width)</p>	<p><b>10108</b></p>  <p>Dimensions: <math>2\frac{53}{64}</math>" (width), <math>1\frac{45}{64}</math>" (height), <math>1\frac{25}{32}</math>" (base width)</p>	<p><b>10113</b></p>  <p>Dimensions: <math>2\frac{3}{8}</math>" (width), <math>1\frac{25}{32}</math>" (height), <math>1\frac{9}{32}</math>" (base width)</p>
<p><b>10104</b></p>  <p>Dimensions: <math>2\frac{23}{64}</math>" (width), <math>1\frac{11}{32}</math>" (height), <math>1\frac{9}{32}</math>" (base width)</p>	<p><b>10109</b></p>  <p>Dimensions: <math>2\frac{11}{32}</math>" (width), <math>1</math>" (height), <math>1\frac{23}{64}</math>" (base width)</p>	<p><b>10114</b></p>  <p>Dimensions: <math>2\frac{3}{8}</math>" (width), <math>1\frac{7}{16}</math>" (height), <math>1\frac{19}{64}</math>" (base width)</p>
<p><b>10105</b></p>  <p>Dimensions: <math>2\frac{11}{32}</math>" (width), <math>1\frac{11}{32}</math>" (height), <math>1\frac{9}{32}</math>" (base width)</p>	<p><b>10110</b></p>  <p>Dimensions: <math>2\frac{11}{32}</math>" (width), <math>1\frac{15}{64}</math>" (height), <math>1\frac{5}{8}</math>" (base width)</p>	<p><b>10115</b></p>  <p>Dimensions: <math>2\frac{21}{32}</math>" (width), <math>1\frac{3}{32}</math>" (height), <math>1\frac{3}{16}</math>" (base width)</p>

# OIL FILLER CAP NUMERICAL LISTING (Continued)

Use as a guide only. Refer to application section for specific vehicle.

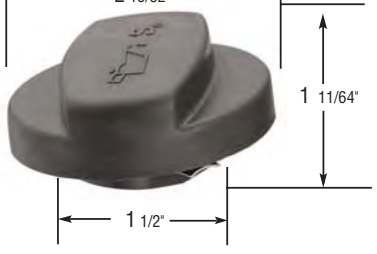
<p><b>10116</b></p>  <p>Dimensions: <math>2\frac{21}{32}</math>" (width), <math>22\frac{11}{32}</math>" (height)</p>	<p><b>10121</b></p>  <p>Dimensions: <math>2\frac{15}{32}</math>" (width), <math>1\frac{17}{64}</math>" (height), <math>1\frac{13}{16}</math>" (width)</p>	<p><b>10126</b></p>  <p>Dimensions: <math>2\frac{1}{32}</math>" (width), <math>20\frac{3}{8}</math>" (height)</p>
<p><b>10117</b></p>  <p>Dimensions: <math>2\frac{11}{32}</math>" (width), <math>1\frac{15}{32}</math>" (height), <math>1\frac{13}{32}</math>" (width)</p>	<p><b>10122</b></p>  <p>Dimensions: <math>2\frac{3}{8}</math>" (width), <math>21\frac{3}{8}</math>" (height)</p>	<p><b>10127</b></p>  <p>Dimensions: <math>2\frac{23}{64}</math>" (width), <math>22\frac{3}{4}</math>" (height)</p>
<p><b>10118</b></p>  <p>Dimensions: <math>2\frac{11}{32}</math>" (width), <math>1\frac{21}{32}</math>" (height), <math>1\frac{13}{32}</math>" (width)</p>	<p><b>10123</b></p>  <p>Dimensions: <math>2\frac{11}{32}</math>" (width), <math>21\frac{7}{8}</math>" (height)</p>	<p><b>10128</b></p>  <p>Dimensions: <math>2\frac{3}{8}</math>" (width), <math>24</math>" (height)</p>
<p><b>10119</b></p>  <p>Dimensions: <math>2\frac{11}{32}</math>" (width), <math>1\frac{3}{4}</math>" (height), <math>1\frac{21}{64}</math>" (width)</p>	<p><b>10124</b></p>  <p>Dimensions: <math>2\frac{3}{8}</math>" (width), <math>20</math>" (height)</p>	<p><b>10129</b></p>  <p>Dimensions: <math>2\frac{49}{64}</math>" (width), <math>1\frac{3}{32}</math>" (height), <math>1\frac{21}{32}</math>" (width)</p>
<p><b>10120</b></p>  <p>Dimensions: <math>3\frac{1}{4}</math>" (width), <math>2\frac{27}{64}</math>" (height), <math>2\frac{45}{64}</math>" (width)</p>	<p><b>10125</b></p>  <p>Dimensions: <math>2\frac{23}{64}</math>" (width), <math>28\frac{3}{8}</math>" (height)</p>	<p><b>10130</b></p>  <p>Dimensions: <math>2\frac{15}{32}</math>" (width), <math>1\frac{11}{64}</math>" (height), <math>1\frac{1}{2}</math>" (width)</p>



# OIL FILLER CAP NUMERICAL LISTING (Continued)

Use as a guide only. Refer to application section for specific vehicle.

<p><b>10131</b></p>  <p>3 19/64" 1 1/32" 1 1/2"</p>	<p><b>10136</b></p>  <p>1 7/8" 1 17/64" 1 3/16"</p>	<p><b>10142</b></p>  <p>3 5/32" 1 17/32" 1 21/32"</p>
<p><b>10132</b></p>  <p>2 11/32" 1 27/32" 1 5/16"</p>	<p><b>10137</b></p>  <p>2 17/64" 1 27/32" 1 7/32"</p>	<p><b>10143</b></p>  <p>2 15/32" 1 1/2" 1 23/64"</p>
<p><b>10133</b></p>  <p>2 1/2" 2 7/8" 1 3/8"</p>	<p><b>10138</b></p>  <p>2 9/16" 1 11/32" 1 7/16"</p>	<p><b>10144</b></p>  <p>1 3/4" 1 27/64" 1 21/64"</p>
<p><b>10134</b></p>  <p>2 13/64" 1 23/64" 1 1/4"</p>	<p><b>10140</b></p>  <p>2 23/64" 1 7/64" 1 51/64"</p>	<p><b>10145</b></p>  <p>3 39/64" 2 3/8" 2 23/32"</p>
<p><b>10135</b></p>  <p>2 13/64" 1 1/4" 1 15/32"</p>	<p><b>10141</b></p>  <p>2 3/8" 2 3/32" 1 11/32"</p>	<p><b>10146</b></p>  <p>2 63/64" 26 1/2"</p>

# OIL FILLER CAP NUMERICAL LISTING (Continued)

Use as a guide only. Refer to application section for specific vehicle.

<p><b>10147</b></p>  <p>2 3/4" 1 45/64" 1 15/32"</p>	<p><b>10151</b></p>  <p>1.50"</p>	<p><b>10155</b></p>  <p>2.00"</p>
<p><b>10148</b></p>  <p>1 23/32" 1 17/64" 1 13/64"</p>	<p><b>10152</b></p>  <p>1.375"</p>	<p><b>10156</b></p>  <p>2.25"</p>
<p><b>10149</b></p>  <p>1.00"</p>	<p><b>10153</b></p>  <p>1.75"</p>	<p><b>10157</b></p>  <p>2.50"</p>
<p><b>10150</b></p>  <p>1.25"</p>	<p><b>10154</b></p>  <p>1.625"</p>	



# RADIATOR CAP NUMERICAL LISTING

Use as a guide only. Refer to application section for specific vehicle.

<p><b>10203</b></p>  <p>3 <sup>9</sup>/<sub>64</sub>"</p> <p>1 <sup>1</sup>/<sub>32</sub>"</p>	<p><b>10227 13 LBS.</b></p>  <p>2 <sup>19</sup>/<sub>32</sub>"</p> <p>1 <sup>1</sup>/<sub>16</sub>"</p> <p>FOR RADIATOR OVERFLOW RESERVOIR SYSTEMS FITS 32 MM I.D., 16 MM DEEP NECK</p>	<p><b>10233 16 LBS.</b></p>  <p>2 <sup>19</sup>/<sub>32</sub>"</p> <p>1 <sup>1</sup>/<sub>16</sub>"</p> <p>FOR RADIATOR OVERFLOW RESERVOIR SYSTEMS FITS 32 MM I.D., 16 MM DEEP NECK</p>
<p><b>10205</b></p>  <p>3 <sup>7</sup>/<sub>64</sub>"</p> <p>1 <sup>13</sup>/<sub>32</sub>"</p>	<p><b>10228 7 LBS.</b></p>  <p>2 <sup>21</sup>/<sub>64</sub>"</p> <p>1 <sup>13</sup>/<sub>64</sub>"</p> <p>FOR RADIATOR OVERFLOW RESERVOIR SYSTEMS FITS 3/4" DEEP NECK</p>	<p><b>10234 18 LBS.</b></p>  <p>2 <sup>21</sup>/<sub>64</sub>"</p> <p>1 <sup>13</sup>/<sub>64</sub>"</p> <p>FOR RADIATOR OVERFLOW RESERVOIR SYSTEMS FITS 3/4" DEEP NECK</p>
<p><b>10206</b></p>  <p>2 <sup>21</sup>/<sub>64</sub>"</p> <p>1 <sup>13</sup>/<sub>32</sub>"</p>	<p><b>10229 13 LBS.</b></p>  <p>2 <sup>21</sup>/<sub>64</sub>"</p> <p>1 <sup>13</sup>/<sub>64</sub>"</p> <p>FOR RADIATOR OVERFLOW RESERVOIR SYSTEMS FITS 3/4" DEEP NECK</p>	<p><b>10235 20 LBS.</b></p>  <p>2 <sup>21</sup>/<sub>64</sub>"</p> <p>1 <sup>13</sup>/<sub>64</sub>"</p> <p>FOR RADIATOR OVERFLOW RESERVOIR SYSTEMS FITS 3/4" DEEP NECK</p>
<p><b>10208</b></p>  <p>3 <sup>1</sup>/<sub>8</sub>"</p> <p>1 <sup>5</sup>/<sub>32</sub>"</p>	<p><b>10230 16 LBS.</b></p>  <p>2 <sup>21</sup>/<sub>64</sub>"</p> <p>1 <sup>13</sup>/<sub>64</sub>"</p> <p>FOR RADIATOR OVERFLOW RESERVOIR SYSTEMS FITS 3/4" DEEP NECK</p>	<p><b>10236</b></p>  <p>3 <sup>1</sup>/<sub>32</sub>"</p> <p>1 <sup>29</sup>/<sub>32</sub>"</p> <p>COOLANT RECOVERY BOTTLE CAP</p>
<p><b>10225 20 LBS.</b></p>  <p>2 <sup>17</sup>/<sub>64</sub>"</p> <p>1"</p> <p>FITS THREADED FILLER NECK</p>	<p><b>10231 16 LBS. VENTED</b></p>  <p>2 <sup>21</sup>/<sub>64</sub>"</p> <p>1 <sup>13</sup>/<sub>64</sub>"</p> <p>FOR RADIATOR OVERFLOW RESERVOIR SYSTEMS FITS 3/4" DEEP NECK</p>	<p><b>10237 10 LBS.</b></p>  <p>2 <sup>21</sup>/<sub>64</sub>"</p> <p>1 <sup>13</sup>/<sub>64</sub>"</p> <p>FOR RADIATOR OVERFLOW RESERVOIR SYSTEMS FITS 3/4" DEEP NECK</p>
<p><b>10226 15 LBS.</b> NO VACUUM RELIEF</p>  <p>2 <sup>11</sup>/<sub>32</sub>"</p> <p>1 <sup>1</sup>/<sub>4</sub>"</p> <p>FOR RADIATOR OVERFLOW RESERVOIR SYSTEMS FITS 3/4" DEEP NECK</p>	<p><b>10232</b></p>  <p>2 <sup>55</sup>/<sub>64</sub>"</p> <p>25/64"</p> <p>THERMOSTAT HOUSING CAP</p>	<p><b>10238 16 LBS.</b></p>  <p>3 <sup>19</sup>/<sub>64</sub>"</p> <p>1 <sup>19</sup>/<sub>64</sub>"</p> <p>FITS THREADED FILLER NECK</p>

# RADIATOR CAP NUMERICAL LISTING (Continued)

Use as a guide only. Refer to application section for specific vehicle.

<p><b>10239 15 LBS.</b></p>  <p><b>FITS THREADED FILLER NECK</b></p>	<p><b>10245 11 LBS.</b></p>  <p><b>FITS THREADED FILLER NECK</b></p>	<p><b>10251 17 LBS.</b></p>  <p><b>FITS THREADED FILLER NECK</b></p>
<p><b>10240 15 LBS.</b></p>  <p><b>FITS THREADED FILLER NECK</b></p>	<p><b>10246 20 LBS.</b></p>  <p><b>FITS THREADED FILLER NECK</b></p>	<p><b>10252 15 LBS.</b></p>  <p><b>FITS THREADED FILLER NECK</b></p>
<p><b>10241 13 LBS.</b></p>  <p><b>FOR RADIATOR OVERFLOW RESERVOIR SYSTEMS FITS 31 MM I.D., 10 MM DEEP NECK</b></p>	<p><b>10247 30 LBS.</b></p>  <p><b>FITS THREADED FILLER NECK</b></p>	<p><b>10253 21 LBS.</b></p>  <p><b>FITS THREADED FILLER NECK</b></p>
<p><b>10242 16 LBS.</b></p>  <p><b>FOR RADIATOR OVERFLOW RESERVOIR SYSTEMS FITS 31 MM I.D., 10 MM DEEP NECK</b></p>	<p><b>10248 15 LBS.</b></p>  <p><b>FITS THREADED FILLER NECK</b></p>	<p><b>10254 19 LBS.</b></p>  <p><b>FITS THREADED FILLER NECK</b></p>
<p><b>10243 20 LBS.</b></p>  <p><b>FITS THREADED FILLER NECK</b></p>	<p><b>10249 22 LBS.</b></p>  <p><b>FITS THREADED FILLER NECK</b></p>	<p><b>10255 18 LBS.</b></p>  <p><b>FITS THREADED FILLER NECK</b></p>
<p><b>10244 22 LBS.</b></p>  <p><b>FITS THREADED FILLER NECK</b></p>	<p><b>10250 18 LBS.</b></p>  <p><b>FITS THREADED FILLER NECK</b></p>	<p><b>10257 18 LBS.</b></p>  <p><b>FITS THREADED FILLER NECK</b></p>









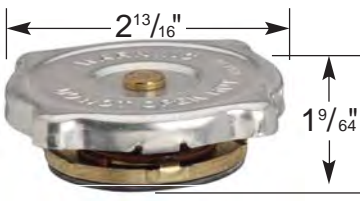

# RADIATOR CAP NUMERICAL LISTING (Continued)

Use as a guide only. Refer to application section for specific vehicle.

<p><b>10258 20 LBS.</b></p>  <p><b>FITS THREADED FILLER NECK</b></p>	<p><b>10264 42 LBS.</b></p>  <p><b>FITS THREADED FILLER NECK</b></p>	<p><b>10271 20 LBS.</b></p>  <p><b>FITS THREADED FILLER NECK</b></p>
<p><b>10259 20 LBS.</b></p>  <p><b>FITS THREADED FILLER NECK</b></p>	<p><b>10265 18.5 LBS.</b></p>  <p><b>FOR RADIATOR OVERFLOW RESERVOIR SYSTEMS FITS 32 MM I.D., 16 MM DEEP NECK</b></p>	<p><b>10281 4 LBS. NO RECOVERY</b></p>  <p><b>FOR "B" SIZE 2 11/16" O.D. 3/4" DEEP FILLER NECK</b></p>
<p><b>10260 15 LBS.</b></p>  <p><b>FITS THREADED FILLER NECK</b></p>	<p><b>10267 20 LBS.</b></p>  <p><b>FOR RADIATOR OVERFLOW RESERVOIR SYSTEMS FITS 32 MM I.D., 16 MM DEEP NECK</b></p>	<p><b>10282 7 LBS. NO RECOVERY</b></p>  <p><b>FOR "B" SIZE 2 11/16" O.D. 3/4" DEEP FILLER NECK</b></p>
<p><b>10261 20 LBS.</b></p>  <p><b>FITS THREADED FILLER NECK</b></p>	<p><b>10268 5 LBS.</b></p>  <p><b>FOR RADIATOR OVERFLOW RESERVOIR SYSTEMS FITS 32 MM I.D., 16 MM DEEP NECK</b></p>	<p><b>10283 10 LBS. NO RECOVERY</b></p>  <p><b>FOR "B" SIZE 2 11/16" O.D. 3/4" DEEP FILLER NECK</b></p>
<p><b>10262 21 LBS.</b></p>  <p><b>FITS THREADED FILLER NECK</b></p>	<p><b>10269 18 LBS.</b></p>  <p><b>FITS THREADED FILLER NECK</b></p>	<p><b>10292 7 LBS.</b></p>  <p><b>FOR "B" SIZE 2 11/16" O.D. 3/4" DEEP FILLER NECK</b></p>
<p><b>10263 15 LBS.</b></p>  <p><b>FITS THREADED FILLER NECK</b></p>	<p><b>10270 10 LBS.</b></p>  <p><b>FITS THREADED FILLER NECK</b></p>	<p><b>10293 10 LBS.</b></p>  <p><b>FOR "B" SIZE 2 11/16" O.D. 3/4" DEEP FILLER NECK</b></p>

# RADIATOR CAP NUMERICAL LISTING (Continued)

Use as a guide only. Refer to application section for specific vehicle.

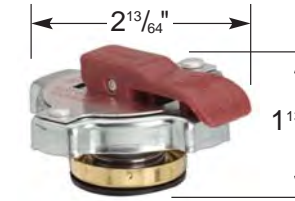
<p><b>10294 15 LBS.</b></p>  <p>FOR "B" SIZE 2 11/16" O.D. 3/4" DEEP FILLER NECK</p>	<p><b>10329 13 LBS.</b></p>  <p>FOR RADIATOR OVERFLOW RESERVOIR SYSTEMS FITS 3/4" DEEP NECK</p>	<p><b>10334 18 LBS.</b></p>  <p>FOR RADIATOR OVERFLOW RESERVOIR SYSTEMS FITS 3/4" DEEP NECK</p>
<p><b>10308 4 LBS.</b></p>  <p>FITS 3/4" DEEP NECK</p>	<p><b>10330 16 LBS.</b></p>  <p>FOR RADIATOR OVERFLOW RESERVOIR SYSTEMS FITS 3/4" DEEP NECK</p>	<p><b>10335 20 LBS.</b></p>  <p>FOR RADIATOR OVERFLOW RESERVOIR SYSTEMS FITS 3/4" DEEP NECK</p>
<p><b>10327 13 LBS.</b></p>  <p>FOR RADIATOR OVERFLOW RESERVOIR SYSTEMS FITS 32 MM I.D., 16 MM DEEP NECK</p>	<p><b>10331 16 LBS. VENTED</b></p>  <p>FOR RADIATOR OVERFLOW RESERVOIR SYSTEMS FITS 3/4" DEEP NECK</p>	<p><b>10337 10 LBS.</b></p>  <p>FOR RADIATOR OVERFLOW RESERVOIR SYSTEMS FITS 3/4" DEEP NECK</p>
<p><b>10328 7 LBS.</b></p>  <p>FOR RADIATOR OVERFLOW RESERVOIR SYSTEMS FITS 3/4" DEEP NECK</p>	<p><b>10333 16 LBS.</b></p>  <p>FOR RADIATOR OVERFLOW RESERVOIR SYSTEMS FITS 32 MM I.D., 16 MM DEEP NECK</p>	

# COOLING SYSTEM ADAPTER CHART FOR RADIATOR CAPS









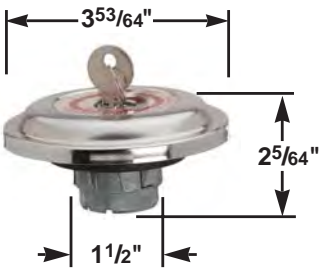

Radiator			Radiator		
Cap	Cap		Cap	Cap	
Number	Adapter	System Adapter	Number	Adapter	System Adapter
10208	12552	System Adapter on Tester	10261	None	12023
10225	12017	12016	10264	12021	12027
10226	12552	System Adapter on Tester	10269	12033	12032
10227	12021	12027	10270	12029	12026
10228	12552	System Adapter on Tester	10271	12033	12032
10229	12552	System Adapter on Tester	10281	12450	12450
10230	12552	System Adapter on Tester	10282	12450	12450
10231	12552	System Adapter on Tester	10283	12450	12450
10233	12021	12027	10292	12450	12450
10234	12552	System Adapter on Tester	10265	12021	12027
10235	12552	System Adapter on Tester	10267	12021	12027
10237	12552	System Adapter on Tester	10268	12021	12027
10238	12029	12026	10293	12450	12450
10239	12029	12026	10294	12450	12450
10240	12029	12026	10327	12021	12027
10241	12024	12025	10328	12552	System Adapter on Tester
10242	12024	12025	10329	12552	System Adapter on Tester
10243	None	12028	10330	12552	System Adapter on Tester
10244	None	12018	10331	12552	System Adapter on Tester
10245	None	12018	10333	12021	12027
10246	None	12030	10334	12552	System Adapter on Tester
10247	None	12030	10335	12552	System Adapter on Tester
10248	12033	12032	10337	12552	System Adapter on Tester
10249	12037	12036	10361	12021	12027
10250	12035	12034	10362	12021	12027
10251	12041	12040	10371	12552	System Adapter on Tester
10252	None	12018	10372	12552	System Adapter on Tester
10253	12039	12038	10373	12552	System Adapter on Tester
10255	None	12019	10381	12552	System Adapter on Tester
10257	12029	12026	10382	12552	System Adapter on Tester
10258	12029	12026	10391	12552	System Adapter on Tester
10259	12035	12034	10392	12552	System Adapter on Tester
10260	None	12018	10393	12552	System Adapter on Tester

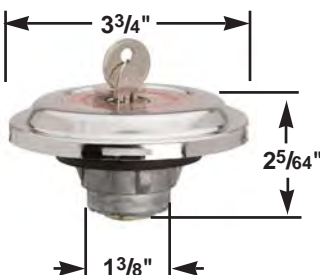
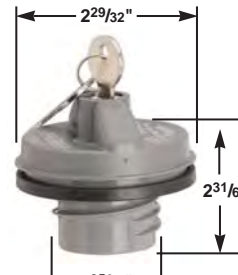
Radiator Cap Pressure Ratings	
4#	3 - 5
7#	6 - 8
10#	9 - 11
13#	12 - 16
14#	12 - 16
15#	14 - 18
16#	14 - 18
18#	16 - 20
20#	18 - 22

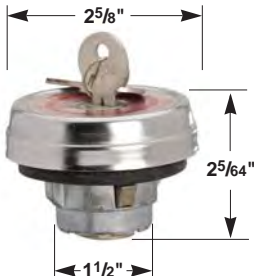

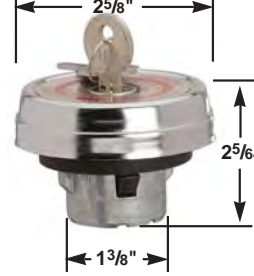
# LOCKING FUEL CAP NUMERICAL LISTING

Use as a guide only. Refer to application section for specific vehicle.

<p><b>10411</b></p>  <p>LOCKING NOT VENTED 2 1/8" x 12 Male Thread</p>	<p><b>10483</b></p>  <p>LOCKING TYPE VENTED, ANTI SURGE TYPE</p>	<p><b>10502, 10502D, 10502Y</b></p>  <p>LOCKING EMISSION CONTROL TYPE</p>
<p><b>10412</b></p>  <p>LOCKING NOT VENTED 2 1/2" x 8 Female Thread</p>	<p><b>10484</b></p>  <p>LOCKING TYPE VENTED, ANTI SURGE TYPE</p>	<p><b>10503</b></p>  <p>LOCKING EMISSION CONTROL TYPE</p>
<p><b>10413</b></p>  <p>LOCKING VENTED 2" x 11 1/2 Female Thread</p>	<p><b>10491</b></p>  <p>LOCKING TYPE VENTED, ANTI SURGE TYPE</p>	<p><b>10504, 10504Y</b></p>  <p>LOW LEAK LOCKING EMISSION CONTROL TYPE</p>
<p><b>10419</b></p>  <p>LOCKING NOT VENTED 4" x 8 Female Thread</p>	<p><b>10492</b></p>  <p>LOCKING TYPE VENTED, ANTI SURGE TYPE</p>	<p><b>10505</b></p>  <p>LOCKING VACUUM-ONLY</p>
<p><b>10420</b></p>  <p>LOCKING NOT VENTED 4 1/4" x 8 M ale Thread</p>	<p><b>10501, 10501D</b></p>  <p>PRE-VENT® LOCKING FUEL CAP EMISSION CONTROL TYPE</p>	<p><b>10506</b></p>  <p>LOCKING EMISSION CONTROL TYPE</p>

# LOCKING FUEL CAP NUMERICAL LISTING (Continued)

Use as a guide only. Refer to application section for specific vehicle.

<p><b>10507</b></p>  <p><b>LOCKING EMISSION CONTROL TYPE</b></p>	<p><b>10512</b></p>  <p><b>LOCKING EMISSION CONTROL TYPE</b></p>	<p><b>10522</b></p>  <p><b>LOCKING EMISSION CONTROL TYPE</b></p>
<p><b>10508, 10508D, 10508Y</b></p>  <p><b>LOCKING EMISSION CONTROL TYPE</b></p>	<p><b>10516</b></p>  <p><b>NON VENTED</b></p>	<p><b>10523</b></p>  <p><b>LOCKING EMISSION CONTROL TYPE</b></p>
<p><b>10509</b></p>  <p><b>LOCKING EMISSION CONTROL TYPE</b></p>	<p><b>10517</b></p>  <p><b>LOCKING EMISSION CONTROL TYPE</b></p>	<p><b>10524</b></p>  <p><b>LOCKING COVER</b></p>
<p><b>10510, 10510D, 10510Y</b></p>  <p><b>LOCKING EMISSION CONTROL TYPE</b></p>	<p><b>10518</b></p>  <p><b>LOCKING EMISSION CONTROL TYPE</b></p>	<p><b>10559</b></p>  <p><b>LOCKING EMISSION CONTROL TYPE</b></p>
<p><b>10511, 10511Y</b></p>  <p><b>LOCKING EMISSION CONTROL TYPE</b></p>	<p><b>10521</b></p>  <p><b>LOCKING EMISSION CONTROL TYPE</b></p>	<p><b>10563</b></p>  <p><b>LOCKING NON-VENTED</b></p>

# LOCKING FUEL CAP NUMERICAL LISTING (Continued)

Use as a guide only. Refer to application section for specific vehicle.

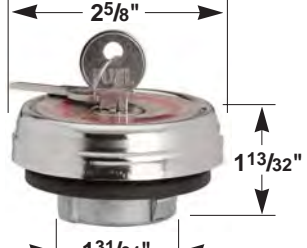
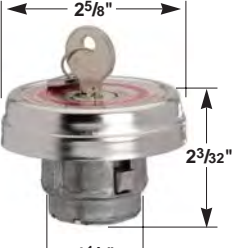
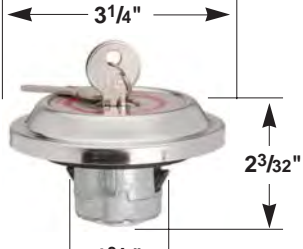
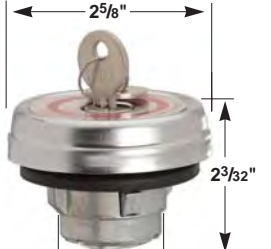
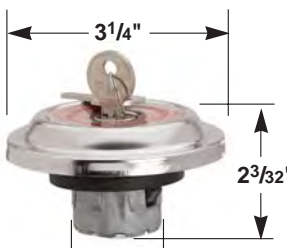
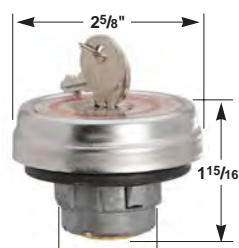
<p><b>10565</b></p>  <p>LOCKING EMISSION CONTROL TYPE DEEP CAM TYPE</p>	<p><b>10579</b></p>  <p>LOCKING NON-VENTED TYPE</p>	<p><b>10587</b></p>  <p>LOCKING EMISSION CONTROL TYPE</p>
<p><b>10571</b></p>  <p>LOCKING EMISSION CONTROL TYPE DEEP CAM TYPE</p>	<p><b>10580</b></p>  <p>LOCKING EMISSION CONTROL TYPE DEEP CAM TYPE</p>	<p><b>10589</b></p>  <p>LOCKING EMISSION CONTROL TYPE</p>
<p><b>10572</b></p>  <p>LOCKING EMISSION CONTROL TYPE DEEP CAM TYPE</p>	<p><b>10582</b></p>  <p>LOCKING EMISSION CONTROL TYPE</p>	<p><b>10591</b></p>  <p>LOCKING EMISSION CONTROL TYPE</p>
<p><b>10573</b></p>  <p>LOCKING EMISSION CONTROL TYPE DEEP CAM TYPE</p>	<p><b>10583</b></p>  <p>LOCKING EMISSION CONTROL TYPE</p>	<p><b>10592</b></p>  <p>LOCKING EMISSION CONTROL TYPE</p>
<p><b>10574</b></p>  <p>LOCKING VENTED, ANTI SURGE TYPE DEEP CAM TYPE</p>	<p><b>10584</b></p>  <p>LOCKING NON-VENTED</p>	<p><b>10593</b></p>  <p>LOCKING EMISSION CONTROL TYPE</p>

# LOCKING FUEL CAP NUMERICAL LISTING (Continued)

Use as a guide only. Refer to application section for specific vehicle.

<p><b>10594</b></p>  <p><b>LOCKING NON-VENTED</b></p>	<p><b>10596</b></p>  <p><b>LOCKING NON-VENTED</b></p>	<p><b>10598</b></p>  <p><b>LOCKING TYPE VENTED, ANTI SURGE TYPE</b></p>
<p><b>10595</b></p>  <p><b>LOCKING VACUUM ONLY</b></p>	<p><b>10597</b></p>  <p><b>LOCKING PRESSURE RELIEF</b></p>	





# FUEL CAP NUMERICAL LISTING

Use as a guide only. Refer to application section for specific vehicle.

<p><b>10601</b></p> <p>2 1/16" 2 1/4" NON-VENTED 2 1/8" X 12 MALE THREAD</p>	<p><b>10609</b></p> <p>4 25/32" 8 1/32" NON-VENTED 4" X 8 FEMALE THREAD</p>	<p><b>10640</b></p> <p>2 17/32" 1 3/8" 1 1/2" VENTED, ANTI-SURGE TYPE</p>
<p><b>10602</b></p> <p>2 13/16" 2 1/4" NON-VENTED 2 1/2" X 8 FEMALE THREAD</p>	<p><b>10610</b></p> <p>4 31/32" 8" NON-VENTED 4 1/4" X 8 FEMALE THREAD</p>	<p><b>10646</b></p> <p>2 3/16" 1 1/4" 1 3/8" VENTED, ANTI-SURGE TYPE</p>
<p><b>10603</b></p> <p>2 49/64" 3 3/64" VENTED 2" X 11 1/2" FEMALE THREAD</p>	<p><b>10623</b></p> <p>2 7/8" 1 1/8" 1 1/2" VENTED, ANTI-SURGE TYPE</p>	<p><b>10648</b></p> <p>2 7/8" 1 3/32" 1 3/8" VENTED I.C.C. TYPE</p>
<p><b>10604</b></p> <p>4 7/16" 29/32" VENTED FITS 3 CAM 3 3/8" I.D. ORDNANCE NECK</p>	<p><b>10624</b></p> <p>3 3/4" 1 13/32" 1 1/2" VENTED, ANTI-SURGE TYPE</p>	<p><b>10649</b></p> <p>3 1/16" 1 33/64" 1 3/8" VENTED, ANTI-SURGE TYPE</p>
<p><b>10605</b></p> <p>5 3/32" 8 1/4" NON-VENTED 4 1/4" X 12 MALE THREAD</p>	<p><b>10625</b></p> <p>2 7/8" 7/8" 1 7/8" VENTED</p>	<p><b>10702</b></p> <p>2 7/8" 1 13/64" 1 1/2" PRESSURE VACUUM TYPE EMISSION CONTROL DEEP CAM TYPE</p>
<p><b>10608</b></p> <p>4 9/64" 8" VENTED 3 1/2" X 5 1/2" FEMALE THREAD</p>	<p><b>10632</b></p> <p>2 13/32" 1 11/32" 1 3/8" NON-VENTED, DEEP CAM TYPE</p>	<p><b>10704</b></p> <p>2 7/8" 1 13/64" 1 1/2" PRESSURE VACUUM TYPE FOR EMISSION CONTROL</p>

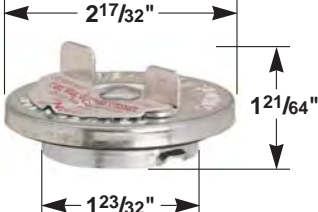
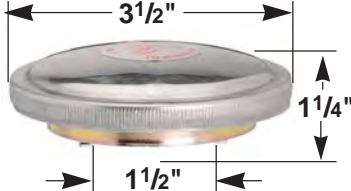
# FUEL CAP NUMERICAL LISTING (Continued)

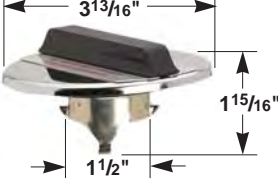
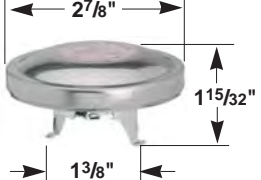
Use as a guide only. Refer to application section for specific vehicle.

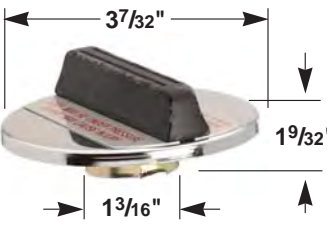
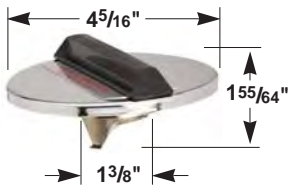
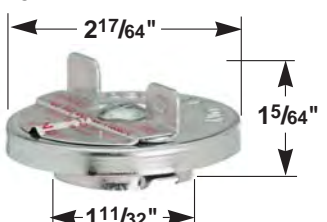
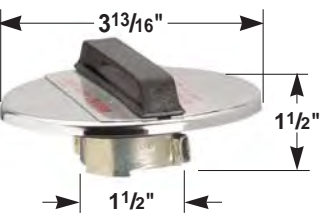
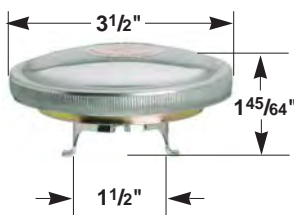
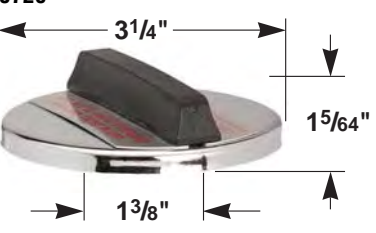
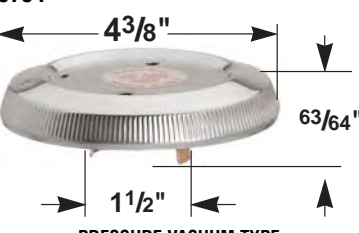
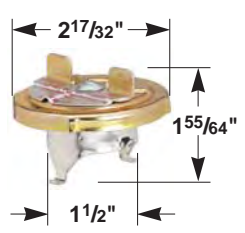
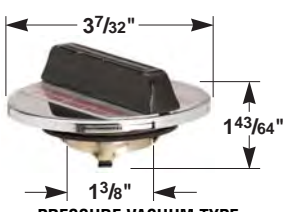
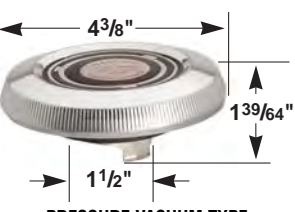
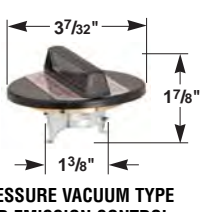
<p><b>10705</b></p>  <p>PRESSURE VACUUM TYPE FOR EMISSION CONTROL</p>	<p><b>10730</b></p>  <p>VACUUM ONLY</p>	<p><b>10741</b></p>  <p>PRESSURE VACUUM TYPE FOR EMISSION CONTROL</p>
<p><b>10713</b></p>  <p>PRESSURE VACUUM TYPE FOR EMISSION CONTROL DEEP CAM TYPE</p>	<p><b>10731</b></p>  <p>PRESSURE VACUUM TYPE FOR EMISSION CONTROL DEEP CAM TYPE</p>	<p><b>10742</b></p>  <p>PRESSURE VACUUM TYPE FOR EMISSION CONTROL DEEP CAM TYPE</p>
<p><b>10724</b></p>  <p>NON-VENTED</p>	<p><b>10732</b></p>  <p>NON-VENTED</p>	<p><b>10746</b></p>  <p>PRESSURE VACUUM TYPE FOR EMISSION CONTROL DEEP CAM TYPE</p>
<p><b>10725</b></p>  <p>NON-VENTED</p>	<p><b>10733</b></p>  <p>PRESSURE VACUUM TYPE FOR EMISSION CONTROL</p>	<p><b>10748</b></p>  <p>VENTED, ANTI-SURGE TYPE DEEP CAM TYPE</p>
<p><b>10726</b></p>  <p>NON-VENTED</p>	<p><b>10734</b></p>  <p>PRESSURE VACUUM TYPE FOR EMISSION CONTROL</p>	<p><b>10749</b></p>  <p>VENTED, ANTI-SURGE TYPE DEEP CAM TYPE</p>
<p><b>10727</b></p>  <p>PRESSURE VACUUM TYPE FOR EMISSION CONTROL</p>	<p><b>10735</b></p>  <p>PRESSURE VACUUM TYPE FOR EMISSION CONTROL</p>	<p><b>10800</b></p>  <p>PRESSURE VACUUM TYPE FOR EMISSION CONTROL DEEP CAM TYPE</p>













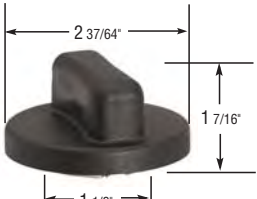



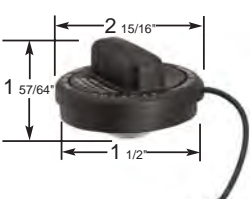

# FUEL CAP NUMERICAL LISTING (Continued)

Use as a guide only. Refer to application section for specific vehicle.

<p><b>10806</b></p>  <p><b>PRESSURE VACUUM TYPE FOR EMISSION CONTROL</b></p>	<p><b>10817</b></p>  <p><b>PRESSURE VACUUM TYPE FOR EMISSION CONTROL</b></p>	<p><b>10824</b></p>  <p><b>NON-VENTED</b></p>
<p><b>10807</b></p>  <p><b>PRESSURE VACUUM TYPE FOR EMISSION CONTROL DEEP CAM TYPE</b></p>	<p><b>10818</b></p>  <p><b>PRESSURE VACUUM TYPE FOR EMISSION CONTROL</b></p>	<p><b>10825</b></p>  <p><b>VACUUM ONLY</b></p>
<p><b>10810</b></p>  <p><b>PRESSURE VACUUM TYPE FOR EMISSION CONTROL</b></p>	<p><b>10819, 10819D</b></p>  <p><b>PRE-VENT® PRESSURE VACUUM TYPE FOR EMISSION CONTROL</b></p>	<p><b>10826</b></p>  <p><b>NON-VENTED</b></p>
<p><b>10811</b></p>  <p><b>PRESSURE VACUUM TYPE FOR EMISSION CONTROL</b></p>	<p><b>10821</b></p>  <p><b>PRE-VENT® PRESSURE VACUUM TYPE FOR EMISSION CONTROL</b></p>	<p><b>10827</b></p>  <p><b>PRESSURE RELIEF</b></p>
<p><b>10815</b></p>  <p><b>PRESSURE VACUUM TYPE FOR EMISSION CONTROL</b></p>	<p><b>10822</b></p>  <p><b>NON-VENTED</b></p>	<p><b>10828</b></p>  <p><b>VENTED, ANTI-SURGE TYPE</b></p>
<p><b>10816</b></p>  <p><b>NON-VENTED</b></p>	<p><b>10823</b></p>  <p><b>PRE-VENT® VACUUM ONLY</b></p>	<p><b>10829</b></p>  <p><b>PRESSURE VACUUM TYPE FOR EMISSION CONTROL</b></p>

# FUEL CAP NUMERICAL LISTING (Continued)

Use as a guide only. Refer to application section for specific vehicle.

<p><b>10830, 10830D</b></p>  <p><b>PRESSURE VACUUM TYPE FOR EMISSION CONTROL</b></p>	<p><b>10837</b></p>  <p><b>PRESSURE VACUUM TYPE FOR EMISSION CONTROL</b></p>	<p><b>10843</b></p>  <p><b>NON-VENTED</b></p>
<p><b>10832, 10832D, 10832Y</b></p>  <p><b>PRESSURE VACUUM TYPE FOR EMISSION CONTROL</b></p>	<p><b>10838, 10838D, 10838Y</b></p>  <p><b>PRESSURE VACUUM TYPE FOR EMISSION CONTROL</b></p>	<p><b>10844</b></p>  <p><b>NON-VENTED</b></p>
<p><b>10833</b></p>  <p><b>PRESSURE VACUUM TYPE FOR EMISSION CONTROL</b></p>	<p><b>10839</b></p>  <p><b>PRESSURE VACUUM TYPE FOR EMISSION CONTROL</b></p>	<p><b>10845</b></p>  <p><b>NON-VENTED</b></p>
<p><b>10834, 10834Y</b></p>  <p><b>PRESSURE VACUUM TYPE FOR EMISSION CONTROL</b></p>	<p><b>10840, 10840D, 10840Y</b></p>  <p><b>VACUUM ONLY</b></p>	<p><b>10846</b></p>  <p><b>NON-VENTED</b></p>
<p><b>10835</b></p>  <p><b>VACUUM ONLY</b></p>	<p><b>10841, 10841Y</b></p>  <p><b>VACUUM ONLY</b></p>	<p><b>10847</b></p>  <p><b>PRESSURE VACUUM TYPE FOR EMISSION CONTROL</b></p>
<p><b>10836</b></p>  <p><b>PRESSURE VACUUM TYPE FOR EMISSION CONTROL</b></p>	<p><b>10842</b></p>  <p><b>PRESSURE VACUUM TYPE FOR EMISSION CONTROL</b></p>	<p><b>10848</b></p>  <p><b>PRESSURE VACUUM TYPE FOR EMISSION CONTROL</b></p>



# FUEL CAP NUMERICAL LISTING (Continued)

Use as a guide only. Refer to application section for specific vehicle.

<p><b>10851</b></p>  <p><b>PRESSURE VACUUM TYPE FOR EMISSION CONTROL</b></p>	<p><b>41001</b></p>  <p><b>INSTANT FILL™ FUEL CAP</b></p>	<p><b>41004</b></p>  <p><b>INSTANT FILL™ FUEL CAP</b></p>
<p><b>10852</b></p>  <p><b>NON VENTED</b></p>	<p><b>41002</b></p>  <p><b>INSTANT FILL™ FUEL CAP</b></p>	
<p><b>10853</b></p>  <p><b>VENTED, ANTI-SURGE TYPE</b></p>	<p><b>41003</b></p>  <p><b>INSTANT FILL™ FUEL CAP</b></p>	

## TESTERS AND ADAPTERS

The 12270 30 pound cooling system and pressure cap tester, tests up to 30 pound cooling systems and pressure caps.

The Stant® 12270 tester lets you test today's cars higher pressure cooling systems and pressure caps up to 30 pounds.

The 12270 gauge includes additional cap testing pressure ranges of 17-19 lbs., 20 lbs., and 28-30 lbs. The large color coded dial makes it easy to accurately test these higher pressure caps and systems.

The 12270 head also includes a pressure release bar that when turned clockwise, releases pressure buildup before removing the head from the neck.

Although the 12270 tester replaces our 12255, all Stant® pressure cap and cooling system adapters can be used on either tester. We've even created a conversion kit, 12701, that allows you to convert your 12255 to a 12270.

The 12270 pressure tester comes in it's own plastic carrying case with one 12559 spacer to drop in 1" deep filler necks for testing, one 12552 cap adapter to check Standard "A" Size caps, and a complete easy to use instruction manual including cooling system and pressure cap testing instructions as well as usage instructions and applications for all Stant® adapters.



PRESSURE RELEASE BAR



**12701 Conversion kit. Allows you to update your 12255 tester to the 30 pound 12270.**

The 12701 kit includes a 30 pound gauge, hose and head assembly including the pressure release bar and 30 pound spring, and the 12270 instruction manual.



### Tester Adapter Carrying Case

12001 is a convenient way to store and carry your tester adapters. The 12001 tester adapter carrying case is constructed of durable plastic. A molded corner pocket is also included for small parts and gaskets. Keep all your Stant® tester adapters clean, dry, handy and organized.

# STANT® 12270 TESTER ADAPTERS

Refer to cap applications for specific vehicle.



**12015 threaded adapter** is required to fit some White and GMC trucks with threaded filler necks. 2 1/2" threaded diameter.



12016



12017

**12016 threaded cooling system adapter and 12017 threaded cap adapter** is required to fit late model Audi, Porsche and Volkswagen with threaded filler necks as well as Mack Pinacle and Volvo VN Series trucks. (Vehicles using the Stant® 10225 radiator cap). Thread specifications M 48 x 3.



**12018 threaded adapter** is required to fit some Volvo, Saab and late model Renault cooling systems with a threaded filler neck on the expansion tank. Thread specifications M 43.2 x 3. (Vehicles using the Stant® 10244, 10245, 10252, and 10260 radiator cap).



**12019 threaded adapter** is required to fit early 80's BMW cooling systems with a threaded filler neck on the expansion tank. Threaded specifications M 52 x 4. (Vehicles using the Stant® 10255 radiator cap).



12021



12027

**12021 cap adapter and 12027 system testing adapter.** These are required to test the "mini" diameter (32mm I.D. 16mm deep) cooling system filler necks and radiator cap applications (vehicles using the Stant® 10227, 10233, 10264, 10265, 10267, 10268, 10327, and 10333 radiator caps).



**12023 threaded adapter** is required to test all threaded cooling system filler necks on late model Jaguar and Pontiac LeMans cars. (Vehicles using the Stant® 10261 radiator cap). Threaded specifications M 52 x 3.



12024



12025

**12024 cap adapter and 12025 cooling system adapters** are required to test the "micro" diameter (31mm I.D. 10mm deep) radiator caps and cooling systems as used on many late model Acura, Honda, Lexus, Mitsubishi, Suzuki, and Toyota's. (Vehicles using the Stant® 10241 and 10242 radiator caps).



12026



12029

**12026 cooling system adapter and 12029 threaded cap adapter** is required to test cooling systems on late model GM "N" body cars, Saturn and full size Ford cars and Super Duty's as well as some Navistar, Kenworth, and Sterling's. Thread specifications M 52 x 2.5 Buttress. (Vehicles using the Stant® 10238, 10239, 10240, 10257, 10258, and 10270 radiator caps).



**12028 system testing adapter** is required to test 1990 and newer Volkswagen cooling systems with a threaded filler neck. (Vehicles using Stant® 10243 radiator cap). Thread specifications M 57 x 3.



**12030 threaded system testing adapter** is required to test most BMW and Land Rover cooling systems with a threaded filler neck. (Vehicles using Stant® 10246, 10247 radiator caps).

# STANT® 12270 TESTER ADAPTERS

Refer to adapter applications for specific vehicle.



12032  
48mm ID



12033

**12032 threaded system adapter and 12033 radiator cap adapter** are required to test cooling systems and caps on many late model GM cars and trucks, also Freightliner and IHC trucks. (Vehicles using the Stant® 10248, 10269, and 10271 radiator cap).



12034  
49.25 mm ID



12035

**12034 threaded system adapter and 12035 threaded cap adapter** are required to test many cooling system filler necks and caps on Chevrolet, Ford, Mercury, Saab, and Saturn. (Vehicles using the Stant® 10250, 10259, and 10261 radiator cap).



12036



12037  
59 mm ID

**12036 threaded system adapter and 12037 threaded cap adapter** are required to test cooling system filler necks and caps on many late model Audi, Porsche and Volkswagen cars. (Vehicles using the Stant® 10249 pressure cap).



12038  
59.5 mm ID



12039

**12038 threaded cooling system adapter and 12039 threaded cap adapter** are required to test many threaded cooling system filler necks and caps on late model Mercedes. (Vehicles using the Stant® 10253 pressure cap).



12040  
48 mm



12041

**12040 threaded cooling system adapter and 12041 threaded cap adapter** are required to test all threaded cooling system filler necks and caps on many late model Ford, Mazda, and Mercury's. (Vehicles using the Stant® 10251 pressure cap).



**12042 threaded cooling system adapter** testing adapter for use on many Volvo medium and heavy duty trucks. Thread specifications 64 x 3.



**12450 truck adapter kit** includes two solid die cast, chrome plated cap and radiator adapters, one  $\frac{7}{8}$ " plug (12451) and one large rubber gasket (12452). Fits all popular trucks with the large diameter ( $2\frac{1}{16}$ " O.D. "B" size) filler neck. (Tests same applications as Stant®: 10281, 10282, 10283, 10292, 10293, and 10294 radiator caps).



**12451 rubber plug** for truck cooling systems is  $\frac{7}{8}$ " thick and can be ordered for replacement separately from the 12450 truck adapter kit.



**12452 rubber gasket** for use with the 12453 GM adapter kit when checking late model GM X-cars with the 1.8L and 2.0L engines. The 12452 is available for replacement or for those already owning a 12450 truck adapter kit.



**12453 kit** includes a 12452 rubber gasket and the "B" size filler neck adapter from the 12450 truck adapter kit. This is the complete separate kit for testing GM X-cars with the 2.5L engine and J-cars with the 1.8L and 2.0L engine.

# STANT® 12270 Assortments

Use as a guide only.



**12552 cap adapter** for use with 12270 tester to check 3/4" deep caps. (Both ends of adapter are 3/4" deep.) (Vehicles using the Stant® 10208, 10226, 10228, 10229, 10230, 10231, 10234, 10235, 10237, 10308, 10328, 10329, 10330, 10331, 10334, 10335, 10337 radiator caps). No adapter is required to test the cooling systems on these vehicles.



## 12031

### Adapter Gasket Replacement Pack

Pack consists of replacement gaskets for 12 popular adapters. Renews the sealing integrity of these adapters at a fraction of the cost of an adapter replacement. All gaskets in the pack are individually bagged and identified by adapter part number. Pack consist of: 12015, 12017, 12018, 12019, 12023, 12025, 12026, 12027, 12030, 12270, 12450, and 12453.

---

## ADAPTER ASSORTMENTS

**10022** - Popular cap and system set includes:

12021, 12026, 12027, 12029, 12032, 12033

**10042** - Ford/Mercury includes:

12021, 12026, 12027, 12029, 12034, 12035, 12041, 12042

**10043** - GM includes:

12021, 12023, 12024, 12025, 12026, 12027, 12029, 12032, 12033

**10044** -Chrysler/Dodge ; Honda/Acura; Toyota/Lexus includes:

12021, 12024, 12025, 12027

**10045** -Nissan Infiniti includes:

12021, 12026, 12027, 12029

**10046** -VW, Porsche, Audi includes:

12016, 12017, 12028, 12036, 12037

**10047** - Heavy Duty Truck assortment includes:

12015, 12026, 12029, 12032, 12033, 12042, 12450

**12004** - Tester adapter assortment includes:

12025, 12026, 12027, 12032, 12034, 12001 Case

**Use Genuine Stant® Repair Parts  
To Keep Your Stant® Cooling System Tester Working For You.**

**12270 Pressure Tester  
Repair Parts.**

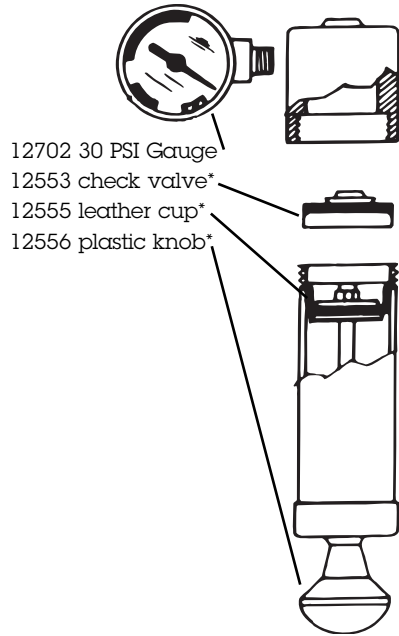

**12704 Hose and head kit.** For use with 12255 or 12270 tester. Includes 12559 spacer washer for 1" deep filler necks. Replaces 12557



**12703 head repair kit.** Includes 12559 spacer. Use this kit with the 12270 30 pound tester.



**12559 spacer** drop in 1" deep filler necks for testing.

\*For use with 12270 tester as well.

## Fuel Cap Tester

---

The Stant Fuel Cap Tester makes it quick and easy to accurately test fuel caps for leaks. This product has been developed to test fuel caps for compliance with current EPA regulations. Using this tool will help speed the test procedure, enabling you to accurately test more cars per day. The use of this tool is very important in emission tune-up facilities.

The Stant Fuel Cap Tester uses the flow comparison method of testing. That is, the leak rate of the cap being tested is compared to a pre-determined leak rate in the tester.



### **12370 Mechanical Fuel Cap Tester Kit**

The 12370 mechanical fuel cap tester can be used by automotive repair outlets to pre-qualify consumers' fuel caps prior to their trip to the state test lanes. The 12370 allows auto parts stores and repair facilities an economical alternative to the electronic testers. The 12370 kit includes the tester unit including the standard threaded adapter packed inside its own plastic carrying case, two tester calibration caps to check the tester's accuracy, and twelve fuel cap adapters for various neck configurations in their own plastic carrying case.

# Fuel Cap Tester



- 12301 Mechanical Tester Unit  
Mechanical Tester Unit Including 12410 Threaded Adapter Packed in it's own molded plastic carrying case. Includes JB-1215 user's manual.



- 12302 Mechanical Tester Replacement Gauge

- 12470 Complete Mechanical Tester System



- 12301 Electronic Tester Unit Including 12410 Threaded Adapter  
12402 Molded Plastic Adapter Carrying Case  
12403 Blue Adapter  
12404 Yellow Adapter  
12405 Red Adapter  
12406 Green Adapter  
12407 Black Adapter  
12408 Gray Adapter  
12411 Green "Pass" Calibration Cap  
12412 Red "Fail" Calibration Cap  
12419 Orange Adapter  
12421 Light Blue Adapter  
12422 Tan Adapter  
12423 Light Green Adapter  
12424 Cream Adapter  
12426 Pink Adapter  
JB-1203 Tester User's Manual



- 12403 Blue  $1\frac{3}{8}$ " Shallow Cam Cap Adapter w/black ring  
For use on caps fitting  $1\frac{3}{8}$ " shallow cam filler necks including most 70's model AMC, Chrysler, and Toyota cars and trucks.



- 12404 Yellow  $1\frac{3}{8}$ " Deep Cam Cap Adapter w/black ring  
For use on caps fitting  $1\frac{3}{8}$ " deep cam filler necks including many early 70's GM full size cars and mid 70's Chrysler cars.



- 12405 Red  $1\frac{1}{2}$ " Shallow Cam Cap Adapter w/white ring  
For use on caps fitting  $1\frac{1}{2}$ " shallow cam filler necks including late model Audi, BMW, Mercedes, and 70's model Ford, Lincoln, and Mercury cars.



- 12406 Green  $1\frac{1}{2}$ " Deep Cam Cap Adapter w/black ring  
For use on caps fitting  $1\frac{1}{2}$ " deep cam filler necks including 70's model Ford and IHC pickup trucks.



- 12407 Black  $1\frac{1}{2}$ " Shallow Cam Honda Adapter w/white ring  
For use on Honda and Acura caps fitting  $1\frac{1}{2}$ " shallow cam filler necks.



- 12408 Gray  $1\frac{3}{8}$ " Shallow Cam Nissan Adapter w/black ring  
For use on Nissan caps fitting  $1\frac{3}{8}$ " shallow cam filler necks.



- 12410 Threaded Adapter  
This adapter is required to test threaded fuel caps used on most cars and trucks since the mid 80's. All other Stant cap adapters are used with the threaded adapter. Comes attached to mechanical and electronic tester units.



# Fuel Cap Tester



12411 Green "Pass" Calibration Cap  
Use this cap to periodically test the system. If this cap passes, the system is working properly.



12412 Red "Fail" Calibration Cap  
Use this cap to periodically test the system. If this cap fails, the system is working properly.



12414 Button Repair Kit  
Includes replacement button and allen wrench for installation.



12417 Pump Oil  
1/2 ounce of neatsfoot oil for periodic oiling of the pump barrel.



12418 Adapter Seal  
Replacement rubber sealing gasket for adapters.



12419 Orange 1/8th Turn Cap Adapter w/grey ring  
For use on caps fitting 1996-2006 Fords, Lincolns and Mercurys.



12421 Light Blue GM "Quick On" Cap Adapter w/black ring  
For use on the new OBDII GM quick-on fuel caps for 1997 -2005.



12422 Tan Chrysler "Quick On" Cap Adapter w/grey ring  
The 12422 adapter is used to test many Chrysler, Ford, General Motors, Hyundai, Infiniti, Isuzu, Jeep, Kia, Lexus, Mercedes-Benz, Nissan, Saab, Suzuki, and Toyota's.



12423 Light Green Threaded Cap Adapter w/black ring  
The 12423 is designed for the quick-on style threaded fuel caps with shortened threads used on many late model Acura, Audi, Honda, Porsche, Volkswagen and Volvo cars.



12424 Cream Cap Adapter w/black ring  
The 12424 is for late model Jaguar, Land Rover, Mazda and Volvo quick-on fuel caps.



12426 Pink Cap Adapter w/black ring  
The 12426 is for late model BMW and Mercedes quick-on fuel caps.

# Fuel Cap Tester



- 12472 Molded Plastic Tester Carrying Case Only  
Includes spaces for twelve adapters. Also includes spaces for the "pass" and "fail" calibration caps and the threaded adapter.



- 12480 Communicating Electronic Tester System
- 12441 Communicating Electronic Tester Unit With 12410 Threaded Adapter
  - 12402 Molded Plastic Adapter Carrying Case
  - 12403 Blue Adapter
  - 12404 Yellow Adapter
  - 12405 Red Adapter
  - 12406 Green Adapter
  - 12407 Black Adapter
  - 12408 Gray Adapter
  - 12411 Green "Pass" Calibration Cap
  - 12412 Red "Fail" Calibration Cap
  - 12419 Orange Adapter
  - 12421 Light Blue Adapter
  - 12422 Tan Adapter
  - 12423 Light Green Adapter
  - 12424 Cream Adapter
  - JB-1215 Tester Owner's Manual



- 12556 Plastic Knob  
Available as a replacement to the one sold with the tester.



- JB-1215 12470 Mechanical Tester Unit User's Manual  
Features operating instructions, maintenance procedures and troubleshooting tips for 12470 tester.



**NOTE: Alternate temperature thermostats are for off-road and performance vehicles and are NOT intended for an OE direct replacement.**

## Stant® Reverse Poppet Thermostats

The heart of the Stant® reverse poppet thermostat is the ELAC® heat motor. The unique properties of the heat motor result in a consistent and precise response to the cooling system's needs. This is achieved through the use of a precisely formulated, thermally expansive wax fill that is calibrated to operate within OEM requirements. The Stant® heat motor is powered by a precisely formulated thermal responsive wax pellet in a heat conducting copper cup equipped with a stainless steel piston inside an elastomeric boot. The exact length of the stainless steel piston assures the prompt and precise operation of the thermostat valve. Each manufacturing process is rigidly controlled with world class quality controls. Then a 100% calibration is conducted for each heat motor to guarantee quality and performance.

The Stant® thermostat design forms more material at the bridge adding more strength to the top. The flange is made without a step in order to fit newer vehicles. The bottom strap or frame has the same width but is formed for added strength and to firmly hold the spring in place. The completed assembly provides a securely sealed, heat responsive valve that keeps engine temperatures within original equipment specifications.

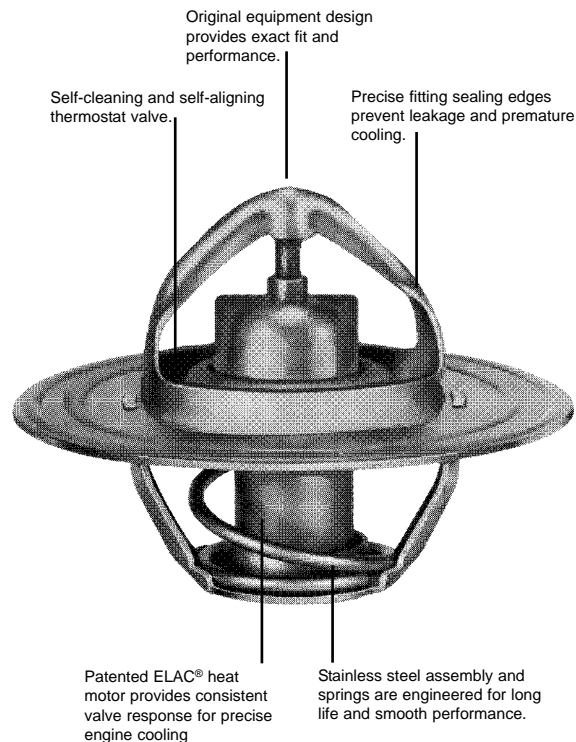

## Installation Instructions

### For Most Reverse Poppet Thermostats

**Caution: Failure to comply with these instructions may result in serious injury.**

1. Allow cooling system to cool before servicing.
2. Prevent accidental starting of the engine by removing the ignition key.
3. Drain and flush cooling system.
4. Remove the outlet housing and take out old thermostat and gasket.
5. Clean gasket mounting surfaces.
6. Install thermostat with copper pellet toward engine (see installation sketch).
7. Install new gasket by aligning bolt holes.
8. Replace outlet housing. Tighten bolts evenly.
9. Refill cooling system and run engine with radiator cap removed to normal operating temperature while checking for leaks.
10. After engine has reached normal operating temperature, shut off engine and allow engine to cool and recheck coolant level. Add coolant if needed. Test radiator pressure cap and replace if needed. Install radiator pressure cap.

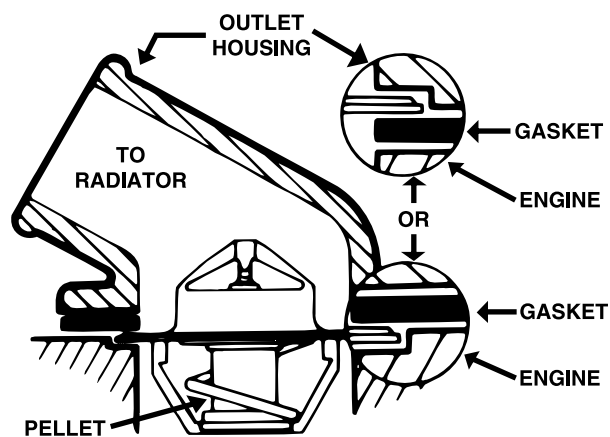

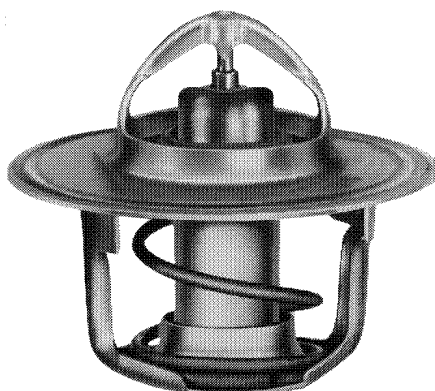

## Stant® SuperStat® Thermostats

Unlike conventional thermostats that continually open and close to achieve the proper operation temperature and flood the engine with coolant, the Stant® SuperStat® thermostat has a patented V-notch, non linear design that reduces cycling by precisely metering the amount of coolant needed.

The V-notches provide a small initial flow. As the engine heats up, the V-notches gradually open wider, metering coolant released into the system until the desired engine temperature is reached.

The benefits of proper engine temperature control are: efficient engine operation, prolonged engine life, reduced oil consumption, improved fuel economy and improved emissions.

---

The Stant® SuperStat® thermostat uses a high flow venturi for maximum cooling capacity during high temperature high load operation, and employs a patented Weir Valve, for precision flow metering during cold weather light load operation, to ensure stable temperature control under all conditions.

The high strength stainless steel flange is burnished to a bright finish for stress relief and added corrosion resistance.

The Stant® SuperStat® thermostat flange thickness of .040" is 33% thicker than our standard reverse poppet thermostat and up to 43% thicker than competitive thermostats for added strength and longer life.

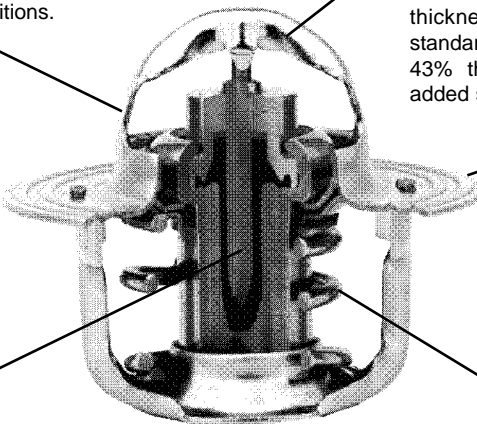

The power element of the Stant® SuperStat® thermostat is comparable to those used in thermostats for the heavy duty trucking industry. It employs an actuator piston that is 25% larger in diameter than our standard reverse poppet thermostat and 56% larger than competitive product. This larger heavy duty piston delivers one and one half times the power of our standard thermostat and almost two and one half times as much power as competitive stats for enhanced durability and longer life.

The operating spring of the Stant® SuperStat® thermostat is designed with a load that is 50% stronger than our standard reverse poppet thermostat. This helps return the thermostat to the closed position and prevent cold running even under the most adverse operating conditions.

# Ford 4 Cyl. Thermostat

This design thermostat used on most Ford 4 Cylinder engines does not include a traditional thermostat flange necessitating specific installation instructions. The Stant® 13820, 13828 , 13829, 45820, 45828, 45829 thermostats are the correct thermostat replacement although, in some cases, it may not resemble the original equipment Ford thermostat (see diagram). The uniquely designed Stant® 13820, 13828 , 13829, 45820, 45828, 45829 thermostats eliminates the need for the shroud (skirt) because the rubber seal eliminates any leakage from the side and top of the thermostat flange. Remember to lubricate the rubber seal slightly (coolant or anti-freeze is effective) when installing the thermostat. Insert the thermostat into the water outlet housing by pushing firmly on the bottom of the pellet (heat motor) to properly seat the thermostat.

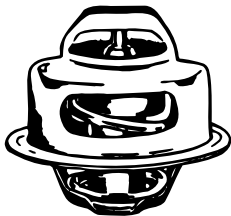
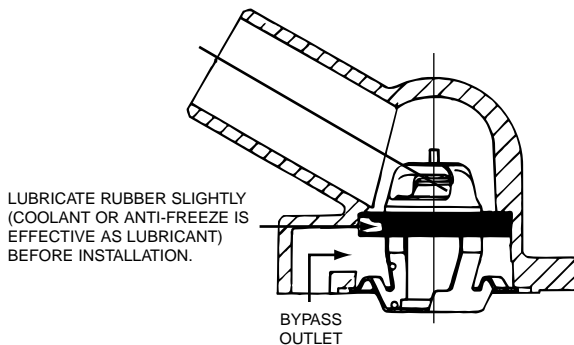

**ORIGINAL EQUIPMENT DESIGN**

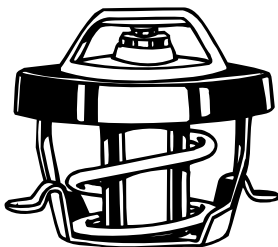

**STANT® DESIGN**

## Installation Instructions

**Stant® 13820, 13828 , 13829, 45820, 45828, 45829 Thermostats**

**Caution: Failure to comply with these instructions may result in serious injury.**

1. Allow cooling system to cool before servicing.
2. Prevent accidental starting of the engine by removing the ignition key.
3. Drain and flush cooling system.
4. Remove the outlet housing, thermostat, rubber seal and gasket.
5. Clean the gasket and seal mounting surfaces.
6. Insert the thermostat into the outlet housing, pushing firmly to properly seat the thermostat in the housing as shown in the illustration. Lubricate the rubber seal slightly (coolant or anti-freeze is effective) to help seat the thermostat in the housing.
7. Install new gasket by aligning bolt holes.
8. Replace outlet housing. Tighten bolts evenly.
9. Refill cooling system and run engine with radiator cap removed to normal operating temperature while checking for leaks.
10. After engine has reached normal operating temperature, shut off engine and allow engine to cool and recheck coolant level. Add coolant if needed. Test radiator pressure cap and replace if needed. Install radiator pressure cap.

# Offset Thermostats

Many Japanese and American car models now use the offset flange thermostat design as original equipment. These thermostats are equipped with a jiggle pin valve in the flange. This valve prevents air lock from occurring in the cooling system by allowing trapped air to escape while also reducing coolant leakage through the flange. Air lock and leakage hinder the operation of a thermostat during engine warm up. The offset design with the jiggle pin valve helps the engine to reach its designated operating temperature more quickly and precisely.

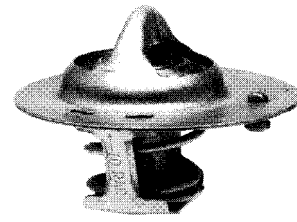
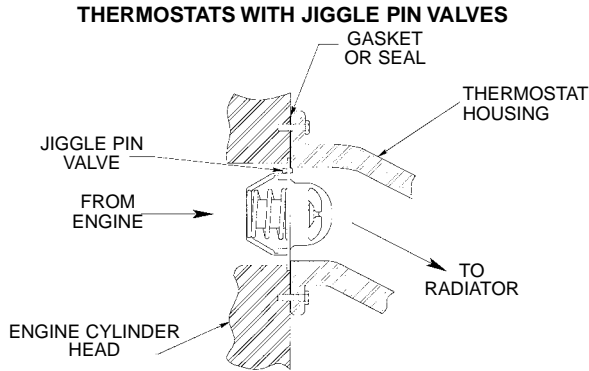

## Installation Instructions

### For Offset Thermostats With Jiggle Pin Valves

**Caution: Failure to comply with these instructions may result in serious injury.**

1. Allow cooling system to cool before servicing.
2. Prevent accidental starting of the engine by removing the ignition key.
3. Drain and flush cooling system.
4. Remove the outlet housing and take out old thermostat and gasket.
5. Clean gasket mounting surfaces.
6. Install thermostat so that the jiggle pin valve is positioned toward the high side of the housing with the copper pellet toward the engine (see installation sketch).
7. Install new gasket or rubber seal.
8. Replace outlet housing. Tighten bolts evenly.
9. Refill cooling system and run engine with radiator cap removed to normal operating temperature while checking for leaks.
10. After engine has reached normal operating temperature, shut off engine and allow engine to cool and recheck coolant level. Add coolant if needed. Test radiator pressure cap and replace if needed. Install radiator pressure cap.

# Rubber Seal Thermostats

Many of today's thermostats require a rubber seal which mounts to the flange. In most (but not all) of these thermostat designs the rubber seal replaces the conventional fiber composition gasket.

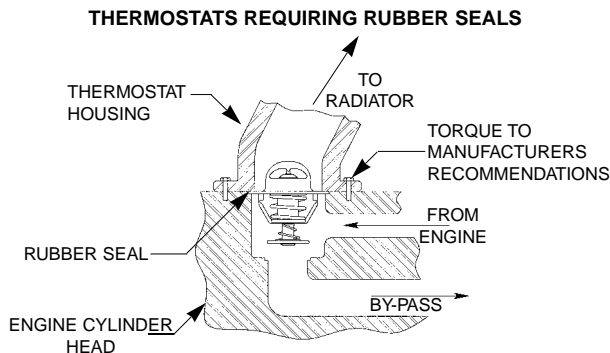

## Installation Instructions

### For Thermostats With Rubber Seals

**Caution: Failure to comply with these instructions may result in serious injury.**

1. Allow cooling system to cool before servicing.
2. Prevent accidental starting of the engine by removing the ignition key.
3. Drain and flush cooling system.
4. Remove the outlet housing and take out old thermostat and rubber seal.
5. Clean seal mounting surfaces.
6. Make sure rubber seal is installed on the thermostat flange. Insert the thermostat into the thermostat housing so that the copper pellet is toward the engine (see installation sketch).
7. Replace outlet housing. Tighten bolts evenly.
8. Refill cooling system and run engine with radiator cap removed to normal operating temperature while checking for leaks.
9. After engine has reached normal operating temperature, shut off engine and allow engine to cool and recheck coolant level. Add coolant if needed. Test radiator pressure cap and replace if needed. Install radiator pressure cap.

# Bypass Thermostats

This design of thermostats uses a bypass system to speed engine warm up. When the engine is cool the thermostat is closed. This allows coolant to circulate through the engine by way of a bypass canal located directly below the thermostat. As the engine warms up, the thermostat begins to open allowing coolant to pass through to the radiator. At the same time a lower poppet or bypass valve moves down to block the bypass canal. When the thermostat is fully open the bypass is fully blocked circulating all coolant through the radiator.



## Installation Instructions

### For Bypass Design Thermostats

**Caution: Failure to comply with these instructions may result in serious injury.**

1. Allow cooling system to cool before servicing.
2. Prevent accidental starting of the engine by removing the ignition key.
3. Drain and flush cooling system.
4. Remove the outlet housing and take out old thermostat and gasket.
5. Clean gasket mounting surfaces.
6. Install thermostat with copper pellet and bypass valve toward engine. (see installation sketch).
7. Install new gasket by aligning bolt holes.
8. Replace outlet housing. Tighten bolts evenly.
9. Refill cooling system and run engine with radiator cap removed to normal operating temperature while checking for leaks.
10. After engine has reached normal operating temperature, shut off engine and allow engine to cool and recheck coolant level. Add coolant if needed. Test radiator pressure cap and replace if needed. Install radiator pressure cap.

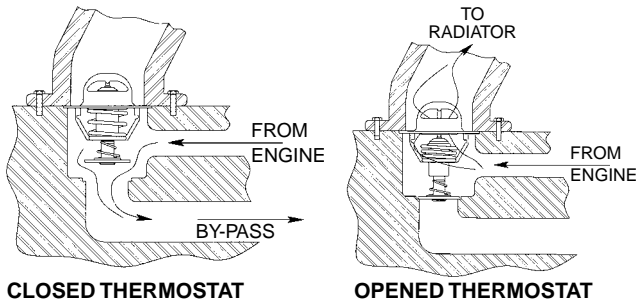

# GM Bracket Thermostat

This unique design thermostat is enclosed in a thermostat housing attached to the engine. A Stant® 10232 thermostat housing cap is located on top of the housing for easy access and quick replacement.

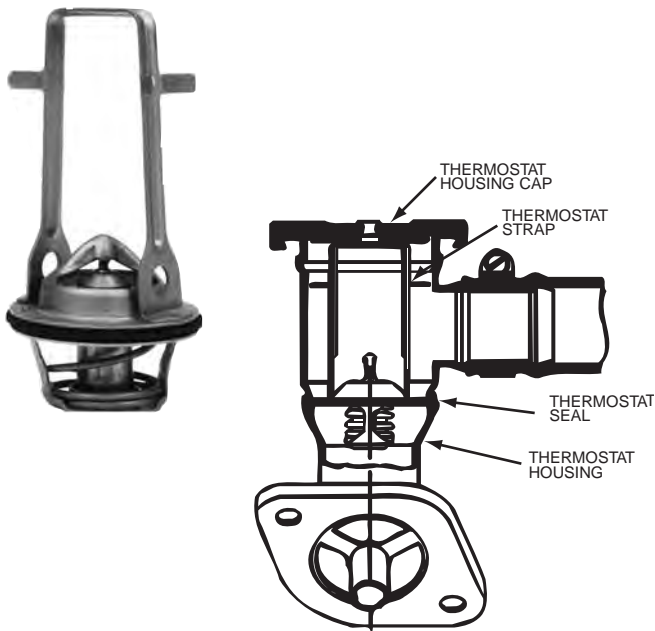

## Installation Instructions

### For GM Bracket Design Thermostats

**Caution: Failure to comply with these instructions may result in serious injury.**

1. Allow cooling system to cool before servicing.
2. Prevent accidental starting of the engine by removing the ignition key.
3. Do not attempt to remove the thermostat housing cap when engine is hot.
4. After the engine cools, turn the thermostat housing cap slowly counter-clockwise to remove. If there is any indication of pressure, stop immediately.
5. Remove the thermostat by grasping the thermostat strap and pulling upward.
6. Before installation of the new thermostat, make sure the thermostat sealing seat in the housing is clean and free of any solid material which will cause leakage. Recheck coolant level and add if necessary.
7. To install the new thermostat, lower the thermostat into the housing, using the thermostat strap as a handle. Make sure that you place the thermostat down into the housing, seating the thermostat. (No excessive force is needed.)
8. Replace the thermostat housing cap by turning clockwise. If the cap fails to seal the filler neck and leaks coolant, replace the cap.



# Thermostat with installation tool

Some thermostats are installed inside the water outlet housing and are held in place by two feet. An installation tube is used to compress the thermostat spring to aid in removing the OEM thermostat and installing the replacement Stant thermostat. Detailed removal and installation instructions are listed below



## REMOVAL

1. Cool engine, then drain coolant from the radiator and engine drain plug located at the right front of engine.
2. Disconnect lower radiator hose at thermostat housing.
3. Remove two bolts in water inlet housing.
4. Remove water inlet housing and thermostat assembly.
5. Remove the O-ring from the water inlet housing.  
**THE O-RING MUST BE REPLACED WHENEVER THE THERMOSTAT HOUSING IS REMOVED.**
6. Remove the thermostat assembly using the installation tube. Place the tube over the bypass disc and while pressing down on the frame rotate the tube to remove the thermostat assembly. Inspect the inlet water housing for any damage.

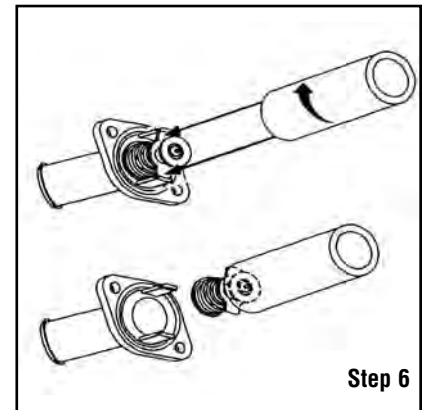
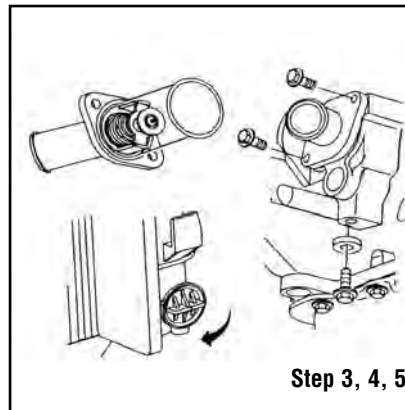
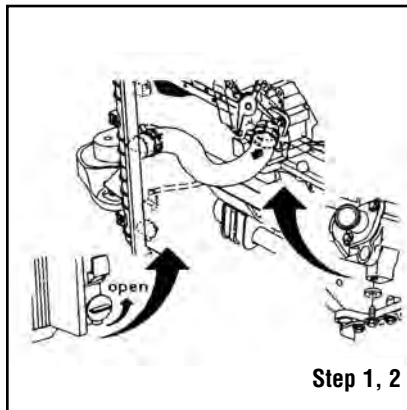

## INSTALLATION

1. Install the thermostat assembly into the water inlet housing using the installation tube. Push down on the frame and rotate the tube to seat the frame into the slots in the inlet water housing.  
**MAKE SURE THE THERMOSTAT ASSEMBLY RETAINING FRAMES ARE PROPERLY SEATED IN THE HOUSING AND THE PISTON OF THE THERMOSTAT ASSEMBLY IS PROPERLY POSITIONED IN THE WATER INLET HOUSING.**
2. Install a new O-ring into the inlet housing.
3. Install the inlet water housing into the block.
4. Install the bolts and tighten.
5. Re-install the cylinder block drain plug and close the radiator drain plug.
6. Connect the lower radiator hose to the inlet housing.  
**MAKE SURE THE VEHICLE IS ON LEVEL GROUND WHEN FILLING THE COOLING SYSTEM**
7. Refill the system with coolant.
8. Start the engine and run engine with heater on until the thermostat opens. Refill system, replace the radiator cap and fill the coolant surge tank to the full cold line.
9. Check for any leaks.

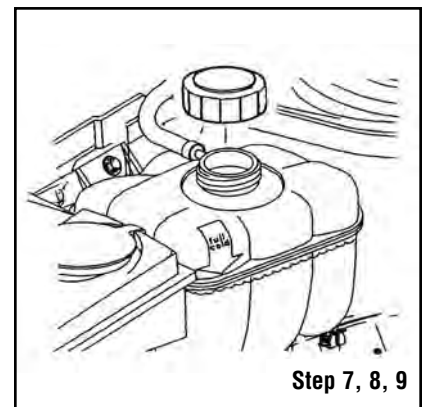
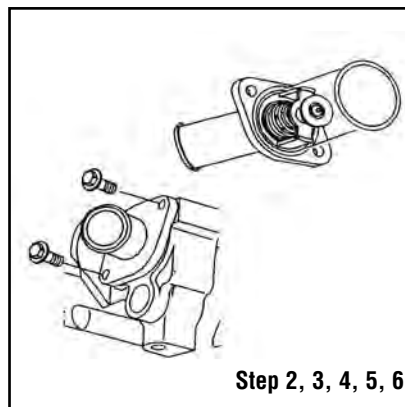
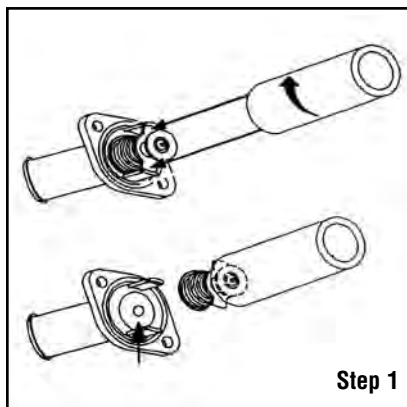

# WATER OUTLET GASKETS AND SEALS

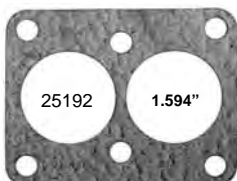
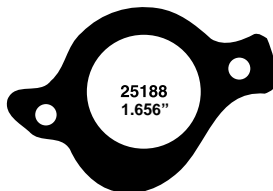
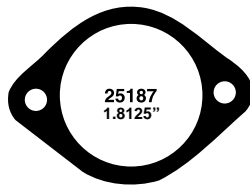
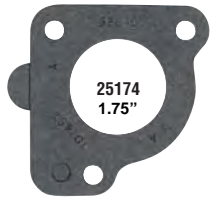
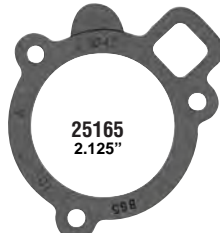
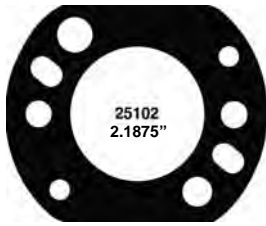
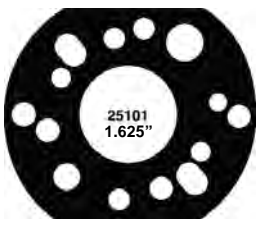

# WATER OUTLET GASKETS AND SEALS

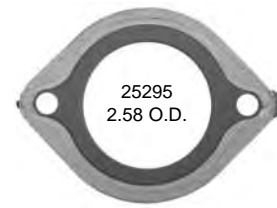

SEAL #	O.D.	I.D.	Height	STYLE
25010	1.906	1.609	0.25	Metal Clad
25020	2.672	2.265	0.25	Metal Clad
25030	2.141	1.797	0.25	Metal Clad
25040	2.234	1.625	0.25	Metal Clad
25259	2	1.625	0.094	Square Cut
25262	1.875	1.468	0.156	Square Cut
25266	2.094	1.8125	0.094	Square Cut
25269	2.25	1.9375	0.156	O-Ring
25270	2.1875	1.797	0.172	Grooved, Square Cut
25271	2.64	2.359	0.141	O-Ring
25272	1.922	1.719	0.125	Grooved, Chamfered I.D.
25273	1.641	1.5625	0.266	Grooved, Molded
25276	2.406	1.844	0.218	Grooved, Molded
25277	1.469	1.078	0.109	Molded
25278	2.281	2	0.172	Grooved, Molded
25279	2.203	1.828	0.25	Grooved, Molded
25280	2	1.719	0.266	Grooved, Chamfered O.D.
25281	2.156	1.906	0.265	Grooved, Chamfered I.D.
25282	2.3125	1.953	0.156	Grooved, Chamfered I.D.
25283	2.6875	2.375	0.212	Grooved, Molded
25284	2.078	1.766	0.219	Grooved, Molded
25285	2.219	1.9375	0.219	Grooved, Molded
25286	2.359	2.0625	0.219	Grooved, Molded
25287	2.344	1.859	0.641	Rectangular
25288	1.984	1.609	0.25	Grooved, Molded
25289	2.563	2.344	0.125	Square Cut
25290	2.266	1.984	0.141	O-Ring
25291	2.468	2.1875	0.156	Square Cut
25292	2.468	2	0.563	Lathe Cut, Stepped
25297		1.875		Grooved, Molded
25298	2.719	2.531	0.25	Grooved
25299	1.844	1.5	0.25	Grooved
25300	2.3125	2.156	0.25	O-Ring

# THERMOSTAT NUMERICAL LISTING

Use as a guide only. Refer to application section for specific vehicle.

13006 160°F | 13008 180°F | 13009 195°F

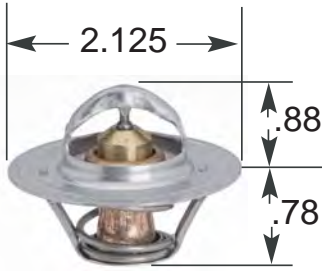

13366 160°F | 13368 180°F | 13369 195°F

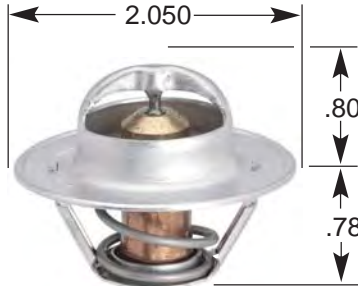

13436 160°F



13019 190°F

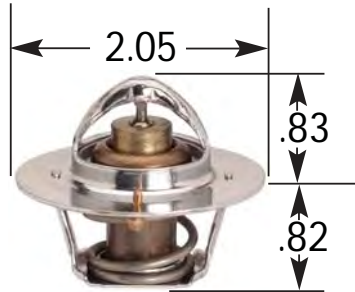

13376 160°F | 13378 180°F | 13379 195°F

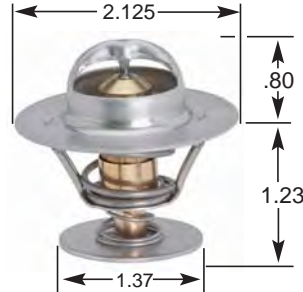

13446 160°F | 13447 170°F | 13448 180°F

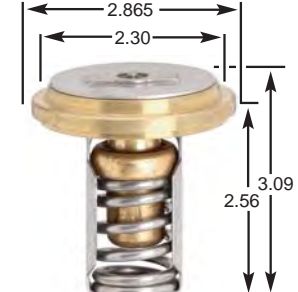

13076 160°F | 13078 180°F | 13079 195°F

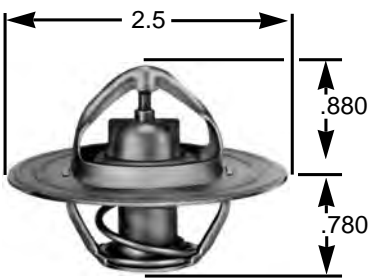

13388 180°F | 13389 195°F

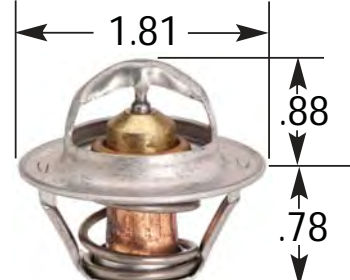

13458 180°F | 13459 195°F

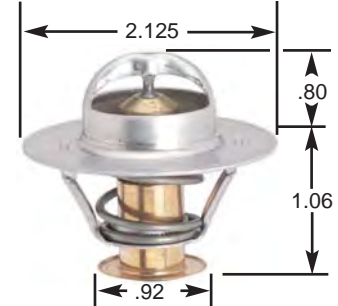

13348 180°F | 13349 195°F

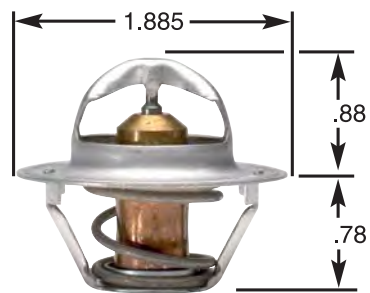

13398 180°F | 13399 195°F

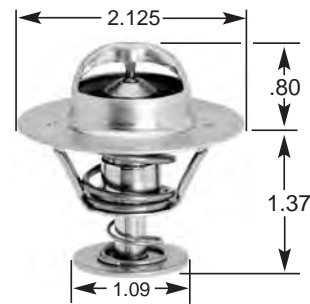

13468 180°F | 13469 195°F

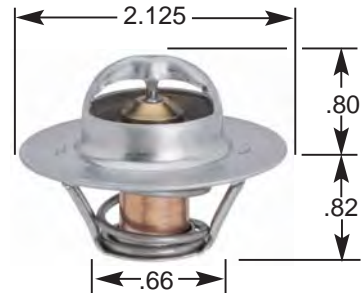

13352 205°F | 13356 160°F | 13358 180°F  
13359 195°F

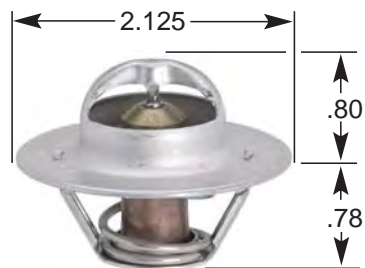

13429 195°F

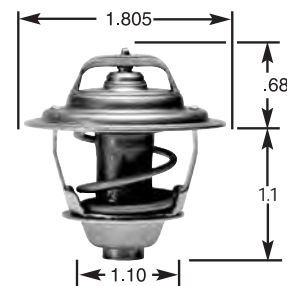

13476 160°F | 13478 180°F | 13479 195°F

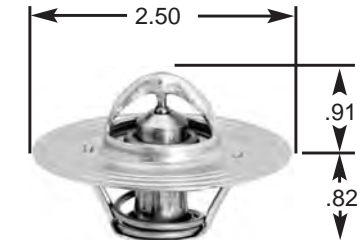

# THERMOSTAT NUMERICAL LISTING (CONTINUED)

Use as a guide only. Refer to application section for specific vehicle.

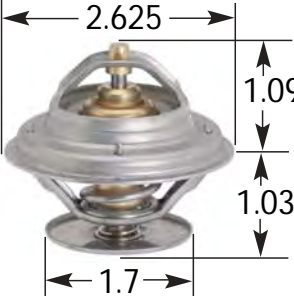
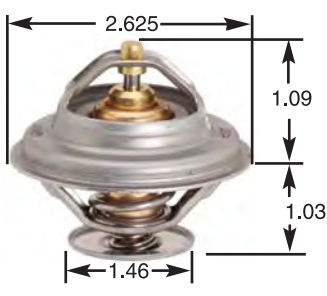
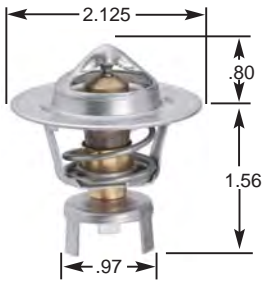
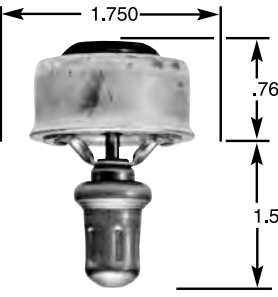
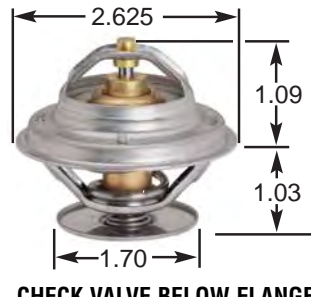
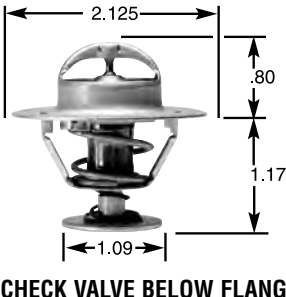
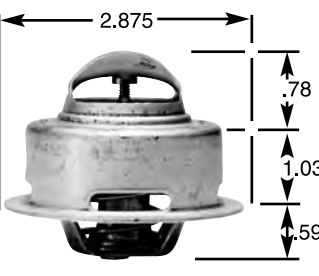
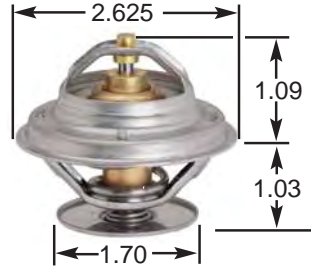
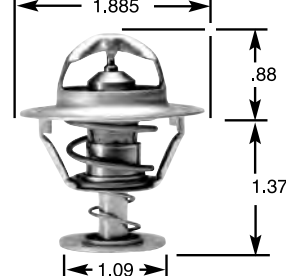
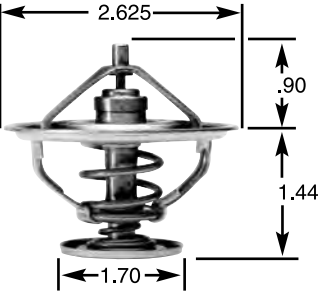
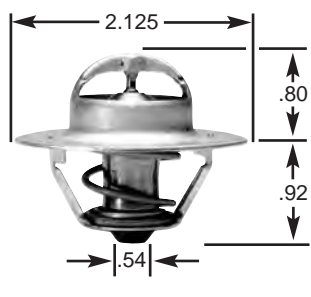
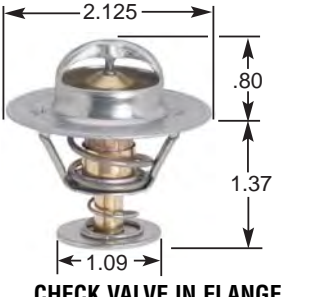
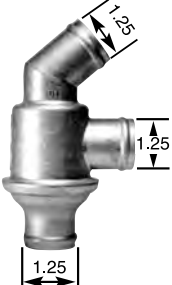
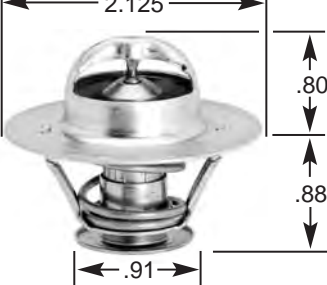
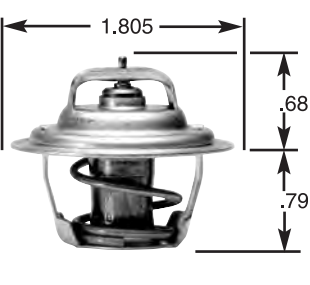
<p><b>13496 160°F</b></p> 	<p><b>13588 176°F</b></p> 	<p><b>13738 180°F   13739 195°F</b></p> 
<p><b>13518 180°F   13519 195°F</b></p> 	<p><b>13648 180°F   13649 190°F</b></p>  <p><b>CHECK VALVE BELOW FLANGE</b></p>	<p><b>13748 180°F   13749 195°F</b></p>  <p><b>CHECK VALVE BELOW FLANGE</b></p>
<p><b>13548 180°F   13549 192°F</b></p> 	<p><b>13696 160°F   13697 170°F   13698 180°F</b></p> 	<p><b>13758 180°F</b></p> 
<p><b>13558 180°F</b></p> 	<p><b>13716 160°F   13718 180°F</b></p> 	<p><b>13778 180°F   13779 195°F</b></p>  <p><b>CHECK VALVE IN FLANGE</b></p>
<p><b>13578 180°F</b></p> 	<p><b>13726 160°F   13728 180°F</b></p> 	<p><b>13788 180°F   13789 195°F</b></p> 

# THERMOSTAT NUMERICAL LISTING (CONTINUED)

Use as a guide only. Refer to application section for specific vehicle.

13798 180°F

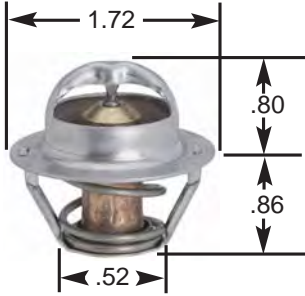

13868 180°F | 13869 195°F

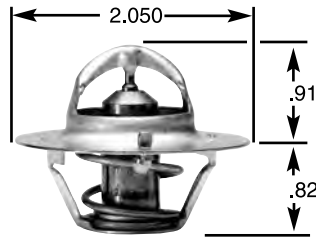

JIGGLE PIN VALVE IN FLANGE

13918 180°F | 13919 195°F

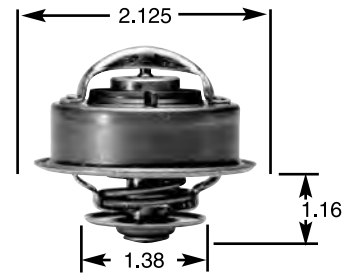

13818 180°F | 13819 195°F

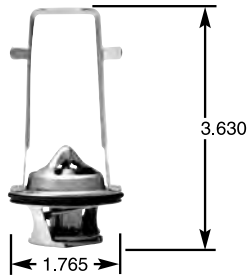

13874 140°F | 13878 180°F | 13879 195°F

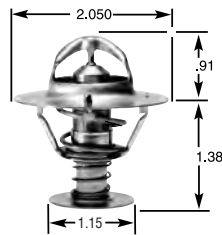

JIGGLE PIN VALVE IN FLANGE

13926 160°F | 13928 180°F

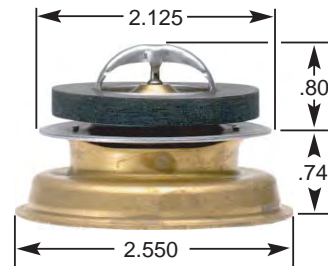

13820 192°F | 13828 180°F | 13829 195°F

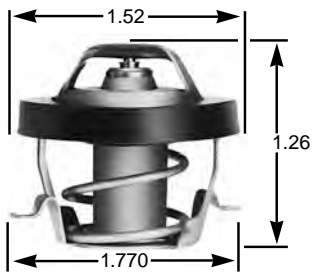

13889 195°F

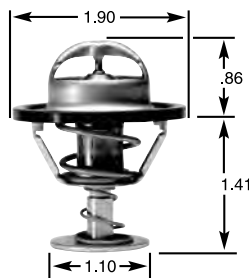

13938 180°F

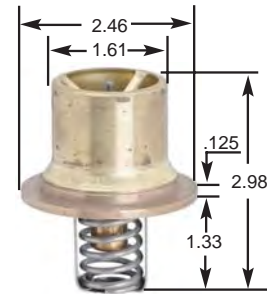

13848 180°F | 13849 195°F

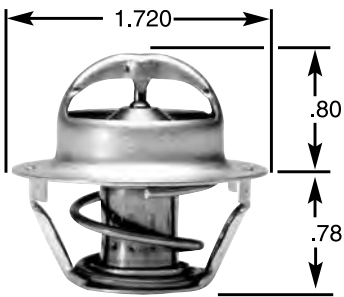

13899 195°F

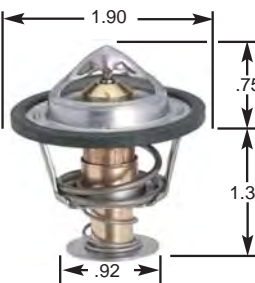

13944 140°F | 13947 170°F | 13948 180°F

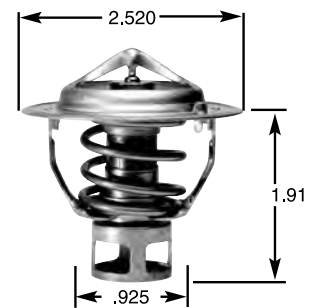

13858 180°F | 13859 195°F

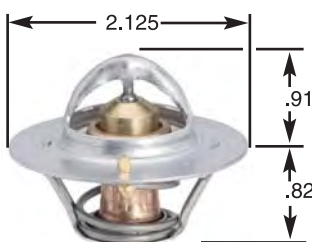

JIGGLE PIN VALVE IN FLANGE

13908 180°F

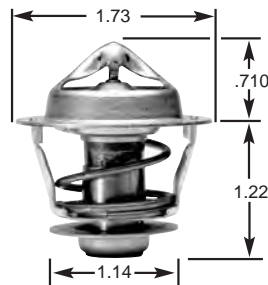

13958 180°F | 13959 195°F

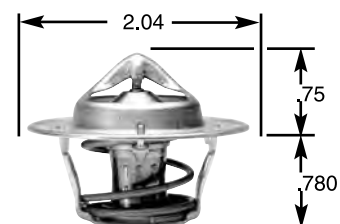

JIGGLE PIN VALVE IN FLANGE

# THERMOSTAT NUMERICAL LISTING (CONTINUED)

Use as a guide only. Refer to application section for specific vehicle.

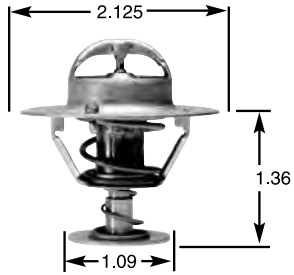
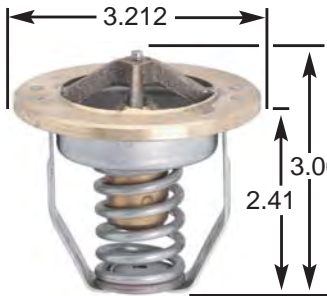
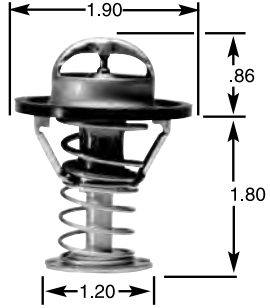
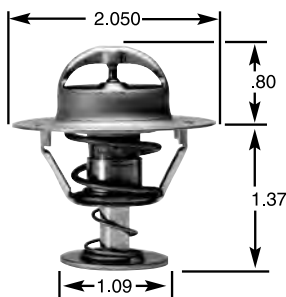
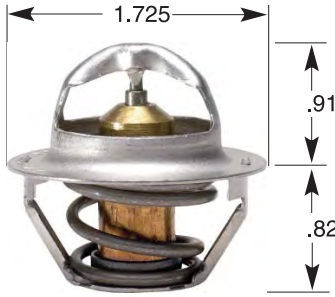
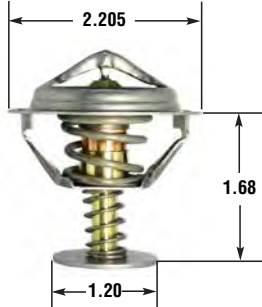
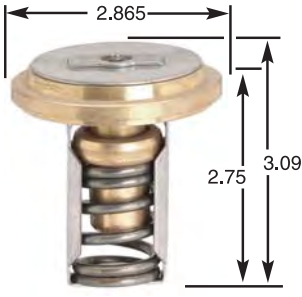
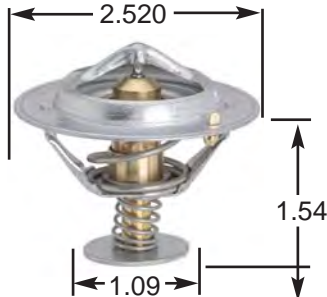
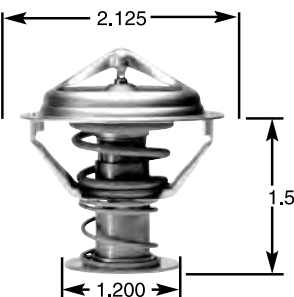
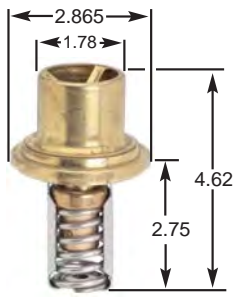
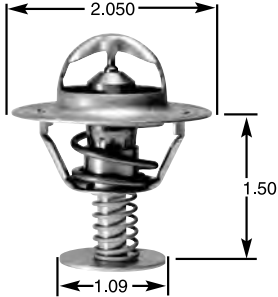
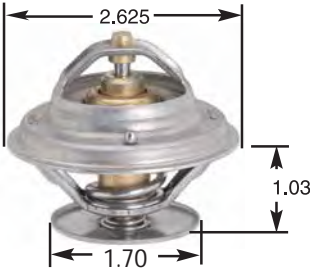
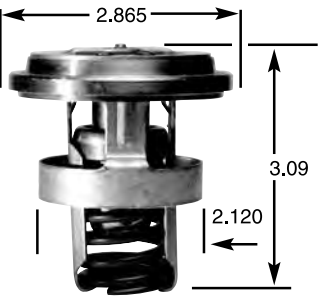
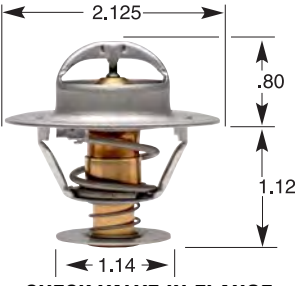
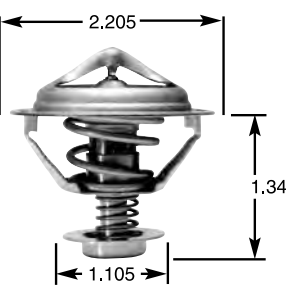
<p><b>13967 170°F   13968 180°F</b></p>  <p>2.125 1.36 1.09</p> <p><b>JIGGLE PIN VALVE IN FLANGE</b></p>	<p><b>14017 180°F   14018 195°F</b></p>  <p>3.212 3.06 2.41</p>	<p><b>14068 180°F</b></p>  <p>1.90 .86 1.80 1.20</p>
<p><b>13974 140°F   13978 180°F   13979 195°F</b></p>  <p>2.050 .80 1.37 1.09</p>	<p><b>14028 180°F</b></p>  <p>1.725 .91 .82</p>	<p><b>14074 140°F   14077 170°F   14078 180°F</b></p>  <p>2.205 1.68 1.20</p>
<p><b>13987 170°F</b></p>  <p>2.865 2.75 3.09</p>	<p><b>14039 195°F</b></p>  <p>2.520 1.54 1.09</p>	<p><b>14089 188°F</b></p>  <p>2.125 1.59 1.200</p>
<p><b>13998 180°F</b></p>  <p>2.865 1.78 4.62 2.75</p>	<p><b>14047 170°F   14048 180°F</b></p>  <p>2.050 1.50 1.09</p>	<p><b>14099 187°F</b></p>  <p>2.625 1.03 1.70</p> <p><b>CHECK VALVE ABOVE FLANGE</b></p>
<p><b>14007 170°F   14008 180°F</b></p>  <p>2.865 3.09 2.120</p>	<p><b>14058 180°F</b></p>  <p>2.125 .80 1.12 1.14</p> <p><b>CHECK VALVE IN FLANGE</b></p>	<p><b>14104 140°F   14108 180°F</b></p>  <p>2.205 1.34 1.105</p>

# THERMOSTAT NUMERICAL LISTING (CONTINUED)

Use as a guide only. Refer to application section for specific vehicle.

<p><b>14119 195°F</b></p>	<p><b>14168 180°F</b></p>	<p><b>14228 180°F</b></p> <p><b>MAY NEED TO COMPRESS TO INSTALL</b></p>
<p><b>14127 170°F   14128 180°F</b></p>	<p><b>14177 170°F   14178 180°F</b></p>	<p><b>14239 190°F</b></p>
<p><b>14138 180°F   14139 188°F</b></p>	<p><b>14188 180°F</b></p> <p><b>CHECK VALVE BELOW FLANGE</b></p>	<p><b>14248 180°F</b></p>
<p><b>14144 140°F   14147 170°F</b></p>	<p><b>14209 195°F</b></p> <p><b>JIGGLE PIN VALVE IN FLANGE</b></p>	<p><b>14252 205°F   14259 195°F</b></p>
<p><b>14157 170°F</b></p>	<p><b>14218 180°F</b></p>	<p><b>14269 195°F</b></p>



# THERMOSTAT NUMERICAL LISTING (CONTINUED)

Use as a guide only. Refer to application section for specific vehicle.

<p><b>14279 188°F</b></p>  <p>Dimensions: 1.20 (width), 1.26 (height), 1.42 (width)</p>	<p><b>14337 170°F</b></p>  <p>Dimensions: 2.66 (width), 1.68 (height), 1.20 (width)</p>	<p><b>14389 190°F</b></p>  <p>Dimensions: 2.20 (width), .70 (height), 1.625 (height), 1.20 (width)</p>
<p><b>14288 180°F   14289 190°F</b></p>  <p>Dimensions: 2.39 (width), 1.10 (height), .77 (width)</p> <p><b>JIGGLE PIN VALVE IN FLANGE</b></p>	<p><b>14349 190°F</b></p>  <p>Dimensions: 2.12 (width), .84 (height), 1.03 (height)</p> <p><b>CHECK VALVE ABOVE FLANGE</b></p>	<p><b>14399 190°F</b></p>  <p>Dimensions: 2.30 (width), .68 (height), .87 (height)</p>
<p><b>14298 186°F</b></p>  <p>Dimensions: 1.33 (width), 1.88 (height), 1.45 (width), 2.55 (width)</p>	<p><b>14358 180°F</b></p>  <p>Dimensions: 1.89 (width), .79 (height), .83 (height)</p> <p><b>JIGGLE PIN VALVE IN FLANGE</b></p>	<p><b>14406 160°F   14407 170°F   14408 180°F</b></p>  <p>Dimensions: 2.460 (width), 1.61 (width), .06 (height), 3.00 (height), 1.42 (height)</p>
<p><b>14318 180°F</b></p>  <p>Dimensions: 1.20 (width), 1.13 (height), 1.20 (width), 4.17 (width)</p>	<p><b>14368 180°F   14369 195°F</b></p>  <p>Dimensions: 2.23 (width), .83 (height), .77 (height)</p> <p><b>CHECK VALVE ABOVE FLANGE</b></p>	<p><b>14419 190°F</b></p>  <p>Dimensions: 2.125 (width), .81 (height), .812 (height)</p>
<p><b>14327 170°F</b></p>  <p>Dimensions: 2.35 (width), 1.44 (height)</p>	<p><b>14378 180°F</b></p>  <p>Dimensions: 2.05 (width), .83 (height), .83 (height)</p> <p><b>JIGGLE PIN VALVE IN FLANGE</b></p>	<p><b>14429 190°F</b></p>  <p>Dimensions: 2.49 (width), .84 (height), .72 (height)</p>

# THERMOSTAT NUMERICAL LISTING (CONTINUED)

Use as a guide only. Refer to application section for specific vehicle.

14458 180°F

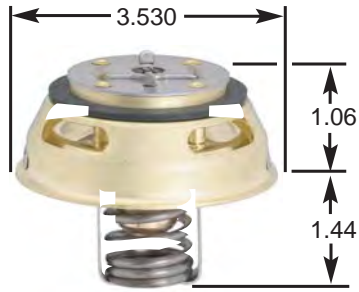

14589 180°F



CHECK VALVE IN FLANGE

14632 203°F

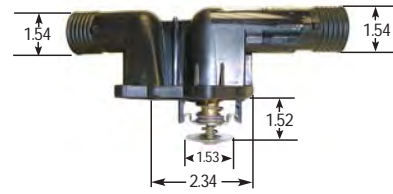

CHECK VALVE IN FLANGE

14536 160°F | 14537 170°F | 14538 180°F | 14539 190°F

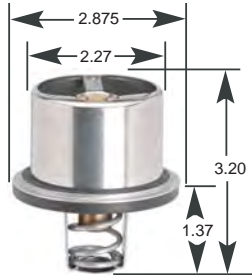

14598 176°F



CHECK VALVE IN FLANGE

14648 180°F

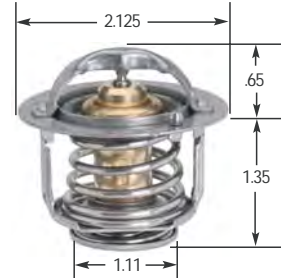

JIGGLE PIN VALVE IN FLANGE

14558 180°F | 14559 190°F



14602 206°F

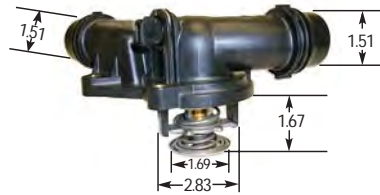

14659 190°F



CHECK VALVE IN FLANGE

14569 188°F



14612 221°F

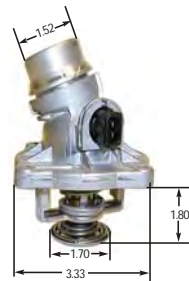

CHECK VALVE IN FLANGE

14664 140°F | 14668 180°F

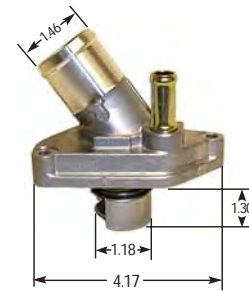

JIGGLE PIN VALVE IN FLANGE

14578 176°F

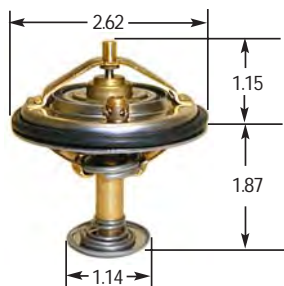

CHECK VALVE IN FLANGE

14622 198°F

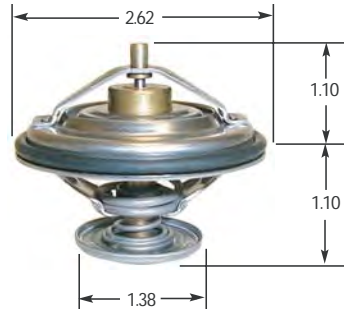

14678 180°F

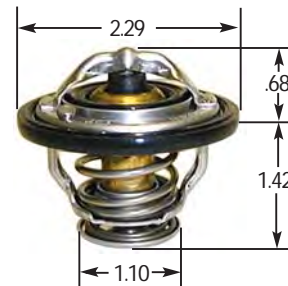

JIGGLE PIN VALVE IN FLANGE

# THERMOSTAT NUMERICAL LISTING (CONTINUED)

Use as a guide only. Refer to application section for specific vehicle.

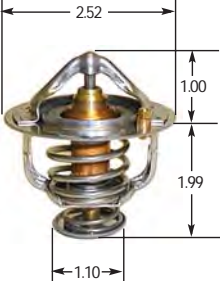
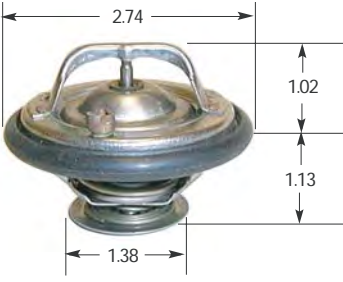
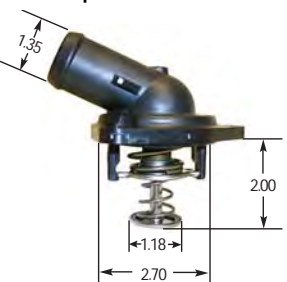
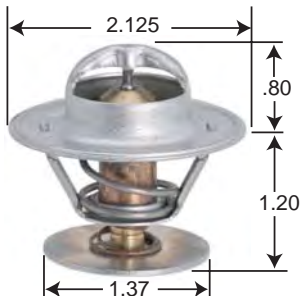
<p><b>14687 170°F</b></p>  <p><b>JIGGLE PIN VALVE IN FLANGE</b></p>	<p><b>14738 180°F</b></p>  <p><b>CHECK VALVE ABOVE FLANGE</b></p>	<p><b>14789 195°F</b></p>  <p><b>CHECK VALVE ABOVE FLANGE</b></p>
<p><b>14698 180°F</b></p> 	<p><b>14748 183°F</b></p>  <p><b>CHECK VALVE ABOVE FLANGE</b></p>	<p><b>14798 180°F</b></p>  <p><b>CHECK VALVE ABOVE FLANGE</b></p>
<p><b>14707 170°F</b></p>  <p><b>JIGGLE PIN VALVE IN FLANGE</b></p>	<p><b>14754 140°F   14757 172°F</b></p>  <p><b>JIGGLE PIN VALVE IN FLANGE</b></p>	<p><b>14808 180°F</b></p>  <p><b>JIGGLE PIN VALVE IN FLANGE</b></p>
<p><b>14719 190°F</b></p>  <p><b>JIGGLE PIN VALVE IN FLANGE</b></p>	<p><b>14768 180°F</b></p>  <p><b>JIGGLE PIN VALVE IN FLANGE</b></p>	<p><b>14818 180°F</b></p>  <p><b>JIGGLE PIN VALVE IN FLANGE</b></p>
<p><b>14728 185°F</b></p> 	<p><b>14778 180°F</b></p>  <p><b>JIGGLE PIN VALVE IN FLANGE</b></p>	<p><b>14838 180°F   14839 190°F</b></p> 





# THERMOSTAT NUMERICAL LISTING (CONTINUED)

Use as a guide only. Refer to application section for specific vehicle.

<p><b>14857 175°F</b></p>  <p>Dimensions: 3.20 (width), 1.94 (inner width), 1.76 (height), .88 (flange thickness)</p>	<p><b>14917 175°F</b></p>  <p>Dimensions: 1.93 (width), 1.23 (height), 2.13 (total height)</p>	<p><b>14968 186°F</b></p>  <p>Dimensions: 2.21 (width), 1.00 (height)</p>
<p><b>14868 180°F</b></p>  <p>Dimensions: 3.08 (width), 1.23 (height), 1.52 (total height)</p>	<p><b>14928 180°F</b></p>  <p>Dimensions: 2.58 (width), 3.96 (height)</p>	<p><b>14978 180°F</b></p>  <p>Dimensions: 1.70 (width), 1.36 (height)</p>
<p><b>14889 190°F</b></p>  <p>Dimensions: 3.33 (width), 3.36 (height)</p>	<p><b>14936 160°F</b></p>  <p>Dimensions: 2.58 (width), 3.96 (height)</p>	<p><b>14989 192°F</b></p>  <p>Dimensions: 2.125 (width), .93 (height), 1.22 (total height), 1.37 (base width)</p> <p><b>CHECK VALVE ABOVE FLANGE</b></p>
<p><b>14899 192°F</b></p>  <p>Dimensions: 3.50 (width), 3.55 (height)</p>	<p><b>14948 186°F</b></p>  <p>Dimensions: 2.27 (width), 1.82 (height), 2.77 (total height)</p>	<p><b>14990 192°F</b></p>  <p>Dimensions: 1.50 (width), .50 (height), .80 (total height)</p>
<p><b>14908 181°F</b></p>  <p>Dimensions: 2.875 (width), 3.375 (height)</p>	<p><b>14959 188°F</b></p>  <p>Dimensions: 2.21 (width), 2.91 (height)</p>	<p><b>15006 160°F   15008 180°F   15009 190°F</b></p>  <p>Dimensions: 3.21 (width), 1.83 (height), 1.25 (total height)</p>

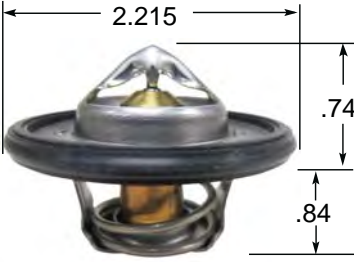
# THERMOSTAT NUMERICAL LISTING (CONTINUED)

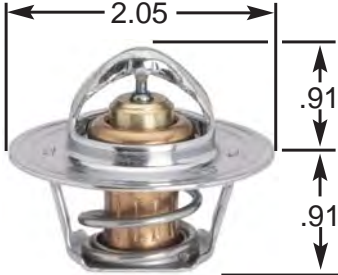
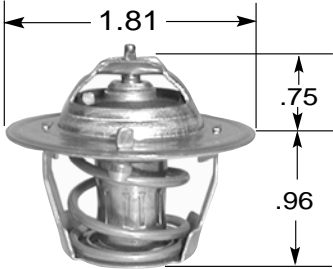
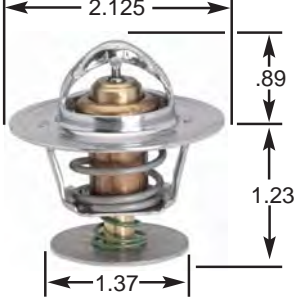
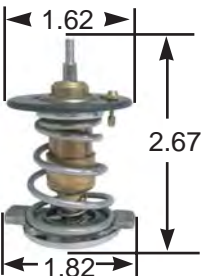
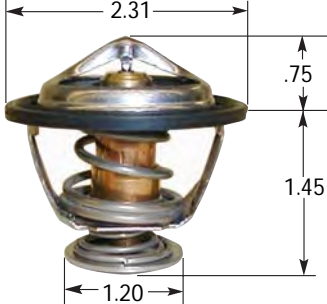
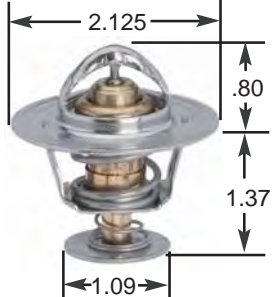
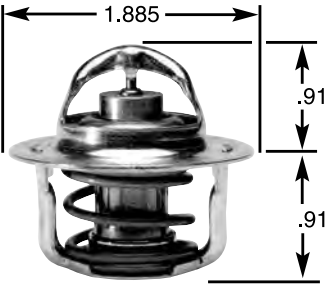
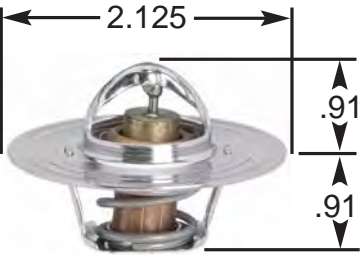
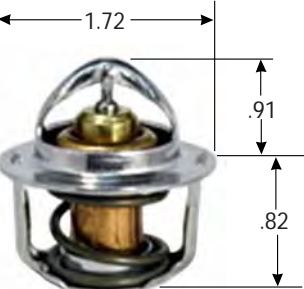
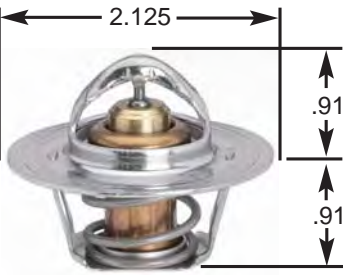
Use as a guide only. Refer to application section for specific vehicle.

<p><b>15112 205°F</b></p> 	<p><b>45119 195°F</b></p> 	<p><b>45368 180°F   45369 195°F</b></p> 
<p><b>15138 180°F</b></p> 	<p><b>45209 192°F</b></p>  <p>JIGGLE PIN VALVE IN FLANGE</p>	<p><b>45378 180°F   45379 195°F</b></p> 
<p><b>15148 180°F</b></p> 	<p><b>45218 180°F</b></p> 	<p><b>45398 180°F   45399 195°F</b></p> 
<p><b>15158 180°F</b></p> 	<p><b>45348 180°F   45349 195°F</b></p> 	<p><b>45478 180°F   45479 195°F</b></p> 
<p><b>45028 180°F</b></p> 	<p><b>45356 160°F   45358 180°F   45359 195°F</b></p> 	<p><b>45758 180°F</b></p> 

# THERMOSTAT NUMERICAL LISTING (CONTINUED)

Use as a guide only. Refer to application section for specific vehicle.

45778 180°F | 45779 192°F

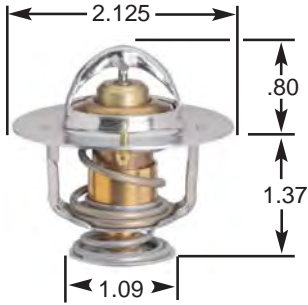

45858 180°F | 45859 195°F

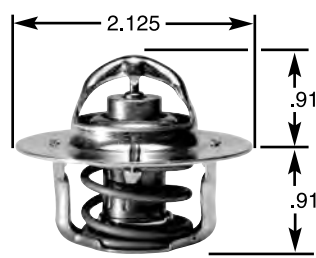

JIGGLE PIN VALVE IN FLANGE

45947 170°F | 45948 180°F

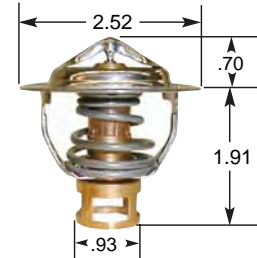

JIGGLE PIN VALVE IN FLANGE

45788 180°F | 45789 195°F

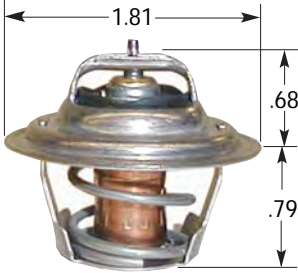

JIGGLE PIN IN VALVE

45868 180°F | 45869 195°F

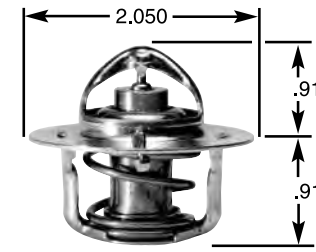

JIGGLE PIN VALVE IN FLANGE

45967 170°F

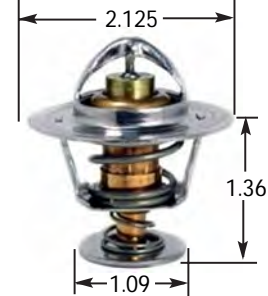

45818 180°F | 45819 195°F



45877 170°F | 45878 180°F | 45879 195°F

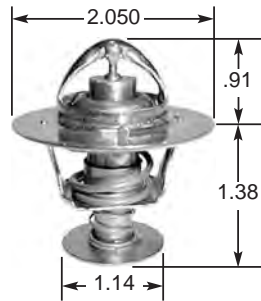

45978 180°F | 45979 195°F

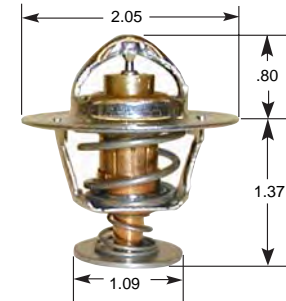

45820 192°F | 45828 180°F | 45829 195°F

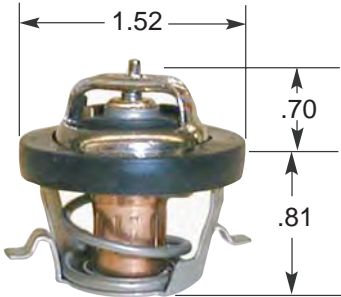

45889 195°F

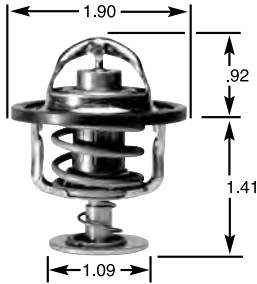

45990 192°F

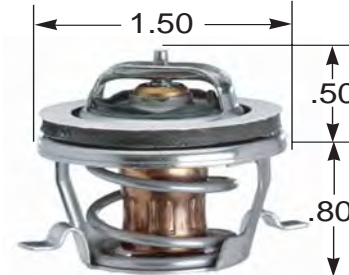

45848 180°F | 45849 195°F

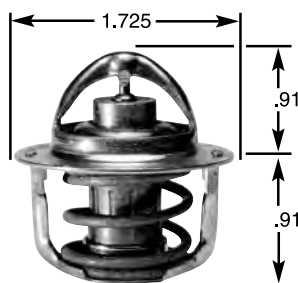

45899 195°F

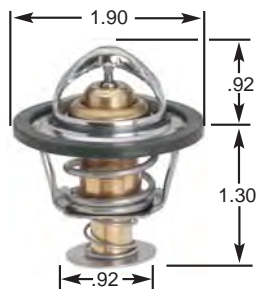

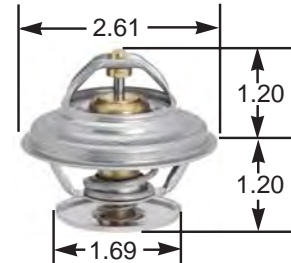

48019 189°F



CHECK VALVE IN FLANGE

# THERMOSTAT NUMERICAL LISTING (CONTINUED)

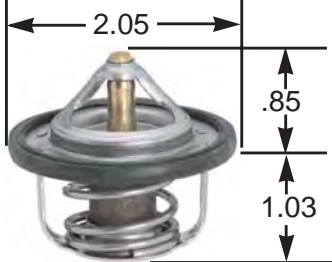
Use as a guide only. Refer to application section for specific vehicle.

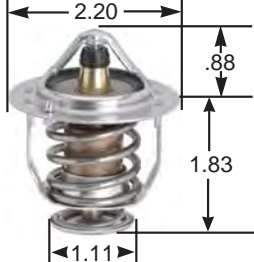
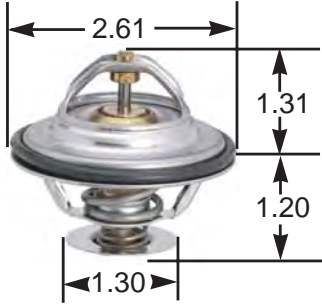
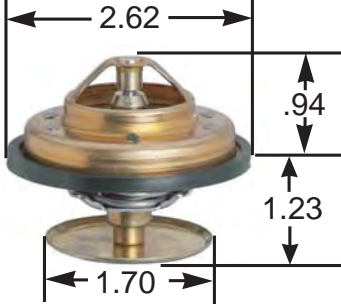
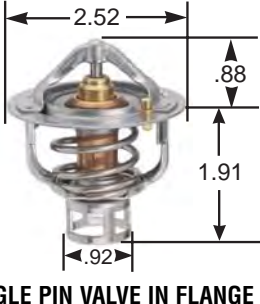
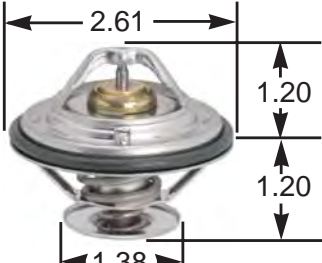
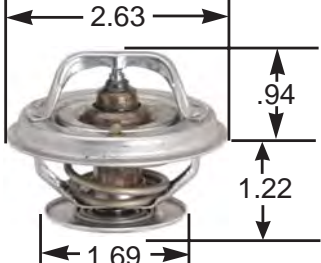
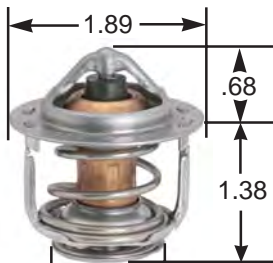
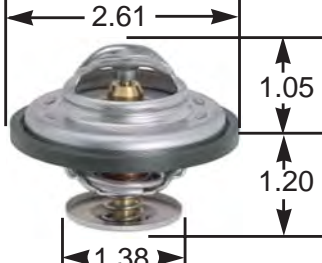
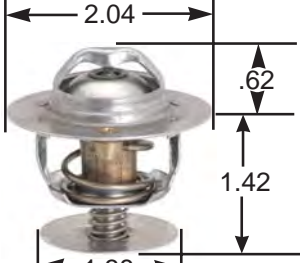
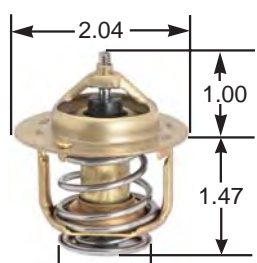
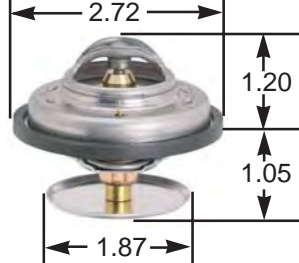
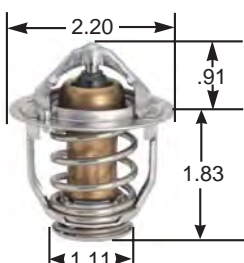
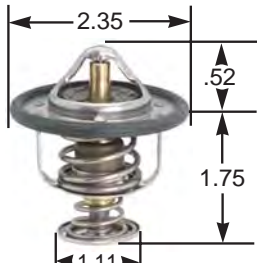
<p><b>48028 180°F</b></p>  <p><b>JIGGLE PIN VALVE IN FLANGE</b></p>	<p><b>48078 180°F</b></p>  <p><b>JIGGLE PIN VALVE IN FLANGE</b></p>	<p><b>48128 180°F</b></p>  <p><b>JIGGLE PIN VALVE IN FLANGE</b></p>
<p><b>48038 176°F</b></p> 	<p><b>48089 197°F</b></p> 	<p><b>48138 180°F</b></p>  <p><b>JIGGLE PIN VALVE IN FLANGE</b></p>
<p><b>48049 189°F</b></p>  <p><b>CHECK VALVE IN FLANGE</b></p>	<p><b>48099 198°F</b></p>  <p><b>JIGGLE PIN VALVE IN FLANGE</b></p>	<p><b>48148 180°F</b></p>  <p><b>JIGGLE PIN VALVE IN FLANGE</b></p>
<p><b>48058 176°F</b></p> 	<p><b>48109 198°F</b></p>  <p><b>CHECK VALVE IN FLANGE</b></p>	<p><b>48158 180°F</b></p>  <p><b>JIGGLE PIN VALVE IN FLANGE</b></p>
<p><b>48069 195°F</b></p>  <p><b>JIGGLE PIN VALVE IN FLANGE</b></p>	<p><b>48118 180°F</b></p>  <p><b>JIGGLE PIN VALVE IN FLANGE</b></p>	<p><b>48168 180°F</b></p>  <p><b>JIGGLE PIN VALVE IN FLANGE</b></p>

# THERMOSTAT NUMERICAL LISTING (CONTINUED)

Use as a guide only. Refer to application section for specific vehicle.

48177 170°F

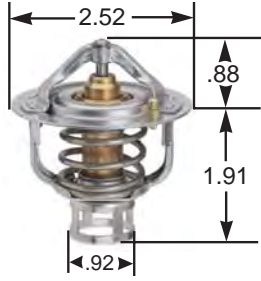

JIGGLE PIN VALVE IN FLANGE

48239 190°F

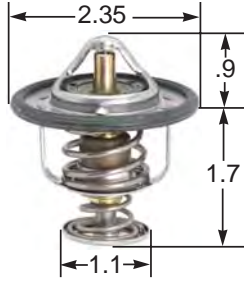

JIGGLE PIN VALVE IN FLANGE

48288 180°F

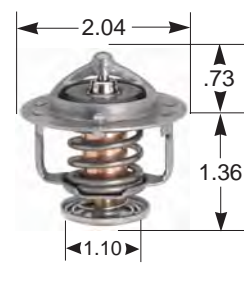

JIGGLE PIN VALVE IN FLANGE

48187 170°F

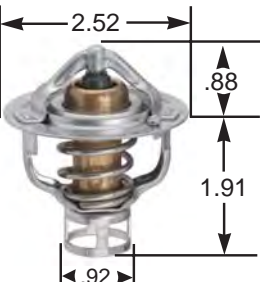

JIGGLE PIN VALVE IN FLANGE

48247 170°F

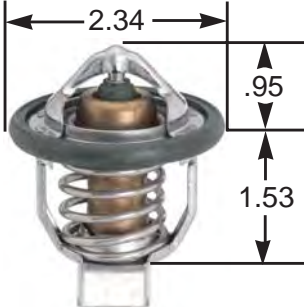

48298 180°F

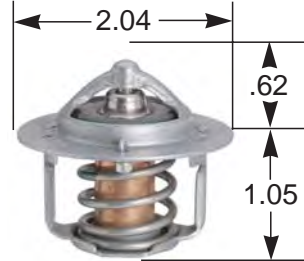

JIGGLE PIN VALVE IN FLANGE

48197 170°F

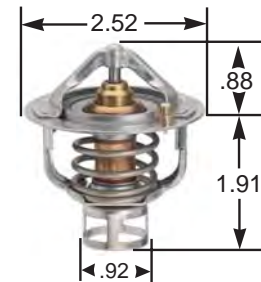

JIGGLE PIN VALVE IN FLANGE

48258 180°F

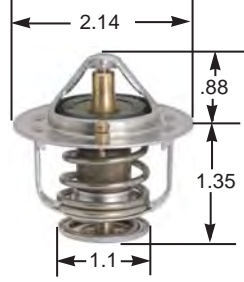

JIGGLE PIN VALVE IN FLANGE

48308 180°F

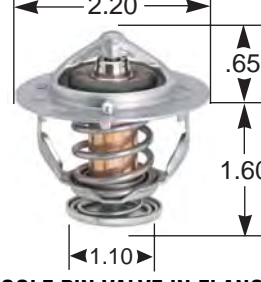

JIGGLE PIN VALVE IN FLANGE

48217 170°F

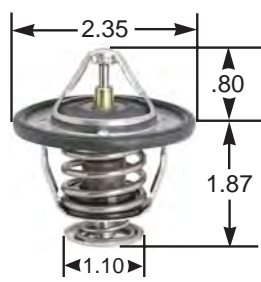

JIGGLE PIN VALVE IN FLANGE

48268 180°F

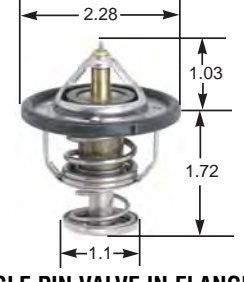

JIGGLE PIN VALVE IN FLANGE

48319 190°F

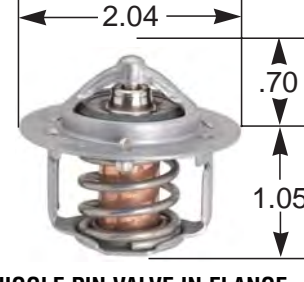

JIGGLE PIN VALVE IN FLANGE

48227 170°F

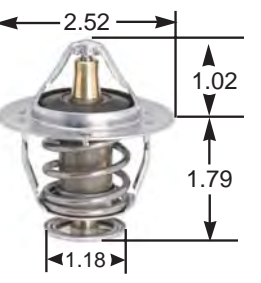

JIGGLE PIN VALVE IN FLANGE

48278 180°F

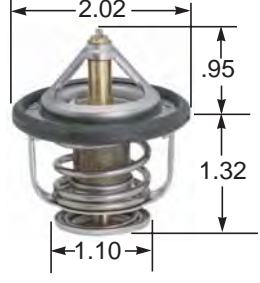

JIGGLE PIN VALVE IN FLANGE

48327 170°F

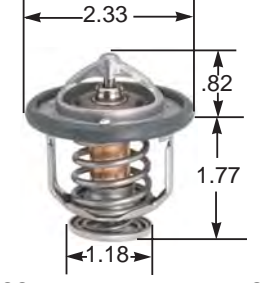







JIGGLE PIN VALVE IN FLANGE

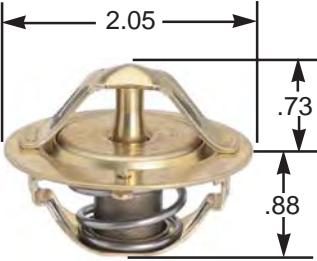
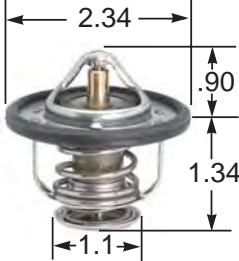
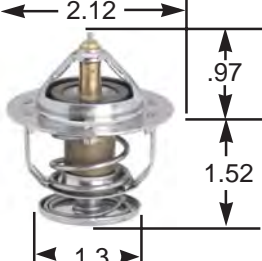
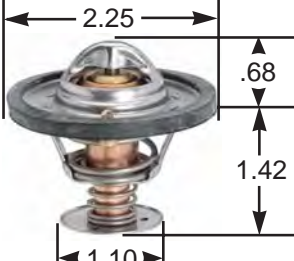
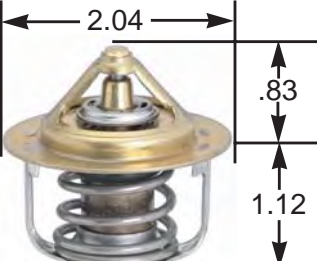

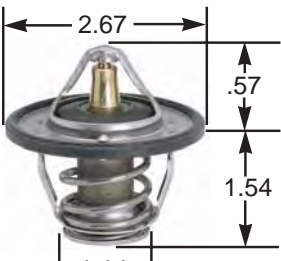
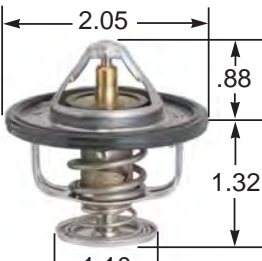
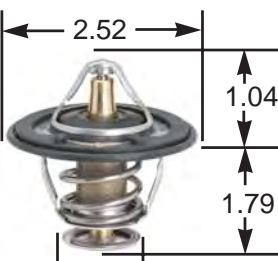
# THERMOSTAT NUMERICAL LISTING (CONTINUED)

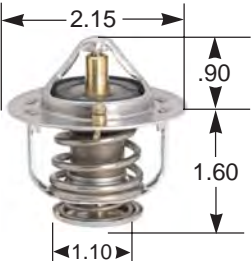
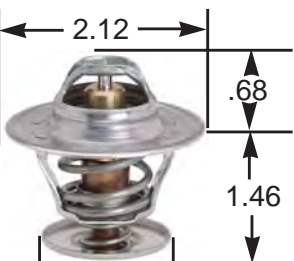
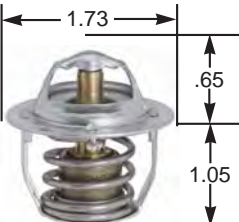
Use as a guide only. Refer to application section for specific vehicle.

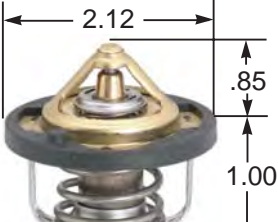
<p><b>48338 180°F</b></p>  <p><b>JIGGLE PIN VALVE IN FLANGE</b></p>	<p><b>48418 180°F</b></p>  <p><b>JIGGLE PIN VALVE IN FLANGE</b></p>	<p><b>48469 190°F</b></p>  <p><b>JIGGLE PIN VALVE IN FLANGE</b></p>
<p><b>48349 192°F</b></p>  <p><b>JIGGLE PIN VALVE IN FLANGE</b></p>	<p><b>48428 180°F</b></p>  <p><b>JIGGLE PIN VALVE IN FLANGE</b></p>	<p><b>48478 180°F</b></p>  <p><b>JIGGLE PIN VALVE IN FLANGE</b></p>
<p><b>48358 180°F</b></p>  <p><b>JIGGLE PIN VALVE IN FLANGE</b></p>	<p><b>48438 180°F</b></p>  <p><b>JIGGLE PIN VALVE IN FLANGE</b></p>	<p><b>48487 170°F</b></p>  <p><b>JIGGLE PIN VALVE IN FLANGE</b></p>
<p><b>48368 180°F</b></p>  <p><b>JIGGLE PIN VALVE IN FLANGE</b></p>	<p><b>48447 170°F</b></p>  <p><b>JIGGLE PIN VALVE IN FLANGE</b></p>	<p><b>48499 190°F</b></p>  <p><b>JIGGLE PIN VALVE IN FLANGE</b></p>
<p><b>48389 185°F</b></p>  <p><b>OFFSET JIGGLE PIN VALVE IN FLANGE</b></p>	<p><b>48457 170°F</b></p>  <p><b>JIGGLE PIN VALVE IN FLANGE</b></p>	<p><b>48508 185°F</b></p>  <p><b>OFFSET JIGGLE PIN VALVE IN FLANGE</b></p>

# THERMOSTAT NUMERICAL LISTING (CONTINUED)

Use as a guide only. Refer to application section for specific vehicle.

48518 180°F

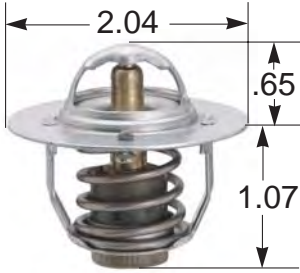

JIGGLE PIN VALVE IN FLANGE

48608 185°F

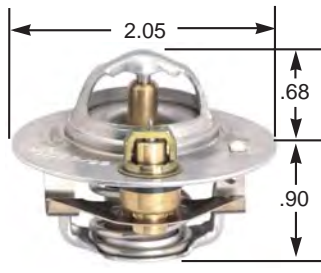

JIGGLE PIN VALVE IN FLANGE

48658 176°F

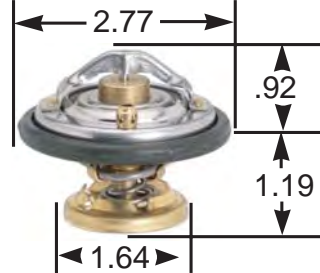

JIGGLE PIN VALVE IN FLANGE

48529 190°F

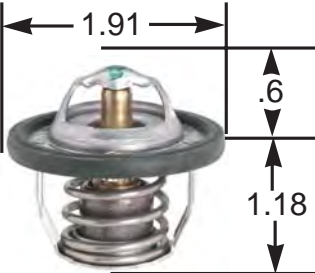

JIGGLE PIN VALVE IN FLANGE

48619 190°F

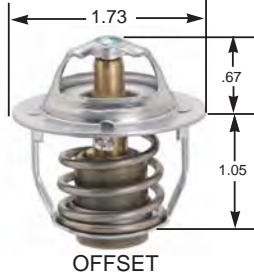

OFFSET  
JIGGLE PIN VALVE IN FLANGE

48668 176°F

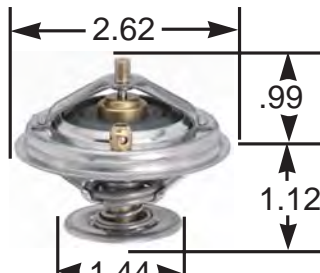

CHECK VALVE IN FLANGE

48539 195°F

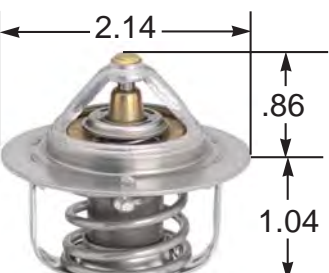

JIGGLE PIN VALVE IN FLANGE

48628 180°F

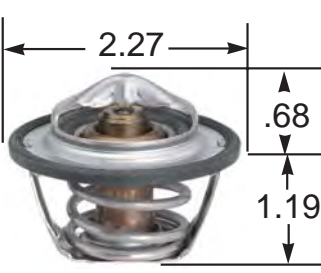

JIGGLE PIN VALVE IN FLANGE

48672 208°F



CHECK VALVE IN FLANGE

48588 180°F

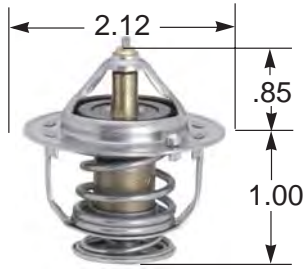

JIGGLE PIN VALVE IN FLANGE

48639 194°F

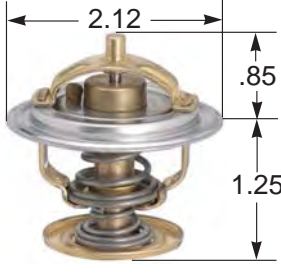

JIGGLE PIN VALVE IN FLANGE

48689 194°F



CHECK VALVE IN FLANGE

48597 170°F

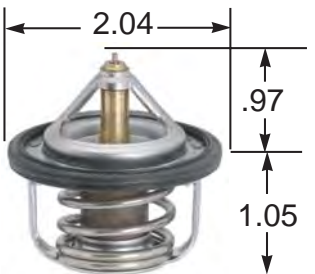

JIGGLE PIN VALVE IN FLANGE

48648 176°F

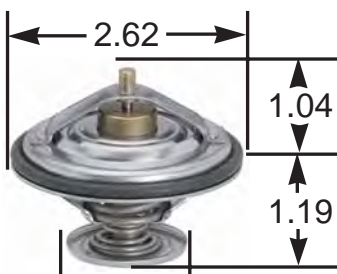

JIGGLE PIN VALVE IN FLANGE

48708 180°F



CHECK VALVE IN FLANGE

# THERMOSTAT NUMERICAL LISTING (CONTINUED)

Use as a guide only. Refer to application section for specific vehicle.

<p><b>48718 180°F</b></p>  <p><b>CHECK VALVE IN FLANGE</b></p>	<p><b>48767 172°F</b></p>  <p><b>JIGGLE PIN VALVE IN FLANGE</b></p>	<p><b>48818 180°F</b></p>  <p><b>CHECK VALVE IN FLANGE</b></p>
<p><b>48728 180°F</b></p>  <p><b>CHECK VALVE IN FLANGE</b></p>	<p><b>48778 180°F</b></p>  <p><b>JIGGLE PIN VALVE IN FLANGE</b></p>	<p><b>48829 194°F</b></p>  <p><b>JIGGLE PIN VALVE IN FLANGE</b></p>
<p><b>48732 202°F</b></p>  <p><b>CHECK VALVE IN FLANGE</b></p>	<p><b>48788 180°F</b></p>  <p><b>CHECK VALVE IN FLANGE</b></p>	<p><b>48839 194°F</b></p>  <p><b>JIGGLE PIN VALVE IN FLANGE</b></p>
<p><b>48747 172°F</b></p>  <p><b>JIGGLE PIN VALVE IN FLANGE</b></p>	<p><b>48792 203°F   48799 190°F</b></p>  <p><b>JIGGLE PIN IN VALVE</b></p>	<p><b>49098 189°F   49099 180°F</b></p> 
<p><b>48759 198°F</b></p> 	<p><b>48808 185°F</b></p>  <p><b>JIGGLE PIN VALVE IN FLANGE</b></p>	<p><b>49108 180°F</b></p> 

# THERMOSTAT NUMERICAL LISTING (CONTINUED)

Use as a guide only. Refer to application section for specific vehicle.

**49200** 203°F and 192°F



**49269** 207°F



**49212** 200°F | **49218** 180°F | **49219** 190°F

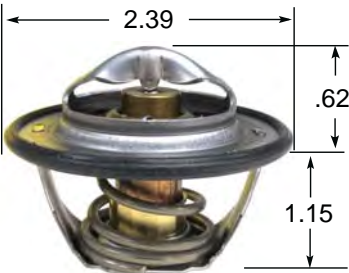

**49279** 192°F



**49229** 188°F | **49238** 190°F

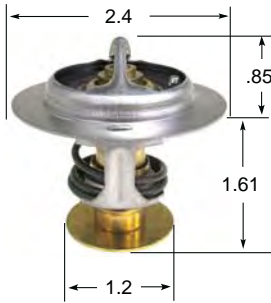

**49288** 180°F

Too New  
For Photo

**49240** 194°F and 201°F

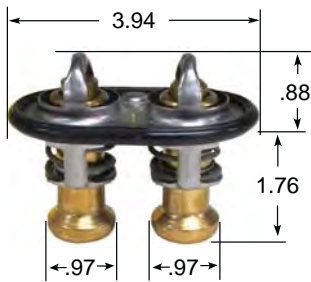

**49299** 221°F



**49258** 189°F

